

International Energy Agency

# Energy Master Planning for Resilient Public Communities – Case Studies

Energy in Buildings and Communities  
Technology Collaboration Programme

January 2021



EBC is a programme of the International Energy Agency (IEA)

International Energy Agency

## Energy Master Planning For Resilient Public Communities – Case Studies

---

Editors:

Anna Maria Fulterer, Ingo Leusbrock, AEE INTEC, Austria

Contributors:

**Behzad Rismanchi**; University of Melbourne, Australia

**Caroline Frauenstein**; James Cook University, Australia

**Anna Maria Fulterer**; AEE INTEC, Austria

**Ingo Leusbrock**; AEE INTEC, Austria

**Dirk Jäger, Maximilian Pammer, Peter Kern, Gert Widu**; BIG GmbH, Austria

**Anders N. Andersen**; EMD, Denmark

**Jens Peter Sandemand**; Danish Defense, Denmark

**Anders Dyrelund**; Ramboll, Denmark

**Henrik Steffensen**; Ramboll, Denmark

**Oddgeir Gudmundsson**; Danfoss, Denmark

**Paul Holt**; UBC, Canada

**Joshua Wauthy**; UBC, Canada

**Ursula Eicker**; Concordia University, Canada

**Pekka Tuominen**; VTT, Finland

**Esa Nykänen**; VTT, Finland

**Francesco Reda**; VTT, Finland

**Zarrin Fatima**; VTT, Finland

**Mikko Martikka**; City of Helsinki, Finland

**Verena Weiler**; HFT Stuttgart, Germany

**Sally Köhler**; HFT Stuttgart, Germany

**Jonas L. Stave**; HFT Stuttgart, Germany

**Annette Roser**; IREES, Germany  
**Karin Schakib-Ekbatan**; IREES, Germany  
**Rüdiger Lohse**; KEA, Germany  
**Natasa Nord**; NTNU, Norway  
**Yiyu Ding**; NTNU, Norway  
**Sarah Zaleski**; U.S. Department of Energy, USA  
**Tony Tubiolo**; U.S. Department of Energy, USA  
**Marcy Loughran**; Denver government, USA  
**Mike Richardson**; St. Paul City Planner, USA  
**Menaka Mohan**; St. Paul City Planner, USA  
**Laxmi J. Rao**; Senior Director, International District Energy Association, USA  
**Joshua Wauthy**; Utility Systems Specialist, University of British Columbia, USA  
**Joseph Yonkoski**; Associate Engineer, Utilities Data & Engineering, UC Davis, Facilities, USA  
**Juan Ontiveros**; Associate Vice President for Utilities, Energy and Facilities Management, University of Texas at Austin, USA  
**Paul Holt**; General Manager, Energy Services Canada, Corix Utilities Inc., Canada (prev: Director, Utilities and Engineering, University of British Columbia)  
**Angela Urban**; US Army Engineer Research and Development Center, USA  
**Elizabeth Keysar**, CTC, USA  
**Avinash Srivastava**, AECOM, USA  
**Michael Case**; US Army Engineer Research and Development Center, USA  
**Alexander Zhivov**; US Army Engineer Research and Development Center, USA  
**Calum Thompson P.E.**; AECOM, USA

© 2021, Copyright IEA EBC Annex 73 Operating Agents 2017

All property rights, including copyright, are vested in IEA EBC Annex 73 Operating Agents 2017, on behalf of the Contracting Parties of the International Energy Agency Implementing Agreement for a Programme of Research and Development on Energy in Buildings and Communities.

In particular, no part of this publication may be reproduced, stored in a retrieval system or transmitted in any form or by any means, electronic, mechanical, photocopying, recording, or otherwise, without the prior written permission of IEA EBC Annex 73 Operating Agents 2017.

Published by AEE GmbH

Disclaimer Notice: This publication has been compiled with reasonable skill and care. However, neither IEA EBC Annex 73 Operating Agents 2017 nor the Contracting Parties of the International Energy Agency Implementing Agreement for a Programme of Research and Development on Energy in Buildings and Communities make any representation as to the adequacy or accuracy of the information contained herein, or as to its suitability for any particular application, and accept no responsibility or liability arising out of the use of this publication. The information contained herein does not supersede the requirements given in any national codes, regulations, or standards, and should not be regarded as a substitute for the need to obtain specific professional advice for any particular application.

ISBN 978-3-901425-14-1

Participating countries in EBC:

Australia, Austria, Belgium, Canada, P.R. China, Czech Republic, Denmark, France, Germany, Ireland, Italy, Japan, Republic of Korea, the Netherlands, New Zealand, Norway, Portugal, Singapore, Spain, Sweden, Switzerland, United Kingdom, and the United States of America.

Additional copies of this report may be obtained from:

EBC Bookshop  
C/o AECOM Ltd  
The Colmore Building  
Colmore Circus Queensway  
Birmingham B4 6AT  
United Kingdom  
Web: [www.IEA EBC.org](http://www.IEA EBC.org)  
Email: [essu@IEA EBC.org](mailto:essu@IEA EBC.org)

and from the web:

<https://annex73.iea-ebc.org/>  
<https://www.iea-annex73.org/annex-73/about/>

## Preface

### **THE INTERNATIONAL ENERGY AGENCY**

The International Energy Agency (IEA) was established in 1974 within the framework of the Organization for Economic Cooperation and Development (OECD) to implement an international energy programme. A basic aim of the IEA is to foster international cooperation among the 29 IEA participating countries and to increase energy security through energy research, development, and demonstration in the fields of technologies for energy efficiency and renewable energy sources.

### **THE IEA ENERGY IN BUILDINGS AND COMMUNITIES PROGRAMME**

The IEA coordinates international energy research and development (R&D) activities through a comprehensive portfolio of Technology Collaboration Programmes. The mission of the IEA Energy in Buildings and Communities (IEA EBC) Programme is to develop and facilitate the integration of technologies and processes for energy efficiency and conservation into healthy, low-emission, and sustainable buildings and communities through innovation and research. (Until March 2013, the IEA EBC Programme was known as the IEA Energy in Buildings and Community Systems Programme, ECBCS.)

The R&D strategies of the IEA EBC Programme are derived from research drivers, national programmes within IEA countries, and the IEA Future Buildings Forum Think Tank Workshops. These R&D strategies aim to exploit technological opportunities to save energy in the buildings sector, and to remove technical obstacles to market penetration of new energy-efficient technologies. The R&D strategies apply to residential, commercial, office buildings and community systems, and will impact the building industry in five areas of focus for R&D activities:

- Integrated planning and building design
- Building energy systems
- Building envelope
- Community scale methods
- Real building energy use.

### **THE EXECUTIVE COMMITTEE**

Overall control of the IEA EBC Programme is maintained by an Executive Committee, which not only monitors existing projects, but also identifies new strategic areas in which collaborative efforts may be beneficial. As the Programme is based on a contract with the IEA, the projects are legally established as Annexes to the IEA EBC Implementing Agreement. At the present time, the following projects have been initiated by the IEA EBC Executive Committee, with completed projects identified by (\*):

- Annex 1: Load Energy Determination of Buildings (\*)
- Annex 2: Ekistics and Advanced Community Energy Systems (\*)
- Annex 3: Energy Conservation in Residential Buildings (\*)
- Annex 4: Glasgow Commercial Building Monitoring (\*)
- Annex 5: Air Infiltration and Ventilation Centre
- Annex 6: Energy Systems and Design of Communities (\*)

Annex 7: Local Government Energy Planning (\*)  
Annex 8: Inhabitants Behaviour with Regard to Ventilation (\*)  
Annex 9: Minimum Ventilation Rates (\*)  
Annex 10: Building HVAC System Simulation (\*)  
Annex 11: Energy Auditing (\*)  
Annex 12: Windows and Fenestration (\*)  
Annex 13: Energy Management in Hospitals (\*)  
Annex 14: Condensation and Energy (\*)  
Annex 15: Energy Efficiency in Schools (\*)  
Annex 16: BEMS 1 – User Interfaces and System Integration (\*)  
Annex 17: BEMS 2 – Evaluation and Emulation Techniques (\*)  
Annex 18: Demand Controlled Ventilation Systems (\*)  
Annex 19: Low Slope Roof Systems (\*)  
Annex 20: Air Flow Patterns within Buildings (\*)  
Annex 21: Thermal Modelling (\*)  
Annex 22: Energy Efficient Communities (\*)  
Annex 23: Multi-Zone Air Flow Modelling (COMIS) (\*)  
Annex 24: Heat, Air and Moisture Transfer in Envelopes (\*)  
Annex 25: Real time HVAC Simulation (\*)  
Annex 26: Energy Efficient Ventilation of Large Enclosures (\*)  
Annex 27: Evaluation and Demonstration of Domestic Ventilation Systems (\*)  
Annex 28: Low Energy Cooling Systems (\*)  
Annex 29: Daylight in Buildings (\*)  
Annex 30: Bringing Simulation to Application (\*)  
Annex 31: Energy-Related Environmental Impact of Buildings (\*)  
Annex 32: Integral Building Envelope Performance Assessment (\*)  
Annex 33: Advanced Local Energy Planning (\*)  
Annex 34: Computer-Aided Evaluation of HVAC System Performance (\*)  
Annex 35: Design of Energy Efficient Hybrid Ventilation (HYBVENT) (\*)  
Annex 36: Retrofitting of Educational Buildings (\*)  
Annex 37: Low Exergy Systems for Heating and Cooling of Buildings (LowEx) (\*)  
Annex 38: Solar Sustainable Housing (\*)  
Annex 39: High Performance Insulation Systems (\*)  
Annex 40: Building Commissioning to Improve Energy Performance (\*)  
Annex 41: Whole Building Heat, Air and Moisture Response (MOIST-ENG) (\*)  
Annex 42: The Simulation of Building-Integrated Fuel Cell and Other Cogeneration Systems (FC+COGEN-SIM) (\*)  
Annex 43: Testing and Validation of Building Energy Simulation Tools (\*)  
Annex 44: Integrating Environmentally Responsive Elements in Buildings (\*)  
Annex 45: Energy Efficient Electric Lighting for Buildings (\*)  
Annex 46: Holistic Assessment Tool-kit on Energy Efficient Retrofit Measures for Government Buildings (EnERGo) (\*)  
Annex 47: Cost-Effective Commissioning for Existing and Low Energy Buildings (\*)  
Annex 48: Heat Pumping and Reversible Air-Conditioning (\*)  
Annex 49: Low Exergy Systems for High Performance Buildings and Communities (\*)  
Annex 50: Prefabricated Systems for Low Energy Renovation of Residential Buildings (\*)  
Annex 51: Energy Efficient Communities (\*)  
Annex 52: Towards Net Zero Energy Solar Buildings (\*)

Annex 53: Total Energy Use in Buildings: Analysis and Evaluation Methods (\*)  
Annex 54: Integration of Micro-Generation and Related Energy Technologies in Buildings (\*)  
Annex 55: Reliability of Energy Efficient Building Retrofitting – Probability Assessment of Performance and Cost (RAP-RETRO) (\*)  
Annex 56: Cost-Effective Energy and CO<sub>2</sub> Emissions Optimization in Building Renovation  
Annex 57: Evaluation of Embodied Energy and CO<sub>2</sub> Equivalent Emissions for Building Construction (\*)  
Annex 58: Reliable Building Energy Performance Characterization Based on Full Scale Dynamic Measurements (\*)  
Annex 59: High Temperature Cooling and Low Temperature Heating in Buildings (\*)  
Annex 60: New Generation Computational Tools for Building and Community Energy Systems  
Annex 61: Business and Technical Concepts for Deep Energy Retrofit of Public Buildings  
Annex 62: Ventilative Cooling  
Annex 63: Implementation of Energy Strategies in Communities  
Annex 64: LowEx Communities – Optimized Performance of Energy Supply Systems with Exergy Principles  
Annex 65: Long-Term Performance of Super-Insulating Materials in Building Components and Systems  
Annex 66: Definition and Simulation of Occupant Behavior in Buildings  
Annex 67: Energy Flexible Buildings  
Annex 68: Indoor Air Quality Design and Control in Low Energy Residential Buildings  
Annex 69: Strategy and Practice of Adaptive Thermal Comfort in Low Energy Buildings  
Annex 70: Energy Epidemiology: Analysis of Real Building Energy Use at Scale  
Annex 71: Building Energy Performance Assessment Based on In-situ Measurements  
Annex 72: Assessing Life Cycle Related Environmental Impacts Caused by Buildings  
Annex 73: Towards Net Zero Energy Public Communities  
Annex 74: Energy Endeavour  
Annex 75: Cost-effective Building Renovation at District Level Combining Energy Efficiency and Renewables  
Working Group – Energy Efficiency in Educational Buildings (\*)  
Working Group – Indicators of Energy Efficiency in Cold Climate Buildings (\*)  
Working Group – Annex 36 Extension: The Energy Concept Adviser (\*)  
Working Group – HVAC Energy Calculation Methodologies for Non-residential Buildings



## Acknowledgements

The “Energy Master Planning for Resilient Public Communities – Case Studies” book was developed within the IEA EBC Program Annex 73, as the result of a joint effort by researchers and practitioners from Australia, Austria, Denmark, Estonia, Finland, Germany, Norway, the United Kingdom, and the United States. The authors express their appreciation to the many international contributors and organizations, whose volunteer efforts made possible the development of this practical document. Special gratitude is owed to the American Society of Heating, Refrigerating, and Air-Conditioning Engineers (ASHRAE) and its Technical Committees TC 7.6 “Building Energy Performance,” The U.S. National Academies’ of Sciences and Medicine Federal Facilities Council, and the Environmental Security Technology Certification Program (ESTCP) for providing a platform for public discussion of the project’s progress and for the review of the document by its members. The authors would like to personally thank the members of the EBC Program Executive Committee for providing direction, guidance, and support to the project. Special appreciation is owed to the following reviewers, who provided their valuable comments and suggested improvements to this book:

We acknowledge the financial and further support for the Austrian contributions to IEA EBC Annex 73 as part of the national research project, IEA EBC Annex 73 “Hin zu resilienten öffentlichen ‘Niedrigstenergie’ Gebäudeverbänden und Siedlungen” (FFG project number 864147), the Department of Infrastructure Engineering at The University of Melbourne, Australia; from the Research Council of Norway (Methods for Transparent Energy Planning of Urban Building Stocks - ExPOSe (project number 268248) under EnergiX program and from ENOVA (the Norwegian Energy efficiency agency); the Danish Energy Agency; from the Academy of Finland Strategic Research Council (SRC) project: Smart Energy Transition (SET) – Realizing Its Potential for Sustainable Growth for Finland’s Second Century, Decision No. 314325, MySmartLife project that has received funding from the European Union’s Horizon 2020 research and innovation programme under grant agreement No 731297 and SunZEB project funded by Helen Ltd., Finnish Energy Association, Fortum Ltd., city of Helsinki, Hyvinkään Lämpövoima Ltd., Projectus Team Ltd., Confederation of Finnish Construction Industries, Senaattikiinteistöt Ltd., Skaala Ltd., Tampereen Sähkölaitos Ltd., Turku Energia Ltd., Uponor Ltd. and Ministry of Economic Affairs and Employment of Finland, the German Department of Economic Affairs and Energy in the context of the 6<sup>th</sup> Energy Research Program and by approval by the German Bundestag, the U.S. Department of Defense Environmental Security Technology Certification Program; the office of the Assistant Secretary of the U.S. Army for Installations, Energy, and Environment; U.S. Army Corps of Engineers; and the U.S. Department of Energy (Office of Building Technologies and Federal Energy Management Program).

The authors gratefully acknowledge William J. Wolfe, Writer-Editor, ERDC-CERL for his help in coordinating preparation of this document.

## List of contributions

Case No.	Country	Location	Contributors	Contact
1	Australia	Townsville	Behzad Rismanchi, Melbourne School of Engineering	<a href="mailto:behzad.rismanchi@unimelb.edu.au">behzad.rismanchi@unimelb.edu.au</a>
2	Australia	Cairns	Behzad Rismanchi, Melbourne School of Engineering	<a href="mailto:behzad.rismanchi@unimelb.edu.au">behzad.rismanchi@unimelb.edu.au</a>
3	Austria	Innsbruck	Anna Maria Fulterer, Ingo Leusbrock, AEE INTEC	<a href="mailto:a.m.fulterer@aee.at">a.m.fulterer@aee.at</a> <a href="mailto:i.leusbrock@aee.at">i.leusbrock@aee.at</a>
4	Austria	Vienna	Anna Maria Fulterer, Ingo Leusbrock, AEE INTEC	<a href="mailto:a.m.fulterer@aee.at">a.m.fulterer@aee.at</a> <a href="mailto:i.leusbrock@aee.at">i.leusbrock@aee.at</a>
5	Denmark	Skrydstrup	Anders Dryelund, Ramboll	<a href="mailto:AD@ramboll.com">AD@ramboll.com</a>
6	Denmark	Taarby	Anders Dryelund, Ramboll	<a href="mailto:AD@ramboll.com">AD@ramboll.com</a>
7	Denmark	Taarby	Anders Dryelund, Ramboll	<a href="mailto:AD@ramboll.com">AD@ramboll.com</a>
8	Denmark	Greater Copenhagen	Anders Dryelund, Ramboll	<a href="mailto:AD@ramboll.com">AD@ramboll.com</a>
9	Denmark	Vestfor-brænding	Anders Dryelund, Ramboll	<a href="mailto:AD@ramboll.com">AD@ramboll.com</a>
10	Denmark	DTU Close to Copenhagen	Anders Dryelund, Ramboll	<a href="mailto:AD@ramboll.com">AD@ramboll.com</a>
11	Denmark, Greenland	Quaanaap	Anders Dryelund, Ramboll	<a href="mailto:AD@ramboll.com">AD@ramboll.com</a>
12	Denmark	Danfoss Campus	Oddgeir Gudmundsson, Danfoss A/S, Jørgen Rose, Aalborg University	<a href="mailto:og@danfoss.com">og@danfoss.com</a> <a href="mailto:iro@build.aau.dk">iro@build.aau.dk</a>
13	Denmark	Favrholm	Anders Dryelund, Ramboll	<a href="mailto:AD@ramboll.com">AD@ramboll.com</a>
14	Denmark	Gram	Anders Dryelund, Ramboll	<a href="mailto:AD@ramboll.com">AD@ramboll.com</a>
15	Finland	Helsinki Kalasatama	Reda Francesco (VTT), Pekka Tuominen (VTT), Hassam ur Rehman (VTT)	<a href="mailto:Francesco.Red@vtt.fi">Francesco.Red@vtt.fi</a> <a href="mailto:Pekka.Tuominen@vtt.fi">Pekka.Tuominen@vtt.fi</a> <a href="mailto:Hassam.Rehman@vtt.fi">Hassam.Rehman@vtt.fi</a>

16	Finland	Merihaka	Reda Francesco (VTT), Pekka Tuominen (VTT), Hassam ur Rehman (VTT)	<a href="mailto:Francesco.Red@vtt.fi">Francesco.Red@vtt.fi</a> <a href="mailto:Pekka.Tuominen@vtt.fi">Pekka.Tuominen@vtt.fi</a> <a href="mailto:Hassam.Rehman@vtt.fi">Hassam.Rehman@vtt.fi</a>
17	Finland	Helsinki Esplanadi Park	Reda Francesco (VTT), Pekka Tuominen (VTT), Hassam ur Rehman (VTT)	<a href="mailto:Francesco.Red@vtt.fi">Francesco.Red@vtt.fi</a> <a href="mailto:Pekka.Tuominen@vtt.fi">Pekka.Tuominen@vtt.fi</a> <a href="mailto:Hassam.Rehman@vtt.fi">Hassam.Rehman@vtt.fi</a>
18	Finland	Helsinki Katri Vala	Reda Francesco (VTT), Pekka Tuominen (VTT), Hassam ur Rehman (VTT)	<a href="mailto:Francesco.Red@vtt.fi">Francesco.Red@vtt.fi</a> <a href="mailto:Pekka.Tuominen@vtt.fi">Pekka.Tuominen@vtt.fi</a> <a href="mailto:Hassam.Rehman@vtt.fi">Hassam.Rehman@vtt.fi</a>
19	Finland	Helsinki Mustik-kamaan	Reda Francesco (VTT), Pekka Tuominen (VTT), Hassam ur Rehman (VTT)	<a href="mailto:Francesco.Red@vtt.fi">Francesco.Red@vtt.fi</a> <a href="mailto:Pekka.Tuominen@vtt.fi">Pekka.Tuominen@vtt.fi</a> <a href="mailto:Hassam.Rehman@vtt.fi">Hassam.Rehman@vtt.fi</a>
20	Finland	Helsinki Kruunuvuori	Reda Francesco (VTT), Pekka Tuominen (VTT), Hassam ur Rehman (VTT)	<a href="mailto:Francesco.Red@vtt.fi">Francesco.Red@vtt.fi</a> <a href="mailto:Pekka.Tuominen@vtt.fi">Pekka.Tuominen@vtt.fi</a> <a href="mailto:Hassam.Rehman@vtt.fi">Hassam.Rehman@vtt.fi</a>
21	Germany	Stuttgart	Verena Weiler (HFT Stuttgart, Steinbeis Locasys), Jonas Stave (HFT Stuttgart)	<a href="mailto:verena.weiler@hft-stuttgart.de">verena.weiler@hft-stuttgart.de</a> <a href="mailto:jonas.stave@hft-stuttgart.de">jonas.stave@hft-stuttgart.de</a>
22	Germany	Detmold	Annette Roser, Karin Schakib-Ekbatan (IREES) Verena Weiler, Ursula Eicker (HFT) Rüdiger Lohse (KEA)	<a href="mailto:verena.weiler@hft-stuttgart.de">verena.weiler@hft-stuttgart.de</a> <a href="mailto:ruediger.lohse@kea-bw.de">ruediger.lohse@kea-bw.de</a>
23	Germany	Karlsruhe Rintheim	Annette Roser, Karin Schakib-Ekbatan (IREES) Verena Weiler, Ursula Eicker (HFT) Rüdiger Lohse (KEA)	<a href="mailto:verena.weiler@hft-stuttgart.de">verena.weiler@hft-stuttgart.de</a> <a href="mailto:ruediger.lohse@kea-bw.de">ruediger.lohse@kea-bw.de</a>
24	USA	Guam	Angela Urban, Elizabeth Keysar, Kathleen Judd, Avinash Srivastava, Calum Thompson, Michael Case, Alexander Zhivov (US Army)	
25	USA	Texas Fort Bliss	Angela Urban, Elizabeth Keysar,	

			Kathleen Judd, Avinash Srivastava, Calum Thompson, Michael Case, Alexander Zhivov (US Army)	
26	USA	Denver National Western Center	Tony Tubiolo (US DOE), Marcy Loughran (Denver Gov)	<a href="mailto:tony.tubiolo@ee.doe.gov">tony.tubiolo@ee.doe.gov</a> <a href="mailto:Marcy.Loughran@denvergov.org">Marcy.Loughran@denvergov.org</a>
27	USA	St. Paul	Tony Tubiolo, Sarah Zaleski (US DOE), Mike Richardson, Menaka Mohan (St Paul City Planner)	<a href="mailto:tony.tubiolo@ee.doe.gov">tony.tubiolo@ee.doe.gov</a>
28	USA	Austin	Laxmi Rao (IDEA) Juan Ontiveros (UT Austin)	<a href="mailto:laxmi.idea@districtenergy.org">laxmi.idea@districtenergy.org</a> <a href="mailto:juan.ontiveros@austin.utexas.edu">juan.ontiveros@austin.utexas.edu</a>
29	USA	Davis	Laxmi Rao (IDEA), Joseph Yonkoski (UC Davis)	<a href="mailto:laxmi.idea@districtenergy.org">laxmi.idea@districtenergy.org</a> , <a href="mailto:jkyonkoski@ucdavis.edu">jkyonkoski@ucdavis.edu</a>
30	Canada	Vancouver	Laxmi Rao (IDEA), Joshua Wauthy and Paul Holt (UBC)	<a href="mailto:laxmi.idea@districtenergy.org">laxmi.idea@districtenergy.org</a> <a href="mailto:joshua.wauthy@ubc.ca">joshua.wauthy@ubc.ca</a> <a href="mailto:paul.holt@ubc.ca">paul.holt@ubc.ca</a>
31	USA	Fort Bragg	Angela Urban, Elizabeth Keysar, Kathleen Judd, Avinash Srivastava, Calum Thompson, Michael Case, Alexander Zhivov (US Army)	
32	Norway	Trondheim	Natasa Nord, Yiyu Ding, Norwegian University of Science and Technology	<a href="mailto:natasa.nord@ntnu.no">natasa.nord@ntnu.no</a> <a href="mailto:yiyu.ding@ntnu.no">yiyu.ding@ntnu.no</a>

# Table of Contents

Preface .....	iv
Acknowledgements .....	vii
List of contributions.....	viii
Figures and Tables .....	xvii
Executive Summary .....	xxvi
Chapter 1. INTRODUCTION .....	29
Chapter 2. CASE STUDY OVERVIEW .....	31
Chapter 3. CATEGORIZATION OF CASE STUDIES .....	36
3.1 Energy System and Climate	36
3.2 Drivers	41
3.3 Financing and Business Models	42
Chapter 4. LESSONS LEARNED FROM CASE STUDIES .....	45
4.1 Success factors	45
4.2 Bottlenecks	47
4.3 Lessons learned	48
Chapter 5. LESSONS LEARNED ON ENERGY MASTER PLANNING .....	49
5.1 Resiliency Analysis and Gap Evaluation	49
5.2 Organizational Matters	51
5.3 Financing/Economics	52
5.4 Framework	54
5.5 Technology	55
5.6 District Energy Systems	57
5.6.1 <i>Advantages of district heating and cooling</i>	57
5.7 Planning	58
5.8 Motivation/Mobilization	61
5.9 Current trends and future solutions	62
Chapter 6. CASE STUDIES.....	65
6.1 James Cook University Townsville Campus District Cooling System with Thermal Energy Storage, Australia	65
6.1.1 <i>Background and Framework</i>	65
6.1.2 <i>Innovative Solution</i>	66
6.1.3 <i>Decision and Design Process</i>	69
6.1.4 <i>Resilience</i>	70
6.1.5 <i>Lessons Learned</i>	71
6.2 James Cook University Cairns Campus District Cooling System with Thermal Energy Storage, Australia	71
6.2.1 <i>Background and Framework</i>	72
6.2.2 <i>Energy Objectives</i>	73

6.2.3 <i>Decision and Design Process</i>	75
6.2.4 <i>Resilience</i>	76
6.2.5 <i>Lessons Learned</i>	77
6.3 University of Innsbruck – Technology Campus. Renovation of Two Buildings and Their Auxiliary Buildings, Austria	77
6.3.1 <i>Background and Framework</i>	79
6.3.2 <i>Energy Objectives</i>	81
6.3.3 <i>Innovative Approach</i>	82
6.3.4 <i>Decision and Design Process</i>	84
6.3.5 <i>Resilience</i>	87
6.3.6 <i>Lessons Learned</i>	88
6.4 WU Vienna, Austria	89
6.4.1 <i>Background and Framework</i>	89
6.4.2 <i>Energy Objectives</i>	91
6.4.3 <i>Innovative use of Ground Water</i>	92
6.4.4 <i>Decision and Design Process</i>	93
6.4.5 <i>Resilience</i>	95
6.4.6 <i>Lessons Learned</i>	96
6.5 Air Base Skrydstrup in Denmark	97
6.5.1 <i>Background and Framework</i>	97
6.5.2 <i>Innovation: CHP using Local Biogas</i>	100
6.5.3 <i>Resilience in the Future Energy System at Skrydstrup Air Base</i>	101
6.6 District Heating Based on CHP and Waste Heat in Taarnby, Denmark	102
6.6.1 <i>Background and Framework</i>	102
6.6.2 <i>Energy Objectives</i>	104
6.6.3 <i>Technical Highlight</i>	106
6.6.4 <i>Decision and Design Process</i>	108
6.6.5 <i>Resilience</i>	111
6.6.6 <i>Lessons Learned</i>	111
6.7 District Cooling in Symbiosis with District Heating and Wastewater in Taarnby, Denmark	112
6.7.1 <i>Background and Framework</i>	112
6.7.2 <i>Energy Objectives</i>	114
6.7.3 <i>Decision and Design Process</i>	119
6.7.4 <i>Resilience</i>	122
6.7.5 <i>Lessons Learned</i>	122
6.8 District Energy in Greater Copenhagen, Denmark	123
6.8.1 <i>Background and Framework</i>	123
6.8.2 <i>Energy Objectives</i>	124
6.8.3 <i>The Planning Process for District Heating</i>	125
6.8.4 <i>Project Technical Information</i>	128
6.8.5 <i>Technical Highlights</i>	134
6.8.6 <i>Decision and design process</i>	135
6.8.7 <i>Resilience</i>	140
6.8.8 <i>Lessons Learned</i>	140
6.9 District Energy from Waste for Vestforbrænding, Denmark	141
6.9.1 <i>Background and Framework</i>	141

6.9.2 <i>Highlight: Heat Supply Planning</i>	142
6.9.3 <i>Objectives: Energy Plan 2035</i>	143
6.9.4 <i>Project Technical Information</i>	144
6.9.5 <i>Decision and Design Process</i>	147
6.9.6 <i>Resilience</i>	149
6.9.7 <i>Lessons Learned</i>	150
6.10 <i>University Campus of Technical University of Denmark (DTU), Denmark</i>	150
6.10.1 <i>Background and Framework</i>	151
6.10.2 <i>Energy Objectives of the DTU Campus</i>	152
6.10.3 <i>The Campus Projects at DTU in Lyngby-Taarbæk Municipality</i>	153
6.10.4 <i>Technical Highlight</i>	159
6.10.5 <i>Decision and Design Process</i>	161
6.10.6 <i>Resilience</i>	163
6.10.7 <i>Lessons Learned</i>	163
6.11 <i>District Qaanaap in Greenland, Denmark</i>	164
6.11.1 <i>Background and Framework</i>	164
6.11.2 <i>Decision and Design Process</i>	168
6.11.3 <i>Resilience</i>	169
6.11.4 <i>Lessons Learned</i>	169
6.12 <i>Company Campus of Danfoss, Denmark</i>	170
6.12.1 <i>Background and Framework</i>	170
6.12.2 <i>Energy Objectives</i>	174
6.12.3 <i>Technical Highlights and Efficiency Measures</i>	175
6.12.4 <i>Decision and Design Process</i>	177
6.12.5 <i>Resilience</i>	178
6.12.6 <i>Lessons Learned</i>	179
6.13 <i>Energy Planning in Urban Development Favrholt, Denmark</i>	180
6.13.1 <i>Background and Framework</i>	180
6.13.2 <i>Energy Objectives</i>	181
6.13.3 <i>The Planning Process and Methodology</i>	181
6.13.4 <i>Technical and Organizational Highlights</i>	185
6.13.5 <i>Decision and Design Process</i>	190
6.13.6 <i>Resilience</i>	192
6.13.7 <i>Lessons Learned</i>	192
6.14 <i>Gram District Heating Solar Heat, Storage Pit, Denmark</i>	193
6.14.1 <i>Background and Framework</i>	193
6.14.2 <i>Energy Objectives</i>	194
6.14.3 <i>The Historical Development</i>	194
6.14.4 <i>Description of a Technical Highlight</i>	197
6.14.5 <i>Decision and Design Process</i>	198
6.14.6 <i>Resilience</i>	199
6.14.7 <i>Lessons Learned</i>	200
6.15 <i>Nymindegab Military Camp in Denmark</i>	200
6.15.1 <i>Background and Framework</i>	200
6.15.2 <i>Resilience in the Energy System at Nymindegab Military Camp</i>	203
6.15.3 <i>Lessons Learned</i>	205

6.16 SunZEB Building for Energy Harvesting, Finland	205
6.16.1 <i>Introduction and Framework</i>	205
6.16.2 <i>Energy Market Context</i>	207
6.16.3 <i>Technical Highlight</i>	209
6.16.4 <i>Decision and Design Process</i>	210
6.16.5 <i>Resilience</i>	212
6.16.6 <i>Lessons Learned</i>	213
6.17 Horizon 2020 Lighthouse Project mySMARTLife - Actions in Merihaka Retrofitting Area, Finland	214
6.17.1 <i>Background and Framework</i>	214
6.17.2 <i>Outcomes</i>	217
6.17.3 <i>Highlight</i>	218
6.17.4 <i>Decision and Design Process</i>	219
6.17.5 <i>Resilience</i>	220
6.17.6 <i>Lessons Learned</i>	221
6.18 Underground District Heating and Cooling Plant Located in Esplanade Uses Waste Heat; Helsinki, Finland	221
6.18.1 <i>Background and Framework</i>	222
6.18.2 <i>Technical Highlight and Motivation</i>	223
6.19 Katri Vala – A Mega Heating and Cooling Plant; Helsinki, Finland	224
6.19.1 <i>Background and Framework</i>	224
6.19.2 <i>Highlight and Motivation</i>	226
6.20 Finland’s Largest Heat Storage Facility to Be Constructed in Old Oil Caverns in Mustikkamaa Area Located in Helsinki, Finland	227
6.20.1 <i>Background and Framework</i>	227
6.20.2 <i>Technical Highlight and Motivation</i>	229
6.21 World’s First and Largest Seasonal Storage in Old Rock Caverns: Kruunuvuori, Finland	230
6.21.1 <i>Background and Framework</i>	230
6.21.2 <i>Technical highlight and motivation</i>	232
6.22 University Campus in Stuttgart, Germany	233
6.22.1 <i>Background and Framework</i>	233
6.22.2 <i>Energy Market Context</i>	235
6.22.3 <i>Energy Objectives</i>	235
6.22.4 <i>Status of Development</i>	236
6.22.5 <i>Technical Highlight</i>	238
6.22.6 <i>Decision and Design Process</i>	240
6.22.7 <i>Resilience</i>	243
6.22.8 <i>Lessons Learned</i>	244
6.23 School Campus in Detmold, Germany	245
6.23.1 <i>Background and Framework</i>	245
6.23.2 <i>Energy Targets</i>	246
6.24 Rinheim District in Karlsruhe, Germany	248
6.24.1 <i>Background and Framework</i>	249
6.24.2 <i>Results from Monitoring Phase</i>	250
6.25 Energy Planning for Military Town in Guam	251
6.25.1 <i>Installation Background</i>	251



6.25.2 <i>Goals and Strategies</i>	254
6.25.3 <i>Highlights</i>	257
6.25.4 <i>Lessons Learned</i>	260
6.26 <i>Military town Fort Bliss in Texas, USA</i>	261
6.26.1 <i>Installation Background and Challenges</i>	261
6.26.2 <i>Existing Infrastructure and Demand</i>	263
6.26.3 <i>Goals and Strategies</i>	264
6.26.4 <i>Highlight: Innovative Risk Assessment</i>	264
6.26.5 <i>Decision and Design Process</i>	267
6.26.6 <i>Resilience</i>	267
6.26.7 <i>Lessons Learned</i>	269
6.26.8 <i>Major Lessons Learned</i>	269
6.27 <i>Denver National Western Center in Denver, Colorado</i>	270
6.27.1 <i>Background and Framework</i>	271
6.27.2 <i>Energy Objectives</i>	272
6.27.3 <i>Technical Highlight</i>	275
6.27.4 <i>Main Innovative Approach</i>	275
6.27.5 <i>Design and Planning Process</i>	277
6.27.6 <i>Financing Issues</i>	278
6.27.7 <i>Technical Issues</i>	278
6.27.8 <i>Lessons Learned</i>	279
6.28 <i>Developing Ford District in St. Paul Minnesota, USA</i>	279
6.28.1 <i>Ford Site: A 21st Century Community</i>	280
6.28.2 <i>Energy Planning</i>	282
6.28.3 <i>Technical Highlight</i>	283
6.28.4 <i>Design and Planning Process</i>	283
6.28.5 <i>Lessons Learned</i>	285
6.29 <i>University Campus in Austin, USA</i>	286
6.29.1 <i>Background and Framework</i>	286
6.29.2 <i>Objectives and Attainment</i>	288
6.29.3 <i>Energy Market Context</i>	290
6.29.4 <i>Technical Highlight</i>	292
6.29.5 <i>Design and Planning Process</i>	293
6.29.6 <i>Resilience</i>	297
6.30 <i>Solar Thermal at the UC Davis California National Primate Research Center</i>	298
6.30.1 <i>Background and Framework</i>	298
6.30.2 <i>Project Objectives</i>	302
6.30.3 <i>Existing Heat and Power Supply</i>	302
6.30.4 <i>Recommended Heat and Cooling Supply</i>	303
6.30.5 <i>Technical Highlight</i>	305
6.30.6 <i>Design and Decision Process</i>	307
6.30.7 <i>Resilience</i>	310
6.30.8 <i>Lessons Learned</i>	311
6.31 <i>The Evolution of Low Carbon District Energy and Innovative Solutions at University of British Columbia</i>	311
6.31.1 <i>Background and Framework</i>	312

6.31.2 <i>Climate &amp; Energy Objectives</i>	315
6.31.3 <i>Innovative Approach to Steam to Hot-Water Conversion</i>	317
6.31.4 <i>Design and Decision Process</i>	320
6.31.5 <i>Resilience</i>	322
6.31.6 <i>Lessons Learned</i>	323
6.32 <i>Energy Planning for Military Town Fort Bragg, USA</i>	324
6.32.1 <i>Installation Background</i>	324
6.32.2 <i>Goals and Strategies</i>	325
6.32.3 <i>Development of the Baseline</i>	325
6.32.4 <i>Innovative Approach in Modeling Resilience</i>	326
6.32.5 <i>Establishing the Base Case and Future Alternatives</i>	328
6.32.6 <i>Measuring Resilience</i>	331
6.32.7 <i>Lessons Learned</i>	331
6.33 <i>Future Energy Pathways for NTNU Gløshaugen Campus, Norway</i>	332
6.33.1 <i>Background and Framework</i>	332
6.33.2 <i>Innovative Approach</i>	338
6.33.3 <i>Decision and Design Process</i>	339
6.33.4 <i>Resilience</i>	341
6.33.5 <i>Lessons Learned</i>	342
Chapter 7. <b>METHODOLOGY</b> .....	<b>343</b>
7.1 <i>Goals</i>	343
7.2 <i>Template</i>	343
7.3 <i>Selection of Appropriate Cases</i>	344
7.4 <i>Case Study Process</i>	345
<b>REFERENCES</b> .....	<b>347</b>
<b>ACRONYMS AND ABBREVIATIONS</b> .....	<b>350</b>

## Figures and Tables

### Figures

Figure 1. Symbols for main characteristics to be used to highlight focus of case studies.	31
Figure 2. Energy system architecture for case study on Quanaaq, Greenland.	39
Figure 3. Energy system architecture for case study on district cooling in Taarnby, Denmark.	39
Figure 4. Energy system architecture for case study on UC Davis, USA.	40
Figure 5. Energy system architecture of the University Campus Technik in Innsbruck (AUT). The system is of type 1.3.4.	40
Figure 6. Detail of classification table from technology database.	41
Figure 7. Tractor providing power to a mountain resort during 3-hour blackout. This is a typical mobile backup method used in agricultural and sparsely populated areas (February 2020, Sommeralm in Austria. Source: AEE INTEC).	50
Figure 8. Townsville chilled-water reticulation.	66
Figure 9. Energy Consumption per month in 2017.	68
Figure 10. University Campus in Cairns; Chilled-water reticulation.	72
Figure 11. Cairns thermal energy for chilled-water consumption.	75
Figure 12. View on the campus of the University of Technology Innsbruck. The marked buildings have been renovated in the described process (Source: basemap.at 2020).	80
Figure 13. Map of the campus area. Source: Tiris - Tiroler Rauminformationssystem © DKM. BEV-Wien ©TIRIS, with additional Information on renovated buildings and location of heat generation (2018)	80
Figure 14. Energy Consumption before modernization.	81
Figure 15. Energy Consumption after modernization.	82
Figure 16. Energy consumption per use type after modernization.	82
Figure 17. Energy system of Campus Technik in Innsbruck (Source: AEE INTEC).	83
Figure 18. Overflow opening in the door/window (Source: PHI – DI Harald Konrad Malzer).	83
Figure 19. Stakeholder structure in Planning Process. Input necessary for whole system resilience analysis is highlighted in italic. Own presentation of data from BIGMODERN project, translated and details added.	85
Figure 20. Overview of the University Campus of the Vienna University of Economics and Business (Source: basemap 2019)	90
Figure 21. Urban embedding of the WU Vienna, between a fair ground and the popular and well-known urban outdoor area “Wurstelprater,” with excellent public transport (Source: Openstreetmap ©Contributors to Openstreetmap).	90
Figure 22. Graphical representation of energy demand.	91
Figure 23. Graphical representation of energy supply.	92
Figure 24. Energy system architecture of WU Vienna. The Campus is provided with heat and cold from a campus-wide district heating and cooling network. Both heat and cooling are generated from ground source, with a heat pump raising the temperature were necessary (Source: AEE INTEC).	93
Figure 25. Daily average ambient temperature at Skrydstrup. Created with Energy system analysis energyPRO.	98

Figure 26. Global radiation at Skrydstrup in an average year. Created with Energy system analysis energyPRO.	99
Figure 27. Duration curve for heat demand at Skrydstrup Air Base. Created with Energy system analysis energyPRO.	100
Figure 28. Duration curve for electricity demand at Skrydstrup Air Base. Created with Energy system analysis energyPRO.	100
Figure 29. Resilience in a winter situation at Skrydstrup Air Base operated electrically in island mode. Created with Energy system analysis energyPRO.	101
Figure 30. Resilience in a summer situation at Skrydstrup Air Base operated electrically in island mode. Created with Energy system analysis energyPRO.	102
Figure 31. Map of Greater Copenhagen District heating and Taarnby (Source: Taarnby Forsyning and Ramboll).	103
Figure 32. Map Taarnby Municipality including zones of District heating and pipes. Green districts. DH system established in 1985. Blue districts. Planning to shift from gas to DH in 2020-2030. District without color. One-family houses. An option to shift from gas boilers to DH or to heat pumps in 2030-2050. (Source: Taarnby Forsyning and Ramboll.)	104
Figure 33. Accumulated demand for all 132 heat consumers.	106
Figure 34. District heating pipes to a large customer (Source: Taarnby Forsyning and Ramboll).	107
Figure 35. Trench of the network from the hydraulic model. Source: Taarnby Forsyning and Ramboll.	107
Figure 36. Pressure diagram for supply of maximal heat from the heat transmission system via the heat exchanger (Source: Taarnby Forsyning and Ramboll, created with System Rornet).	108
Figure 37. Map of Greater Copenhagen District heating and Taarnby (Source: Ramboll).	112
Figure 38. Artist's rendering of the District cooling (Source: Taarnby Forsyning and Skanska).	113
Figure 39. Production of cooling.	114
Figure 40. Production of heat.	115
Figure 41. GIS illustration of the District heating and cooling (Source: Ramboll).	117
Figure 42. Map of the district cooling plant (Source: Ramboll).	118
Figure 43. District cooling plant (Source: Ramboll).	118
Figure 44. The Greater Copenhagen District Heating System (Source: Ramboll).	124
Figure 45. District heating pipe construction, with curved pipes(left) and straight pipes (right) (Source: Ramboll).	129
Figure 46. Installation of preinsulated twin pipes of supply of small buildings (Source: Ramboll).	130
Figure 47. The newest waste incinerator ARC (Source: Ramboll).	130
Figure 48. The operation flexibility and efficiency of ARC (Source: Ramboll).	131
Figure 49. The Avedøre multi-fuel CHP plant with heat storage tanks (Source: Ramboll).	132
Figure 50. District heating 25 bar transmission network from hydraulic analysis in all distribution systems (Source: Ramboll. Created with System Rornet).	133
Figure 51. Hydraulic pressure diagram for a typical critical load case for maximal transmission of all base load (Source: Ramboll, created with System Rornet).	133
Figure 52. Heat storage tanks at Avedøre CHP plant (Source: Ramboll).	134
Figure 53. Principle of operation of the heat storages tanks (Source: Ramboll).	134

Figure 54. The Greater Copenhagen District heating system.	142
Figure 55. Supply areas for district cooling clusters.	145
Figure 56. The potential for district cooling clusters.	145
Figure 57. Current district heating network.	146
Figure 58. One of the hydraulic load case for long distance transmission of heat (Source: Ramboll, created with System RORNET).	146
Figure 59. DTU Campus 2020 (Source: Strategic campus plan DTU Lyngby).	152
Figure 60. Map of the district heating system around the DTU campus (Source: DTU and Ramboll).	154
Figure 61. Heating and cooling in the tunnel system (Source: Ramboll).	156
Figure 62. DTU in 2019 with tunnel and DC installations (Source: DTU).	157
Figure 63. Long-term development including new buildings and infrastructure in the tunnel system. The infrastructure. electricity (green), district heating (red), district cooling (blue) and water for fire protection (orange). (Source: Strategic campus plan DTU Lyngby.)	158
Figure 64. Profiles for outdoor temperature (green), heat load (red), cooling load (blue).	159
Figure 65. Heat storage tank, 8.000 m <sup>3</sup> (Source: Ramboll).	160
Figure 66. Concept for heat pump; some of these coolers can be replaced by the heat pump (Source: DTU).	160
Figure 67. The new urban settlement Quaanaaq in Greenland (Source: Nukissiorfiit).	164
Figure 68. Energy balance for Qaanaaq (Source: Nukissiorfiit).	165
Figure 69. Cooling fans on the roof are now used only for emergency (Source: Nukissiorfiit).	166
Figure 70. The infrastructure in Quaanaap, Greenland, is above ground due to permafrost (Source: Nukissiorfiit).	168
Figure 71. Danfoss Nordborg Campus (Source: Danfoss).	171
Figure 72. Areal view of the campus area (Source: Danfoss).	171
Figure 73. Electricity and heating demand of Danfoss Campus has significantly decreased between 2007 and 2016 (Source: Danfoss).	172
Figure 74. Heat supply of Danfoss Campus before and after renovation.	173
Figure 75. Left: large ventilation system installed in the production halls to collect exhaust heat from machinery; right: main ventilation system (Source: Danfoss).	175
Figure 76. One of the installed 500 kW heat pumps (Source: Danfoss).	175
Figure 77. Energy system in the Danfoss Nordborg campus (Source: Danfoss and Sønderborg Forsyning).	177
Figure 78. The new urban development area Favrholt (Source: Hillerød Municipality).	181
Figure 79. Diagram of interaction between models.	184
Figure 80. District heating network from hydraulic analysis in all districts (Source: Ramboll and Hillerød Municipality).	185
Figure 81. District cooling network from hydraulic analysis to all buildings that have a cooling demand (Source: Ramboll and Hillerød Municipality).	186
Figure 82. Simple heat duration curve for the district heating in the district (sorted hours).	189
Figure 83. Simple load profile for the district cooling supply (sorted hours).	190
Figure 84. Gram district heating solar heating and heat storage pit (Source: Gram Fjernvarme).	194
Figure 85. Map of district heating zone (green) and gas boiler zone (yellow) (Source: Gram Fjernvarme).	195

Figure 86. Operation simulated with EnergyPro (Source: Ramboll).	196
Figure 87. Heat production to the network (Source: Ramboll).	196
Figure 88. Investments in heat production (Source: Ramboll).	197
Figure 89. Gram district heating system design (Source: Gram Fjernvarme).	197
Figure 90. Nymindegab Military Camp in Denmark (Source: © 2002 Skov- og Naturstyrelsen, Driftspankontoret og Hjemmevoernet).	201
Figure 91. Blåbjerg Biogas plant is situated 10 km from Nymindegab Military Camp (Source: blaabjergbiogas.dk).	201
Figure 92. Ambient temperature at Nymindegab in 2019. Created with Energy system analysis tool energyPRO.	202
Figure 93. Duration curve for heat demand at Nymindegab Military Camp. Created with Energy system analysis tool energyPRO.	203
Figure 94. A resilient energy system shown for Nymindegab Military Camp. Created with Energy system analysis tool energyPRO.	204
Figure 95. The CHP at Nymindegab Military Camp simulated in 14 days in April, covering both electricity and heating demand when operated in island mode. Created with Energy system analysis tool energyPRO.	204
Figure 96. Operating principle of the SunZEB Building. Solar thermal flow (1) passes through the building, especially through optimized window surfaces (1). In the building (2) the cooling system collects heat energy while maintaining a comfortable indoor environment. The collected thermal energy is transferred via the district cooling network (3) to a central heat pump plant (4) of the energy company, where the heat is used, in this case to the district heating network. Source: VTT.	205
Figure 97. Operating principle of the SunZEB Building. Solar thermal flow (1) passes through the building, especially through optimized window surfaces (1). In the building (2) the cooling system collects heat energy while maintaining a comfortable indoor environment. The collected thermal energy is transferred via the district cooling network (3) to a central heat pump plant (4) of the energy company, where the heat is used, in this case to the district heating network. (Source: VTT.)	206
Figure 98. Illustration of the planned area in Kalasatama, Helsinki, with the SunZEB building block indicated with an arrow (Source: City of Helsinki 2014).	207
Figure 99. SunZEB buildings are part of the urban energy platform in Helsinki operated by Helen Ltd. SunZEB together with other energy resources is connected to a combined heating and cooling plant using heat pumps between district heating and district cooling networks, converting the renewable solar energy harvested from the building.	207
Figure 100. Monthly energy balance calculated for the SunZEB building.	209
Figure 101. Aerial view of Merihaka area (Source: mySMARTLife/City of Helsinki).	215
Figure 102. Plan of Merihaka area (Source: mySMARTLife/City of Helsinki).	215
Figure 103. Best data for Merihaka (Source: City of Helsinki).	217
Figure 104. Merihaka Energy System (Source: Helen).	219
Figure 105. New heating and cooling plant located under Esplanade Park at a depth of 50metres (Source: Helen).	223
Figure 106. Underground water cooling reservoir in Esplanade Park located at a depth of 100m (Photo by Pekka Nieminen from Helen cited in an article by Walker, <a href="https://gizmodo.com/helsinki-built-an-underground-lake-to-cool-its-building-1631985837">https://gizmodo.com/helsinki-built-an-underground-lake-to-cool-its-building-1631985837</a> ).	224

Figure 107. Katri Vala facility (Source: Helen).	225
Figure 108. Katri Vala operation (Source: Helen).	225
Figure 109. Mustikkamaa planned seasonal storage (Source: <a href="https://www.helen.fi/en/news/2018/Gigantic-cavern-heat-storage-facility-to-be-implemented-in-Mustikkamaa/">https://www.helen.fi/en/news/2018/Gigantic-cavern-heat-storage-facility-to-be-implemented-in-Mustikkamaa/</a> ).	228
Figure 110. Underground facility (Source: <a href="https://www.helen.fi/en/news/2018/Construction-of-rock-cavern-heat-storage-facility-starts/">https://www.helen.fi/en/news/2018/Construction-of-rock-cavern-heat-storage-facility-starts/</a> ).	229
Figure 111. Seasonal energy storage in Kruunuvuori (Source: <a href="https://www.helen.fi/en/news/2018/Seasonal-energy-storage-facility-is-planned-for-the-Kruunuvuorenranta-rock-caverns/">https://www.helen.fi/en/news/2018/Seasonal-energy-storage-facility-is-planned-for-the-Kruunuvuorenranta-rock-caverns/</a> ).	232
Figure 112. 3D-Model of the HFT Campus buildings and overview of the neighborhood (Source: left, EnSign Reallabor HFT Stuttgart; right, google maps 2018).	234
Figure 113. Concept of energy demand and distribution and refurbishment potentials in the Campus neighborhood (Source: Handlungsleitfaden – Energieleitplan   ZNS HFT Stuttgart).	234
Figure 114. Heating Energy consumption statistics of the HFT Campus (Source: EnSign Reallabor HFT Stuttgart).	235
Figure 115. Effects of Measure Packages of HFT Campus Stuttgart (Source: EnSign Reallabor HFT Stuttgart).	237
Figure 116. Load profiles for energy system scenarios. wastewater heat pump + PV (top) CHP + wastewater heat pump + district heating + PV	
Figure 117. Energy system, scenario CHP + wastewater heat pump + district heating + PV (Source: EnSign Reallabor HFT Stuttgart).	239
Figure 118. Stakeholders in EnSign Reallabor (Source: EnSign Reallabor HFT Stuttgart).	240
Figure 119. Heat demand in “Standard” and “Pilot” refurbishment of the campus (Source: EnSign Reallabor HFT Stuttgart).	242
Figure 120. Roadmap climate-neutral HFT Campus by 2030 (Source: EnSign Reallabor HFT Stuttgart).	243
Figure 121. View on the School Campus Detmold (Source: Pape or Semke Architectural Office).	245
Figure 122. End-energy demand and consumption in 2016.	246
Figure 123. Energy production and energy consumption in 2016 (Source: Fraunhofer IBP).	247
Figure 124. Evaluation of different parameters by students and teachers (from 1 = very good to 6 = insufficient).	248
Figure 125. Rintheimer Feld (Source: Volkswohnung).	249
Figure 126. IEA Annex 51 Energy efficient communities – German case study (Source: Jank, Reinhard).	250
Figure 127. Monitoring values in February 2013 (Source: Osterhage 2016).	251
Figure 128. Guam U.S. Department of Defense (DoD) Installations and the Joint Marianas Region CEIP.	252
Figure 129. Facility energy use intensity pattern (Source: AECOM analysis).	253
Figure 130. Total and critical energy load estimation using modeling (Source: AECOM Energy Modeling).	254
Figure 131. Energy scenario planning tool process and proposed scenarios.	256
Figure 132. Energy security and readiness scorecard and criteria.	258
Figure 133. Cost performance metrics.	259

Figure 134. Decision matrix.	259
Figure 135. Mission impact index.	267
Figure 136. Site plan of the National Western Center.	273
Figure 137. Pie chart showing the components of energy demand and supply.	274
Figure 138. Energy system as planned for Denver National Western Center.	277
Figure 139. Map of the zoning districts for the Ford Site.	281
Figure 140. Chilled-water and heating water connections for the Medical District (Phase 1) at the University of Texas Austin and close up of new chilling station and thermal energy storage (TES) tank (Source: University of Texas Austin 2015).	287
Figure 141. Chilled water and heating connections for the Graduate School of Business and the Engineering, Education and Research Buildings at the University of Texas Austin. This connection is via direct connection to the Main Campus looped chilled-water and steam tunnel distribution system.	287
Figure 142. Project parameters of the University of Texas Austin divided into phases.	287
Figure 143. The heat pump chiller saves \$287,000 per year in gas savings and 17 million gallons per year in water savings. <sup>6</sup>	292
Figure 144. Energy system architecture of UT Austin Medical District.	293
Figure 145. Configuration of TES to new plant to main campus to Medical District.	296
Figure 146. Location of the UC Davis California National Primate Research Center (CNPRC).	299
Figure 147. (Left) Aerial image of CNPRC (Source: Google Maps); (Right) 2D Model of CNPRC (Source: facilitiesmap.ucdavis.edu).	299
Figure 148. Existing chillers at Primate Center (Source: Affiliated Engineers).	300
Figure 149. CNPRC heating and cooling improvements (Source: Affiliated Engineers).	300
Figure 150. Site Plan of UC Davis (Source: Affiliated Engineers).	301
Figure 151. Schematic of the biodigester process.	306
Figure 152. Energy system architecture of UC Davis.	306
Figure 153. UC Davis donated solar panels (Source: Affiliated Engineers).	307
Figure 154. UC Davis monthly cooling and heating loads (Source: Affiliated Engineers, Gene's materials).	309
Figure 155. The district energy system at the University of British Columbia includes the Campus Energy Centre and the Bioenergy Research and Demonstration Facility, a biomass cogeneration system (Source: UBC 2015).	312
Figure 156. The Academic District energy system as of December 2015 including the Campus Energy Centre (CEC) and the Bioenergy Research and Demonstration Facility (BRDF) (Source: UBC 2015).	313
Figure 157. Baseline of UBC in 2007.	314
Figure 158. System overview, UNC Academic District energy system (Source: International District Energy Association's <i>District Energy Magazine</i> . 2018 Q2). <sup>4</sup>	317
Figure 159. Inside the Bioenergy Research and Demonstration Facility (BRDF) (Source: Don Erhardt).	319
Figure 160. UBC Academic District Energy System (Source: UBC).	319
Figure 161. Energy system architecture of the Bioenergy R&D Facility.	320
Figure 162. Overview of Fort Bragg.	325



Figure 163. Energy breakdown of baseline energy and natural gas distribution (Source: SMPL/NZP, U.S. Army Corps of Engineers).	327
Figure 164. (a) Life cycle cost and (b) unserved energy of various electrical and thermal alternative architectures for typical grid outages, along with 4-day and 14-day black sky outages.	328
Figure 165. Cost optimization curve.	330
Figure 166. View on the NTNU Gløshaugen campus. The red lines are campus district heating ring with the red dots as consumer substations.	333
Figure 167. Current building stock of NTNU Gløshaugen campus.	333
Figure 168. Future development plan of NTNU Gløshaugen campus (NTNU's campus development).	334
Figure 169. Heat duration curves for B1-B4 models under corresponding renovation packages.	337
Figure 170. Development of heating energy use 2017-2050.	338
Figure 171. Energy demand with respect to cohort group.	338
Tables	
Table 1. List of case studies investigated in IEA EBC Annex 73.	31
Table 2. Case Studies have different energy needs, energy system architectures, depending on climate zone and locally available resources.	36
Table 3. Drivers for master planning processes, as documented in case studies, sorted by country.	41
Table 4. Categories of financing / business models in the best practice cases.	44
Table 5. Framework conditions to be considered regarding later planning and later phases.	55
Table 6. Storage solutions featured in case studies.	56
Table 7. Generation types featured in case studies. The list is not complete, only some exemplary case studies are listed for each generation type.	56
Table 8. Software and tools reported in case studies.	59
Table 9. General quantitative information on University Campus in Townsville (all measured data).	68
Table 10. Additional information on University Campus in Townsville.	69
Table 11. Quantitative Information on University Campus in Cairns case.	74
Table 12. Additional Information on case University Campus in Cairns, Australia.	74
Table 13. Quantitative Information on case of University campus in Innsbruck.	81
Table 14. Additional Information on case of University Campus Technik in Innsbruck, Austria.	82
Table 15. Quantitative Information on Case of WU Campus.	91
Table 16. Additional information on WU Campus Case.	92
Table 17. Quantitative Information on Taarnby District Heating: Investment key figures and heat losses calculated.	105
Table 18. Additional Information on Taarnby District Heating.	106
Table 19. Additional Information on Taarnby district cooling.	116
Table 20. Additional Information of the district heating network construction.	144
Table 21. Additional Information on DTU case.	159
Table 22. Additional Information on district Quaanaap (mostly measured in 2010).	167
Table 23. General quantitative Information on energy supply of Danfoss Campus.	173
Table 24. Additional Information on Energy Supply of Danfoss Campus.	174
Table 25. Additional information of energy planning in urban development Favrhholm.	184

Table 26. No of heat consumers, floor area, and heat demand by district.	184
Table 27. Summary of district heating investments by district.	185
Table 28. Number of cooling consumers, floor area, and cooling demand and capacity demand by district.	186
Table 29. District cooling network.	187
Table 30. Technical data for network and production capacity.	188
Table 31. Total costs of individual scenario and combined scenario.	188
Table 32. Profitability for the district heating part.	188
Table 33. Profitability for the district cooling part.	189
Table 34. Profitability of the whole project for combined heating and cooling.	189
Table 35. Additional Information on Supply System for Favrholt, Denmark.	196
Table 36. Estimated heat demand in 2016 at Nymindesgab Military Camp.	202
Table 37. Information table on SunZEB project.	209
Table 38. Quantitative Information of the heat pump project in Esplanade Park.	223
Table 39. Quantitative information on Katri Vala heat pump in Helsinki, Finland.	226
Table 40. Quantitative Information on Mustikkamaa.	229
Table 41. Quantitative Information on heat storage at Kruunuvuori, Finland.	231
Table 42. List of measures for HFT Campus Stuttgart	236
Table 43. Packages of measures for HFT Campus in Stuttgart.	237
Table 44. Additional Information on HFT Campus modernization.	237
Table 45. Investment costs for modernization excluding + 20% for planning & + 19% taxes.	238
Table 46. Utility demand.	263
Table 47. Rate schedule.	263
Table 48. Risk assessment approaches and goals for Fort Bliss.	265
Table 49. Example installation status report.	268
Table 50. General quantitative information about Generation, Storage, and Consumption of Energy in Denver National Western Center. "After" energy demand and energy yield estimates are taken from the June 28, 2018 "NWC Campus Energy Concept RFP Supporting Information for Procurement Only," which is not publicly available. "Before" estimates are from AECOM's sewer heat recovery screening analysis in the "Delgany Interceptor and South Platte River Study Alternatives Analysis" report, June 28, 2017.	274
Table 51. Additional information on building mix and energy supply concept.	275
Table 52. Quantitative Information on Ford Site.	283
Table 53. Total output emission rates and non-baseload output emission rates for ERCOT.	290
Table 54. Parameters according to building type, heating, cooling and electricity.	290
Table 55. General Information on UT Austin campus.	291
Table 56. Quantitative information on energy distribution, storage and demand.	291
Table 57. Additional Information on energy system of UT Austin.	292
Table 58. CO <sub>2</sub> Emission ranges, total and for non-baseload output.	302
Table 59. General quantitative information on energy supply at UC Davis.	303
Table 60. Details on Energy Supply System of UC Davis, Baseline, Basecase and Preferred Scenario. All heating and cooling demands include distribution losses. Of the thermal	

energy demand – heating, the total 21,500 MMBtu/yr, is comprised of 3,500 MMBtu/yr of solar thermal energy demand and 18,000 MMBtu/yr of hot water boiler energy demand.	304
Table 61. Project additional information.	304
Table 62. Thermal energy supply technologies.	305
Table 63. Hot water production.	305
Table 64. Maximum loads and critical loads.	310
Table 65. Quantitative placement: Floor area and users.	315
Table 66. Quantitative data on energy supply system.	316
Table 67. Additional information on UBC.	316
Table 68. EEMs evaluated for the facility groups.	329
Table 69. Cohort groups of buildings based on construction years.	334
Table 70. Information table on NTNU Gløshaugen campus.	335
Table 71. Establishment of EEMs.	335
Table 72. Scenario specification.	336
Table 73. Specific heating energy use for B1-B4 models with introduced EEMs.	337

## Executive Summary

Experience without theory is blind,  
but theory without experience is mere intellectual play.

Immanuel Kant

THIS PAGE INTENTIONALLY LEFT BLANK

## CHAPTER 1. INTRODUCTION

Wherever humans have lived, they had to cope with everyday challenges and rare disruptive events that threatened their lives. Buildings, energy systems, all infrastructure has the scope to protect and comfort us. Throughout history, the challenge has always been to best adapt to local circumstances by handling challenges and using by potentials for constructive change, or to simply run away and look for a better place to live.

In modern times, we have advanced technologies is at our disposal to help us cope with the environment. Also, the challenges we have to face have evolved; weather extremes currently threaten our complex and often vulnerable infrastructure. Moreover, in many countries of the world, infrastructure built since industrialization has not kept pace with needs for high efficiency or is even deteriorating, and must be modernized to improve efficiency, resiliency, and to incorporate the use of more renewable energy.

So, what are the barriers to applying our knowledge to create a truly integrated, efficient, and resilient energy infrastructure? One big part is habits. We know that people are creatures of habit; we like to go on doing what we have always done. Moreover, we have created structures, both in the physical infrastructure and in governing legislation that allow for certain solutions and prevent others. Another barrier is cost; innovative or special solutions usually require a higher investment cost than do traditional technologies. If our actions are guided by the simple desire to maximize profits in the short term, then there will be little room for better solutions that over the life cycle might be more cost-effective. Another point is complexity; integrated systems require cooperation and communication. At the outset, it will take longer to involve all stakeholders in a complex, integrated solution even though it will create a better solution in the long term. In fact, better solutions often require more cooperation and communication, and higher first investment. Up to now, it seems this additional investment in resources and commitment is not being made in most cases. If we want to continuously adapt to the changing environment, we need to evolve our ways of planning and building.

It would be instructive in this effort to look to those places where people have handled their local challenges and demands in an exemplary way. They have used experience and know-how gathered over a long time, learned from trial and error, and continued to invest the needed time, effort, and resources to build better, more efficient, more energy resilient communities. They considered possible threats and local potentials, and cooperated in large teams to achieve truly admirable results. We can learn from these cases by exploring the methods that were applied and by considering what might be done to further improve future systems.

Part of the Annex 73 project 'Towards Net Zero Energy Resilient Public Communities' studied cases of community energy master planning. The goal was to investigate how energy master planning for entire communities is performed, and to find out how it can be improved. In each participating country, cases of community master planning were chosen, studied, and analyzed. Case studies included military camps, universities, research institutes, hospitals, small communities, towns, and large cities. In most of these cases, buildings and systems (including critical infrastructure like data servers or life sustaining systems) are owned by public entities. Therefore, resilience and reliability play a strong role.

The impact of local climate conditions is a crucial influence on the choice of energy supply systems. The described case studies are located in different areas of the world, ranging from tropical regions in Australia to icy Greenland. The following report is structured as follows:

- **Chapter 2** gives an overview of all case studies.
- **Chapter 3** categorizes case studies according to different attributes like energy use, climate conditions, etc.
- **Chapter 4** summarizes lessons learned from the case studies.
- **Chapter 5** includes lessons learned regarding master planning processes, summarizes the current trends in energy master planning and projects the future of community energy master planning processes.
- **Chapter 6** offers an in-depth description of the case studies.
- **Chapter 7** summarizes the methodologies used in the Annex 73 case studies.



## CHAPTER 2. CASE STUDY OVERVIEW

Several different kinds of cases were studied to better explore the complexity of the topic, and to enhance the transfer of knowledge and technologies.

**Type 1** include **energy supply systems** in large cities, towns, and villages. In such locations, buildings are seen as “consumers” that are connected to these supply systems. In energy planning, building-level energy production facilities are compared with the energy system energy production. Also, special spare and backup capacity can be installed to serve critical demand in some buildings.

**Type 2** represent **campus-like structures** like university campuses, military installations, and research centers, where groups of buildings can be analyzed together with their energy supply systems.

**Type 3** case studies **focus on single components** that may have been added to enhance an energy supply system. Most of these cases, which are from Finland, concern themselves with the introduction of heat recovery by heat pump or the introduction of heat storage systems into traditional energy supply systems.

Case studies also differ by their state of development. In some cases, existing energy supply systems were investigated in hindsight by analyzing how it was possible to plan and implement these systems (some of the Danish cases), to draw conclusions on their long-term performance and operation. Other cases studies focus on measures that are only now coming to realization. In most such cases, only the planning process is in focus of the case study, although some cases may provide potentially limited feedback from the actual realization and operation.

Table 1 lists the case studies, including information on the location (country, location) and the type of use (Type). The symbols in the last column represent the main characteristics of the case study. Figure 1 shows the legend for these symbols.





























	District Cooling		Geothermal or Groundwater Energy		Heat Pump
	District Heating		Heat / Cool water Storage		Green Roofs
	Solar Energy		Building Focus or Critical Infrastructure		Use of Waste Heat / Renewable Sources

Figure 1. Symbols for main characteristics to be used to highlight focus of case studies.







Table 1. List of case studies investigated in IEA EBC Annex 73.

Case No.	Country	Location	Type	Main Characteristics
----------	---------	----------	------	----------------------

Case No.	Country	Location	Type	Main Characteristics
6.1	Australia	Townsville	Campus University	  district cooling, cold storage
6.2	Australia	Cairns	Campus University	  district cooling, cold storage
6.3	Austria	Innsbruck	Campus University	  building efficiency, ambient cold
6.4	Austria	Vienna	Campus University	    district cooling/heating, heat pump, groundwater thermal storage
6.5	Denmark	Skrydstrup	Military Air Base	   biogas CHP, district heat, thermal storage
6.6	Denmark	Taarby	District heating in a town including a large airport campus	  low carbon heat e.g. waste-fueled CHP, district heating
6.7	Denmark	Taarby	District cooling in an urban development area	 district cooling
6.8	Denmark	Greater Copenhagen	District heat in a large city including 20 communities and many campuses	 district heating
6.9	Denmark	Vestfor-brænding	District heating in five suburbs	  district heating, waste-fueled CHP

Case No.	Country	Location	Type	Main Characteristics
6.10	Denmark	DTU Close to Kopenhagen	District heating and cooling in a University campus	 district heating and cooling
6.11	Denmark, Greenland	Quaanaap	District heating in a small town	 district heating from CHP
6.12	Denmark	Danfoss Campus	Campus Company Campus	 district heating, heat pump, solar energy, thermal storage
6.13	Denmark	Favrholm	District heating and cooling in urban development	 district cooling/heating, heat pump, thermal storage
6.14	Denmark	Gram	District heating in a small town	 thermal storage, district heating
6.15	Denmark	Nymindgab	Military Camp	 Biogas CHP, district heating, storage (biogas, thermal)
6.16	Finland	Helsinki Kalasatama	Singe Components sunZEB Building for District	 building focus, district heating/cooling, solar energy
6.17	Finland	Merihaka	Campus District Refurbishment	 building efficiency

Case No.	Country	Location	Type	Main Characteristics
6.18	Finland	Helsinki Esplanadi Park	Single Component Heat pump for district heat	 heat pump for district heating/cooling
6.19	Finland	Helsinki Katri Vala	Single Component Heat pump for district	 heat pump for district heating/cooling
6.20	Finland	Helsinki Mustik-kamaan	Single Component Heat storage for district	 thermal storage, district heating
6.21	Finland	Helsinki Kruunuvuori	Single Component Seasonal heat storage for district	 seasonal thermal storage for district heating
6.22	Germany	Stuttgart	Campus University	 solar energy, building efficiency
6.23	Germany	Detmold	Campus Education Campus	 solar energy, building efficiency
6.24	Germany	Karlsruhe Rintheim	Energy Supply System District	 district energy system
6.25	USA	Guam	Campus Military Town	 renewable sources, critical infrastructure
6.26	USA	Texas Fort Bliss	Campus Military Town	 renewable sources, critical infrastructure

Case No.	Country	Location	Type	Main Characteristics
6.27	USA	Denver National Western Center	Campus	 <p>heat pump, district heating, renewable sources</p>
6.28	USA	St. Paul	Campus New District	 <p>solar energy, thermal storage</p>
6.29	USA	Austin	Campus University	 <p>district energy system, critical infrastructure</p>
6.30	USA	Davis	Campus Research Center	 <p>district energy system, critical infrastructure, solar thermal</p>
6.31	Canada	Vancouver	Campus University	 <p>district energy system, critical infrastructure</p>
6.32	USA	Fort Bragg	Campus Military Town	 <p>critical infrastructure, heat pump, thermal storage</p>
6.33	Norway	Trondheim	Campus University	 <p>critical infrastructure, district heating, heat pump, solar and renewable sources</p>

## CHAPTER 3. CATEGORIZATION OF CASE STUDIES

To allow for a faster and more efficient analysis, case studies were categorized according to different attributes. Categories include type of case, climate, energy sources, storage methods, redundancy, and other characteristics. Categorization was done by various teams and, depending on the focus of the study, led to different results, which are summarized in the tables in this chapter and also in Appendix E of the Annex 73 EMP Guidebook, which describes energy system architectures. This chapter also provides a short overview and introduction to the case studies using some information drawn from the aforementioned categorization.

The **'Type of Case Study'** is distinguished by Campus and District systems. Case studies on universities, military installations, and other sites where buildings and their energy systems were studied in combination are considered 'Campus' locations. A 'District' system refers to those case studies that involve district heat and/or cooling networks, and often even more specifically, single measures or components installed to enhance these networks.

### 3.1 Energy System and Climate

Each case study investigated the use of local resources and energy storage. Table 2 lists the type of energy needed in the area of interest, as distinguished by cold, heat, and power; and by energy sources used, storage type, and climate. As the data in Table 2 indicate, thermal storage is common. Heat storage has been realized in almost all cases involving district heating and cooling systems. Especially when volatile resources are used, thermal energy storage becomes a requirement. Oftentimes, power storage takes the form of diesel power units. Although it is locally available in many cases, particularly to supplement needs of the critical infrastructure, the data in Table 2 do not consider diesel power backup.

**Table 2. Case Studies have different energy needs, energy system architectures, depending on climate zone and locally available resources.**

Study Name	Main Energy Needs	Energy Sources	Storage	System Architecture	Climate Zone (According to IECC / ASHRAE)
James Cook University, Townsville, Queensland	power, cooling	power grid	thermal	Type 1.3.2	Tropical savanna
James Cook University, Cairns Queensland	power, cooling	power grid	thermal	Type 1.3.2	Tropical monsoon
University of Innsbruck, Technology Campus	power, heating, cooling	power grid, heat from gas, ground water		Type 1.3.4	humid continental
Vienna University of Economics and Business, Campus	power, heating, cooling	power grid, ground water + heat pump	ground water	Type 1.3.4	humid continental
Air Base Skrydstrup, Denmark	power, heating,	combined district heat and power (CHP), biogas	thermal and power	Type 1.2.1	temperate
Taarnby district heating	Heating	waste heat, CHP, gas, heat pump	thermal	Type 3.1.1	temperate
Taarnby district cooling	Cooling	ambient, waste, heat pump	thermal	Type 2.3.4.1	temperate

Study Name	Main Energy Needs	Energy Sources	Storage	System Architecture	Climate Zone (According to IECC / ASHRAE)
Greater Copenhagen District heating	Heating	waste heat, CHP, gas, heat pump	thermal	Type 1.3.4	temperate
Vestforbrænding District Heating	Heating	waste heat, CHP, gas, heat pump	thermal	-	temperate
Danish Technical University	power, heating	power grid, waste heat, CHP, gas, heat pump	thermal	Type 2.3.4.3	temperate
Quaanaap district heating	power, heating	CHP		Type 4.3.1	Arctic
Favrholm Urban development district	Heating	waste heat, CHP, gas, heat pump	thermal	Type 3.3.4	temperate
Denmark, Danfoss campus	Power, heating, process heat	waste heat, CHP, heat pumps, power grid	Thermal	Type 1.3.1	temperate
Village of Gram	Heating	waste heat, CHP, gas, heat pump	large-scale thermal	Type 2.3.1.1	temperate
SunZEB Kalasatama	Heating, cooling	Heat recovery, heat pump	Large-scale thermal	Type 2.3.4.1	humid continental
Horizon 2020 Lighthouse project MySMARTLife actions in Merihaka retrofitting area				Type 3.1.2	humid continental
Esplanadi Park	heating, cooling	waste heat, heat pump	large-scale thermal	Type 1.3.4	humid continental
Katri Vala	heating, cooling	waste heat, heat pump	large-scale thermal	Type 1.3.4	humid continental
Mustik-kamaan	heating, power			Type 1.3.4	humid continental
Kruunuvuori				Type 1.3.4	humid continental
HFT Stuttgart	power, heating, cooling, solar	power grid, district heat		Type 1.3.1	humid continental
Detmold	power, heating	power grid, district heat		Type 1.3.1	humid continental
Karlsruhe Rintheim	power, heating	power grid, district heat		Type 1.3.1	humid continental
Guam	power, cooling	power grid		Type 1.1.3.1	tropical rainforest
Fort Bliss	power, heating, cooling	power grid		Type 1.1.3.1	cold desert to hot desert
National Western Center in Denver, CO	power, heating, cooling	Power grid, waste heat from sewage and heat pumps		Type 1.2.3	semi-arid continental
St. Paul Ford Site in St. Paul, MN	power, heating, cooling		thermal	Type 1.3.4	Continental
UT Austin	power, heating, cooling	power grid, emergency generators	thermal	Type 2.3.4	humid subtropical

Study Name	Main Energy Needs	Energy Sources	Storage	System Architecture	Climate Zone (According to IECC / ASHRAE)
University of California (UC) Davis	power, heating, cooling	power grid, solar thermal	thermal	Type 1.2.4	Mediterranean
University of British Columbia	power, heating, cooling	power grid, renewables	thermal	Type 1.3.1	Oceanic
Fort Bragg	power, heating, cooling			Type 1.1.3.1	Humid
NTNU Gløshaugen campus	power, heating	power grid, solar photovoltaic (PV), district heating, waste heat- heat pump, biogas CHP		Type 1.3.1	Oceanic and humid continental

To allow for a more efficient energy system design, the system architectures of energy systems were analyzed and categorized. The categories are identified by a combination of numbers, see 5th column of Table 2 (e.g., Type 1.1.3.1). The method behind this numbering is described in detail in Chapter 8 of the Annex 73 **Guidebook**. This methodology also allows for a standardized graphical representation of the energy system architecture. In some case studies, the energy system has been mapped following this methodology. The results are shown in Figures 2 to 5.

In the graphical representation, components of the energy system like energy source, storage and consumer are **assigned to different levels**, ranging from upstream network level to the building cluster or building level. In this way, one can easily see how centralized the energy system is, and which levels energy sources, storage and conversion are assigned to.

Figure 2 shows the energy system architecture of Qanaaq in Greenland. Both power and heating are created locally from oil CHP. Additional heat is provided by oil and waste boilers. Buildings include mission critical consumers.

### Qanaaq (Greenland) No. 2.3.1.3

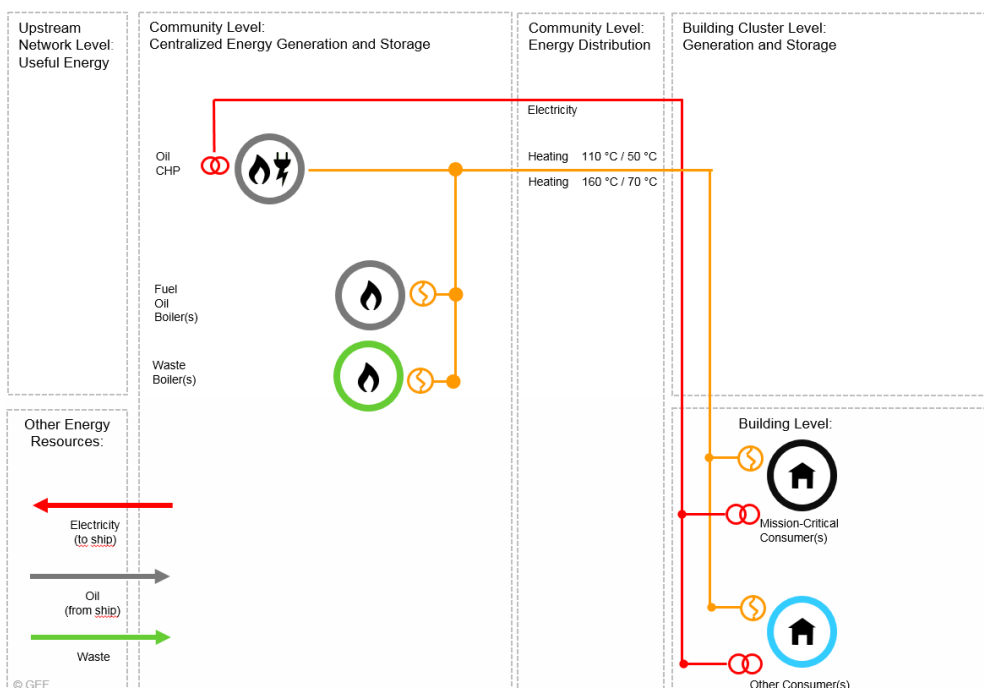



**Figure 2. Energy system architecture for case study on Quanaaq, Greenland.**

**Taarnby District, Copenhagen (DK) No. 2.3.4.1**

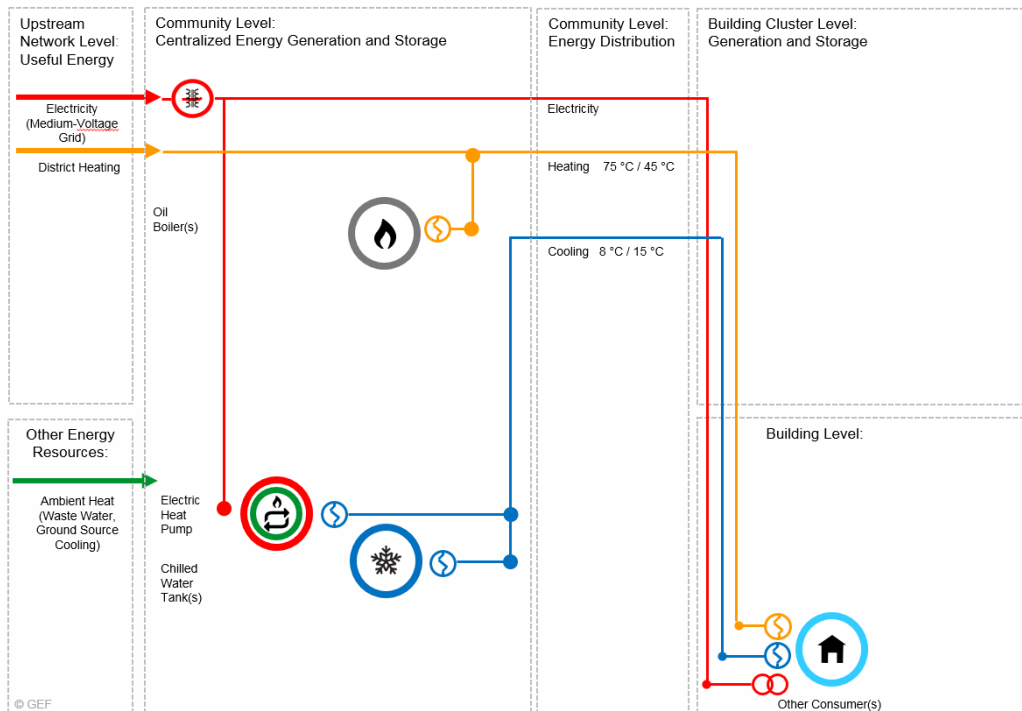

**Figure 3. Energy system architecture for case study on district cooling in Taarnby, Denmark.**

In Figure 3, a graphical representation of the heat and electricity supply of the Taarnby District in Copenhagen is shown. Both electricity and district heating are provided from the network level. On the community level, an additional oil boiler can generate backup heat. Also on the community level, ambient heat is used by an electric heat pump to generate both cold and heat. The temperature levels of supply and return are added to the distribution lines.

Figure 4 shows the energy system architecture of the University of California Davis. Electric energy is provided from the network. In addition, biogas and natural gas are available. These are used in addition to solar thermal elements to generate heating.

A heat storage at the community level can be used for peak shaving and increases coverage by solar thermal. Also at the community level, electric chillers create a cold supply. On the building level, there are emergency generators for mission-critical consumers.

The last example is that of the university Campus Technik in Innsbruck (Austria, see Figure 5) Electricity is provided by the upstream network, while heat is created locally from natural gas. There are emergency power supply units on the building cluster level, which serve mission-critical consumers. Cooling is provided on the building level by electric chillers, and is secured by cold storage in the ground water.

# University of California Davis CNPRC No. 2.3.4.4

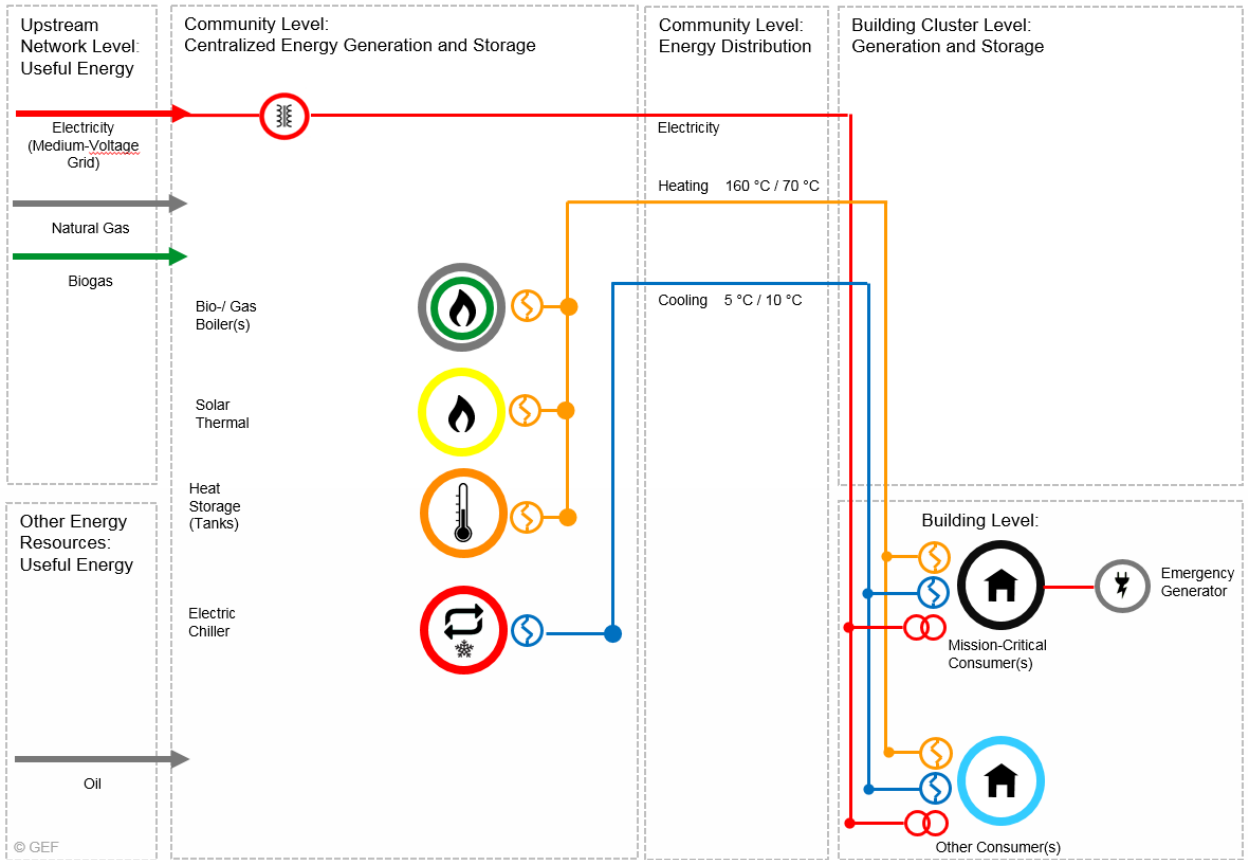

Figure 4. Energy system architecture for case study on UC Davis, USA.

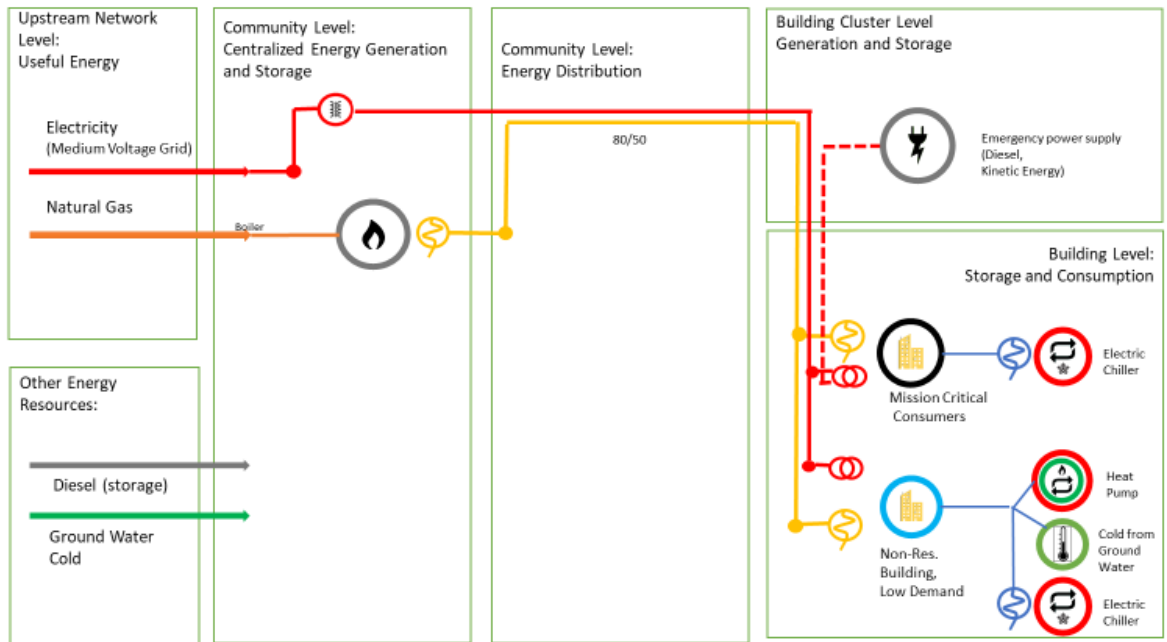

Figure 5. Energy system architecture of the University Campus Technik in Innsbruck (AUT). The system is of type 1.3.4.

With a special focus on technologies, energy systems of some case studies have been categorized according to a series of characteristics that have been developed together with

the classification of energy system architectures. Figure 6 provides insight on the result of this work. The full table can be found in the Appendix E of the Annex 73 Guidebook.

System design and case number	Classification System					Case		District heating				District cooling		Renewable energy			CHP				
	Type of example	Spatial location	Buildings to be supplied from the outside with ...	No. of example	Indexation	Case number (Task B)	Energy system example (Task C)	Steam system	District heating system (180/70)	District heating system (110/80/50)	District heating system (20/60/40)	High temperature cooling 10/15	District cooling system (5/10)	Solar Heating	Geothermal	Solar PV	Wind turbine	Oil CHP	Gas CHP	Biomass CHP	Waste CHP
1	Best practice examples	At community level	Power + heating	Example 1	2.3.1.1	Quanaaq, Greenland	---	---	---	X	---	---	---	---	---	---	X	---	---	---	---
2	Best practice examples	At community level	Power + heating + cooling	Example 1	2.3.4.1	Taarby district heating	---	---	---	X	---	---	---	---	---	---	---	---	X	X	---
3	Best practice examples	At community level	Power + heating + cooling	Example 2	2.3.4.2	Taarby district cooling	---	---	---	X	X	X	---	---	---	---	---	X	X	X	---
4	Best practice examples	Combination	Power + heating + cooling	Example 2	2.4.4.2	Greater Copenhagen district heating	---	---	---	X	X	X	X	---	---	---	---	X	X	X	---

Figure 6. Detail of classification table from technology database.

### 3.2 Drivers

The case studies were examined to identify the driving forces for change. Common drivers include campus growth, growing demand of supply, economic reasons (like the oil crisis of the early 70s), costs for supply, and taxes and targets that have been fixed by governments. Table 3 provides relevant case study details.

Table 3. Drivers for master planning processes, as documented in case studies, sorted by country.

Country	Drivers
Australia	<ul style="list-style-type: none"> <li>campus growth</li> <li>system load</li> </ul>
Austria	<ul style="list-style-type: none"> <li>building age</li> <li>indoor conditions</li> <li>demonstration</li> <li>operation costs</li> </ul>
Canada	<ul style="list-style-type: none"> <li>living lab</li> <li>aging infrastructure</li> <li>carbon tax</li> </ul>
Denmark	<ul style="list-style-type: none"> <li>reduce cost for the society including cost of CO<sub>2</sub> and harmful emissions</li> <li>city growth, cost efficiency and lower prices for the consumers</li> <li>comfort, lower costs, flexibility</li> <li>costs, resilience, efficiency, living lab, cooling</li> <li>growing cooling demand, symbiosis between district cooling and district heating</li> <li>more available space in buildings and no environmental problems with cooling</li> <li>avoid energy production facilities in buildings and in local neighborhood</li> </ul>
Finland	<ul style="list-style-type: none"> <li>attractive apartment buildings</li> <li>climate change</li> <li>climate change mitigation</li> <li>regulation</li> <li>reduce greenhouse gas (GHG) emissions</li> <li>find alternative energy sources for district heating and cooling</li> </ul>

Country	Drivers
	<ul style="list-style-type: none"> <li>initial drivers often vary and may arise from individual needs</li> </ul>
Germany	<ul style="list-style-type: none"> <li>aging systems</li> <li>low comfort</li> <li>high consumption and costs</li> <li>new quarter</li> </ul>
USA	<ul style="list-style-type: none"> <li>aging systems</li> <li>demonstration</li> <li>campus growth</li> <li>costs</li> <li>GHG emissions</li> <li>new district</li> <li>regulation</li> <li>regulation, installation growth</li> </ul>
Norway	<ul style="list-style-type: none"> <li>campus growth, different building age cohorts</li> <li>high energy consumption (both electricity and heating)</li> <li>goal of achieving a Zero Energy / Emission Neighborhood in 2050</li> <li>GHG reduction</li> </ul>

The full categorization table is added to this report as attachment. It contains objectives, measures for efficiency, measures for resilience, climate change impacts and other useful information. Due to its size, it cannot be included into the main report, and is found at Universal Resource Locator (URL): <https://nx3557.your-storageshare.de/s/cbtk8Erjiawdd7r>.

### 3.3 Financing and Business Models

The case studies illustrate a number of typical business models characterized by:

- Identified solutions are typically lower in life cycle costs than existing solutions (base line) or alternatives.
- Thus, investment can be paid off by the tenant over the life cycle.
- Projects are often owned by public entities like energy providers or communities. These have access to market credits at low interest rates and often even provide a loan guarantee. In some cases, money from government bonds has been used instead of capital market loans.
- In some cases, public funding was used to support part of the project like solar energy production or to support studies on life cycle costs.
- When setting up new district energy systems for cooling, investments are at least partly covered by connection fees and fixed annual payments of future customers.
- Banks and financing institutes are often involved in the planning phase to offer competitive financing

The case studies also demonstrate different variants and sometimes innovative business models (Table 4) in the following contexts:

- In Denmark, most energy systems are owned by communities. This has shown to be most profitable for the local community. To benefit from market forces, some services are outsourced to private companies.
- It was a political decision to allow communities to have their own companies for gas, heat transmission, and distribution. These companies operate completely independently from municipal budgets, all costs are covered by tariffs, and the municipality can guarantee loans.

- Some cases from Denmark deal with distributed ownership, for example, if district heating grids are combined to increase resilience and optimize reaction to energy costs. The District Heat Act specifies that no profit can be made in heat supply so the approach is to cover costs of each player.
- District cooling is not bound by such regulations, but district cooling must compete with consumer individual solutions. Moreover, district cooling is bound to district heating since the system depends on the co-creation of heat and cold.
- In case of the Danish Danfoss, a private company modernized its infrastructure. The payback period for investments was 3.1 years, which was below expectation. The project was supported by 25% public funding.
- In Gram, Denmark, district heating depends on contractors for the generation and storage of heat.
- Another way of financing is sponsorship, as realized at the Vienna University of Economics and Business (German “Wirtschaftsuniversität Wien” or “WU”) (Austria), where specific institutes of the university are sponsored by a private company (which provide funds in exchanges for access to research results and publicity).
- WU Vienna (Austria) also provides an example of shared responsibility between a university and a public building company by creating a shared venture that plans, owns, and operates the campus.
- The case study on Merihaka, Finland focuses on an existing district where energy efficiency measures needed to be established. Here, a lack of suitable financing methods for the private apartment owners was identified and addressed by local energy supplies.
- The case study at Stuttgart University considers different options for financing like intracting, contracting, green bonds, and crown-financing before settling on public financing.
- The military settlement in Guam had a need to increase resilience. Analysis of measures showed that demand reduction and energy efficiency measures could be used to finance resilience measures. Thus, measure bundles that were attractive for third-party investment (public utility investment and private energy performance service contracts) were created. (Contracting?)
- The case study at the U.S. Army installation Fort Bliss shows that, depending on the goal or type of energy measures and the ownership of the energy system (privatized or public), the approach varies between using existing Utility Privatization Contracts, Operation and Maintenance budgets, military construction, third-party financing like Utility Energy-Saving Contracts. Most U.S. Army projects will supposedly be funded using Operation and Maintenance budgets.
- At the Denver National Western Center, the city, as building owner, had no funds to invest and thus allowed a private company to make investments in the energy systems, to be repaid through utility bills. (private public partnership, contracting)
- U.S. university campus refurbishment projects are often privately owned by the university itself, including the energy systems. Investments can be justified by future savings and are obtained at reasonable cost on the capital markets.

**Table 4. Categories of financing / business models in the best practice cases.**

<b>Who?</b>	<b>Financing source?</b>	<b>How?</b>	<b>Technical measures?</b>	<b>Where ?</b>
<b>Public / municipality</b>	Financed on capital market, guaranteed by municipality	Asked for by law, reliable grids	Use of renewables, diverse generation plants, switching between energy sources according	Most Danish cases
<b>Public / University</b>	Public funds	By efficiency, demand reduction and storage	Efficiency, avoided costs of installing higher capacity	Australia
<b>Private</b>	Financed on capital market, proprietary capital and, 25% public funds	Reliable grids, local generation	Efficiency	Denmark , Danfoss
<b>Public</b>	Financed on capital market and by national bonds	Uninterruptible Power Supply (UPS) in case of necessity, reliable grids, local generation	Use of renewables, efficiency	Austria
<b>Public Utility company</b>	Loans from financial institutions (capital market) and proprietary capital	By redundant energy generation	Use of previously wasted heat by storage and heat pump, cogeneration of cold, heat	Finland
<b>Public, department of defence</b>	Financed by Operation and Maintenance Budgets	Financed by bundling these measures to energy efficiency cost reducing ones	Energy efficiency	USA
<b>Public / municipality</b>	Energy system is created, owned and operated by a private company that sells the energy.		Use of waste heat, energy efficiency, renewable power production	USA
<b>Private, University</b>	Financed on capital market, partly supported by public funds for renewable energy	Redundant supply, smart grid	Efficiency, cost-effective generation of own power and heat, use alternative sources like of landfill gas	USA
<b>Private, University</b>	Financed on capital market, partly supported by public funds for renewable energy	Redundant supply, smart grid	Efficiency, cost-effective generation of own power and heat, use alternative sources like of landfill gas	USA

## CHAPTER 4. LESSONS LEARNED FROM CASE STUDIES

Project owners in the case studies were asked to identify major success factors, bottlenecks, and lessons learned. This chapter summarizes the answers to these questions.

### 4.1 Success factors

What success factors were highlighted in the case studies? This chapter groups success factors by four main topics: goals, cooperation, integration, and analysis.

It is critical to consider project **goals** during the planning stage. The experience of the Danish energy system planning institute Ramboll, which is responsible for most of the Danish case studies, shows that project goals differ according to stakeholder role:

- For a campus owner, the goal will typically be to minimize the total life cycle cost of providing a sufficient indoor climate and resilient energy supply, based on energy prices at the campus gate, including taxes and subsidies.
- For local communities, the planning authority typically minimizes the total life cycle cost of providing a sufficiently low carbon and resilient energy supply to all buildings and campuses in the community based on energy prices at the city gate, including taxes and subsidies.
- For the national community, the planning authority will typically minimize the total life cycle cost of providing a sufficient low carbon and resilient energy supply to all buildings and campuses in the country, based on import/export energy prices excluding taxes and subsidies.

Another factor often mentioned in the case studies is **cooperation**. To find the best solution for a community, it is important that all major stakeholders cooperate and give access to all necessary information to the planning authority, and that they later become part of the solution according to their role. Before implementation, it is important to agree on how to share the benefit of the best solution and how to implement it.

The studied cases indicated that the **integration** of local potentials and possible reactions to rare events is of great importance. In Denmark, planning teams draw on the rich experience of at least 4 decades of planning and implementing integrated energy systems. When systems are to change, experts consider planning one or two levels above the project itself, and improving projects by identifying smart sector integration:

- To plan installations in a building, it is necessary to consider planning at the campus and city level.
- To plan installations in a campus, it is necessary to consider planning at the city level
- To plan at the city level, it is necessary to consider planning at the national level

**Calculation and analysis** have also been reported as important methods to help stakeholder achieve good results with the limited resources.

Chart 1 shows the major success factors. Some of them have appeared in many case studies, or are general conclusions from the case studies. Others refer to one specific case study, which is then mentioned for cross-reference.

#### Goals & Framework

- *Define clear goals, targets and priorities from the start.*
- *Have a framework for your planning and for analyzing and evaluating proposed alternative options*
- *Tying the project to the strategic goals (carbon neutrality and others) of the city, energy company and real estate developers (case study on SunZEB, Finland)*
- *The energy infrastructure in the area, especially the connection to the large central heat pump, was a key enabler (SunZEB, Finland)*

#### Cooperation

- *Identify, involve, engage and manage all stakeholders (as described in case study on Ford Site, US)*
- *Gather support and ensure engagement from main stakeholders and drivers right from the start*
- *Have a clear mandate; define clear roles & clear responsibilities, find suitable organizational structure (case study on WU Vienna, Austria)*
  
- *Gather a strong and well-rounded project team that encompasses major stakeholders (UC Davis, US)*
- *Establish good, frequent communication and team spirit as these projects last (usually) for several years (case study on WU Vienna, Austria and HFT Stuttgart, Germany)*
  
- *Trust in people, technology and concepts*
- *If necessary, build up trust in smaller pre-projects and demonstrations*
- *Inclusiveness, shared decision making boosting local participation, knowledge transfer, networks of best practice solutions and their providers, match-making and district level learnings for early planning (Merihaka, Finland)*

#### Integration

- *Long-term thinking in planning and investments is vital*
- *Bear in mind potential future development (like population growth, additional need for capacity, climate change)*
- *Think holistically, do not treat matters as stand-alone, always try to address them as part of bigger whole (as shown in Danish case studies)*
- *Look for integration of / in existing energy systems*

#### Analysis

- *Adjust your level of detail to the progress of the project*
- *Have a clear business case with cost-efficiency and cost-effectiveness: Based on life-cycle costs and on long-term planning*
- *Weigh in reduced operation and maintenance costs and environmental costs like very good costs (Danish Case Studies, Ramboll)*
- *Include and monetize also aspects such as resilience, sustainability, comfort, quality of living / working*
  
- *Show and highlight verified costs estimates including investment, operation and maintenance and delivered energy and cost savings*

#### Costs and Financing

- *If a sustainable solution has similar life cycle costs as the standard solution, this can be very helpful. In case of SunZEB (Finland) the “affordable solution with a similar lifetime cost compared to the conventional approach” was chosen.*

**Chart 1. Major success factors that have been pointed out in the case studies.**



## 4.2 Bottlenecks

Bottlenecks slow a project down and in the worst case may even stop and impede it. Bottlenecks are the main challenges. Experience from case studies shows that there are some typical situations in the realization of resilient low energy neighborhoods that act as bottlenecks.

Lack of information or data in the early process phase has been reported in several cases. Many decisions need to be made early in the process. It is not possible to find good solutions if input is missing or denied in this process phase.

On the other hand, motivation helps to overcome bottlenecks. When one encounters challenging situations, it is of uttermost importance that there be a strong driver or need for the proposed solution. A clear layout of drivers and need for the chosen concept or idea can help to push the solution to successful completion. Chart 2 shows bottlenecks (BN) and means to overcome (ME) them that were reported in the case studies.

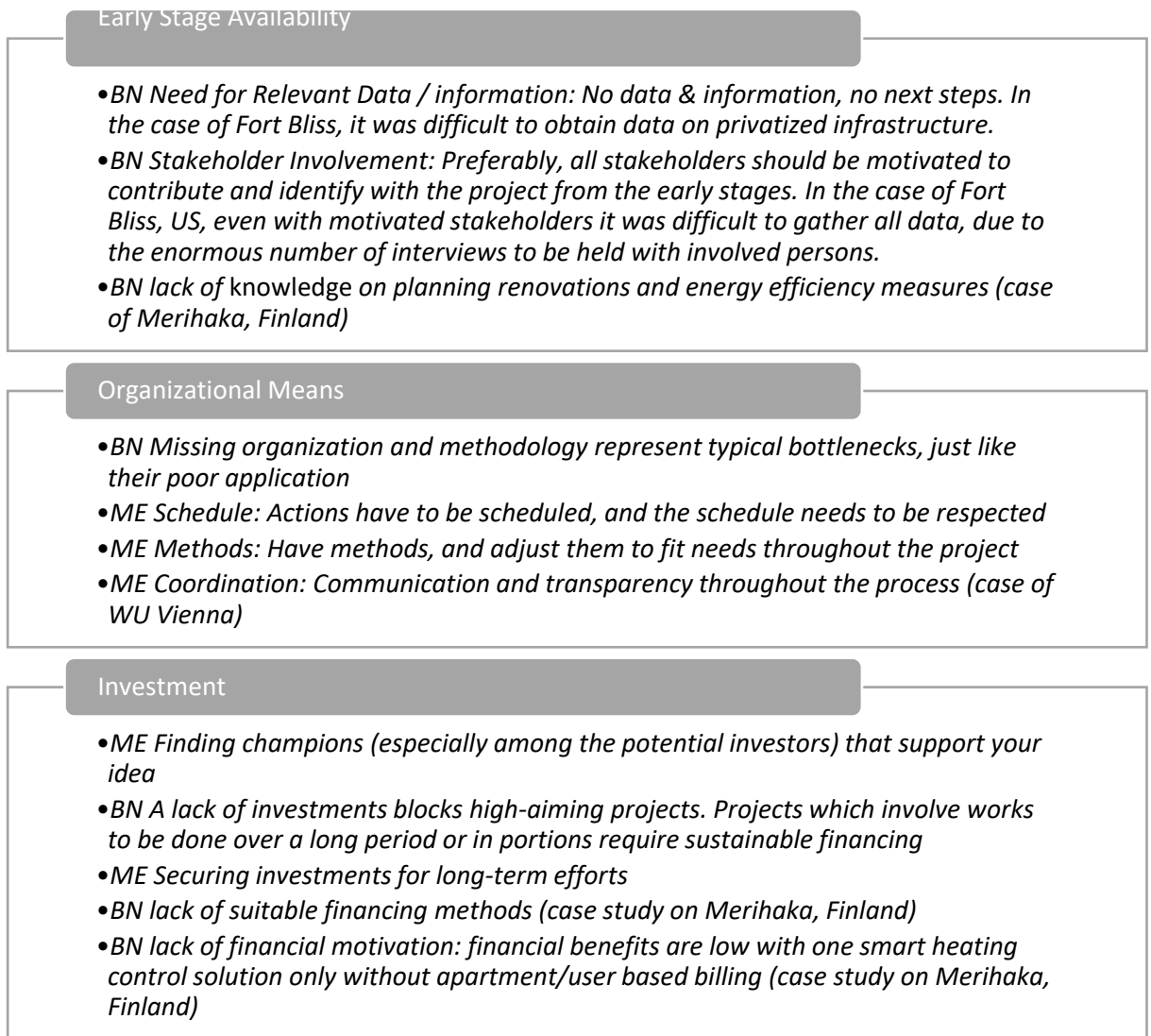

**Chart 2. Bottlenecks (BN) and means to overcome (ME) that were reported in the case studies.**

## 4.3 Lessons learned

Chart 3 lists the major lessons learned reported by those who studied best practices or who led these projects.

### *Synergies*

- *Address multiple problems and challenges at once for larger impact and reduced investments.*
- *Combine different infrastructures and disciplines in your approach.*
- *Even if certain infrastructure measures are only due in a number of years, think of them as well, to avoid lock-in scenarios and stranded investments.*
- *1+1>2*

### *Innovation*

- *A novel combination of things (read: concepts, technologies, approaches, methods) may offer huge potential even if appearing questionable at a first glance.*
- *Look for innovation in concepts, technologies and people.*
- *Reflect, not only for checking your progress, but also to reflect on what you have done and why.*

### *Cooperation*

- *Cooperation and open dialogue with peers are vital.*
- *Failure is a great way to learn something, yet it does not hurt to talk to others beforehand.*
- *Knowledge transfer, dissemination and good documentation is key.*
- *Include, do not exclude.*
- *Establish a “communication hub” to create a shared vision.*
- *In the case of SunZEB (Finland), the buildings act as energy sources. Close collaboration between energy concept developers and architectural and technical planners of the building is necessary for successful results.*
- *Cooperation of neighbouring buildings’ and district level collaboration can be considerably improved to reach shared targets more easily, to reduce risks and to lower the bar for the need of individual investments (Merihaka, Finland).*

### *Financial Resources and Business Models*

- *Technically and economically sound concepts still need a framework for implementation and an investor who wants to go through with the concepts.*
- *Early involvement of investors! (if needed!)*
- *The project owner, e.g., a campus owner, a public utility or a consumer-co-operative, is engaged in the planning and investment. In case the project is profitable, the project owner can finance 100% of the investment at lowest interest rate (Danish Case Studies, Ramboll).*

### *Consider Side Effects and Resilience*

- *While being an “Early adopter” or “Frontrunner” means additional complexity and courage, later benefits may outweigh this point.*
- *Integrate resilience and sustainability into your energy master planning initiatives as soon as possible, instead of waiting for the inevitable crisis, natural disaster and change to spur you to action.*
- *Do not wait and react, instead act and plan beforehand. Challenges, future and present, will not disappear if you neglect them. See these challenges as a chance to evolve, not as a threat.*

**Chart 3. Major lessons that have been learned by those who studied best practice cases.**

## CHAPTER 5. LESSONS LEARNED ON ENERGY MASTER PLANNING

This chapter summarizes issues drawn from the studied cases that involve the design of energy master planning process. Information and statements below are drawn from major success factors, bottlenecks, and lessons learned reported in the case studies. The answers to these questions have been grouped to according to the previously summarized categories.

### 5.1 Resiliency Analysis and Gap Evaluation

The case studies show that resilience was addressed by asking stakeholders to identify known risks, critical functions, and strategies to adopt to maintain supply system availability in challenging situations.

Answers to those questions indicate that often regulation and standards required by law are the strongest drivers for resilience. In many cases, emergency power units (usually diesel fed engines with kinetic storage for immediate load) were installed to reduce damage by power outage. In other cases, resilience was increased by combining the thermal energy supply system of two close-lying areas and thus creating a n+1 redundancy for generation and distribution, like in cases on Danish district heating systems. Here, resilience is a by-product of cost efficiency; redundancy allows users to always choose the most cost-effective energy source.

For backup power supply, the most common solution is still kinetic plus diesel fed units, which serve only very limited purposes such as emergency ventilation and lighting as well as server systems and life sustaining measures in hospitals. To date, microgrids are being realized in the United States and supplied from gas-fueled CHP plants at the site to increase resilience where the power systems are degenerating. Micro grids are not common in other European countries, as the power grids are reliable, but used in some cases, e.g., the Danish Technical University, to avoid distribution tariffs, as the costs of operating their own low voltage grid are lower than the distribution tariff from the utility. Even a large gas CC CHP plant at the campus is not connected to the campus grid, but is connected to the utility grid and operates on the market for energy and regulation.

The Guam, U.S. Army case study highlights the role of district systems for providing resilience. Here, demand reduction was shown to cost-effectively improve resilience. Another measure taken that has a side-effect on resilience is to actively manage responses from the electric utility to reduce load under an interruptible tariff notice. For example, see the Fort Bliss, U.S. Army installation case study. Another lesson learned from the case study at Fort Bliss was that many solutions implemented to reduce risk are operations-based and low cost. When planning for these U.S. Army sites, the procedure developed in context of Annex 73 has been applied, as described in Urban et al. (2020).

In the Australian case studies, it was found that existing energy or water supply cannot cover demand peaks. Here, thermal energy storage was the method of choice. Resilience is increased via demand shifting.

In summary, one can say that rare events are only considered if required by local/national legislation, unless resilience is a by-product of cost efficiency or is specifically required by critical functions or sensible function owners, as in the cases of U.S. university campuses:

- Resiliency is key for the Medical District and the microgrid at the University of Texas Austin, which has 100% onsite generation capacity, including N+1 redundancy for prime movers under 99% of all load conditions. This provides flexibility to serve the critical research customers and Medical District. UT Austin also has a redundant electric interconnection to the Austin Energy grid to provide 2N+2 system redundancy for nearly all system load conditions.
- The campuses have integrated resilience into energy master planning initiatives as soon as possible instead of waiting for the inevitable crisis or natural disaster to spur the administration to action.
- Combined with efficient and sustainable energy and water strategies, resilience efforts can reduce operational and maintenance costs in addition to reducing (or avoiding entirely) the costs of responding to a catastrophic event (e.g., Figure 7). Insurance premiums may be significantly lowered, too (case study on UT Austin, USA).



**Figure 7. Tractor providing power to a mountain resort during 3-hour blackout. This is a typical mobile backup method used in agricultural and sparsely populated areas (February 2020, Sommeralm in Austria. Source: AEE INTEC).**

Available resources include occasions for local energy production and storage, as well as supply from existing energy infrastructure like power lines, gas tubes, and district heating. Other significant resources reported in case studies include know-how, experience, and sympathetic regulation, just like access to mobility networks.

As mentioned above in the section on resilience, supply via grid may be limited, especially at demand peaks. In some of the case studies (especially hot climate regions, e.g., Australia), the reduced electrical consumption and demand benefited both the building owners (university) and the energy operating company.

Another important local resource is mobility. One case emphasized the importance of finding the right lot for the campus. The chosen area can be used for local energy generation and even more importantly, guarantees a high accessibility by public transport. The lot and its surroundings were essential and strongly determined the outcome (study on WU Vienna, Austria).

The existing knowledge and experiences of the research team and the included network in similar projects are important resources (case study on HFT Stuttgart, Germany).

Another success factor reported is the cooperation with an institution holding experience in similar projects, like offered in an open dialog with American universities (study on University of British Columbia (UBC), Vancouver, on IDEA cooperation in case).

General information on how available resources can be included into energy master planning is found in chapter 4 of the guidebook, where local circumstances and resources define constraints for the master planning process.

## 5.2 Organizational Matters

Organizational matters range from team building and internal communication, to involvement of third parties. This section summarizes lessons learned on organizational matters.

Generally, good communication and team spirit on the working level of the team enable success.

If more parties are involved or interested, communication is essential, and slow communication leads to bottle necks:

- Communication:
  - In one case, communication with administration of university and other stakeholders outside the campus was reported to be a major bottleneck (case study on HFT Stuttgart, Germany).
  - In another case, the operational planning effort was led by staff in the Department of Planning and Economic Development. However, much of the adopted master plan was informed by other departments in the city, and while they were responsive, the potential existed for progress to get held up (case study on Ford Site, St. Paul, USA).
- Team / Structure:
  - A well-rounded project team that encompasses major stakeholders has been reported to be an important success factor (case study on UC Davis, USA).
  - If owner and user are not the same, it is important to find the right organizational structure to allow owner and user/tenant to develop the project together, define common targets, and fulfill all requirements (case study on WU Vienna, Austria).
  - In the Danish case studies, it was also shown that it is a good idea for city district heating companies and campus owners to cooperate to find the best common solutions.
  - The choice of the best planning form for the project is important: *“integral planning, with the responsibility lying with the main planner allowed for good solution”* (case study from Innsbruck, Austria).

In Denmark, energy planning has become a natural part of urban planning in the local community, and there is obligation to plan for cost-effective heating and cooling in cooperation with local stakeholders, first of all with the energy utilities, e.g., the public utility

who owns the infrastructure. This framework contributes to create a modern and resilient energy supply infrastructure.

The case studies show that it is important that all stakeholders provide all relevant information, which allows the planning authority to find the least cost solution and to prepare a stakeholder analysis that will indicate how the benefit can be shared among the parties.

**Commissioning** is not an integral part of planning, but can be considered in the planning process. The Austrian case studies show how cost effectiveness can be improved by splitting construction work into feasible, competitive, yet still economic pieces for commissioning (WU Vienna, Austrian case study).

### 5.3 Financing/Economics

This section summarizes remarks collected in the case studies regarding financing and economics. Generally, the evaluation of case studies shows that most often a “business-as-usual” business model is in use that assigns the major cost and benefit risks to the building or community owners. Most business models assume that the public community is taking all performance and investment risks. The deeper analysis of three cases showed that some business models such as energy supply contract or even energy performance contracts are not known or not considered at all. Also, utilities and Energy Service Companies (ESCOs) do not provide specific services for net zero energy (NZE) communities.

In the Danish case studies, ESCO-companies are not necessary because the public utilities and consumer cooperatives can manage projects alone or with help of consultants, and because they can obtain loans to finance all necessary costs. Experience drawn from the case studies shows the importance of devising an accurate business case, and of considering public funding and avoided costs.

- It is important to create an accurate financial business case around forecast electrical power prices. Knowledge on future carbon pricing and the carbon tax can help increase the accuracy of the business case and thus facilitate financial planning (case study on JCU Townsville, Australia).
- In the calculations, one should consider the additional savings achieved at the other side of the meter, due to cold mechanical rooms. In one case study, this amounted to an unexpected 10% savings (case study on UBC, Canada).
- Life cycle costs and energy implications should be controlled at decision points (case study from Innsbruck, Austria). Ideally, one would consider demolition as well.
- Acquisition of appropriate financial subsidies allows for the development and tracking of non-standard procedures (integral planning, innovative measures, monitoring, life cycle cost analysis (LCCA) (case study from Innsbruck, Austria).
- Permanent monitoring and temporal monitoring do lead to similar costs (case study from Innsbruck, Austria).
- In one case, a foundation grant was used to fund a series of planning studies conducted, including energy studies. This enabled an energy consultant team to evaluate onsite energy system options for the site, including technical and financial feasibility (UC Davis, USA).
- Leverage alternative funding to support project implementation (case study on Fort Bliss, USA).
- Life cycle cost (LCC) calculations show that low-tech solutions have lower life cycle costs (case study from Innsbruck, Austria).

- Another important issue is to check and evaluate use of local and sustainable materials as well as carbon embedded in materials.
- In a big project, it is very important to use more than just one method to check costs (case study on WU Vienna, Austria).
- Different options for the financing of the proposed measures were considered and discussed with the project-partner “Stuttgart Financial” and other experts. Among them were intructing, contracting, green bonds, or crowd-investing. In the end, the Department of Treasury Baden-Württemberg agreed to finance the project such that the other options were not needed anymore. However, the ideas can be applied to future projects (case study on HFT Stuttgart, Germany).
- In the Merihaka case study in Finland, large buildings with privately-owned apartments needed to be upgraded. To resolve issues around financing when supporting government funding is missing, the local energy company, Helen Ltd., is active with a business case and will be creating new business model studies as part of project actions, and will thus contribute to achieving a large impact.
- First studies on the business cases for Merihaka have included the Political, Economic, Social, Technological, Environmental, and Legal (PESTEL) and Strengths, Weaknesses, Opportunities, and Threats (SWOT) analyses as well as TALC methodology that identifies customer profiles to see how society is prepared to accept it. Quick summaries of market size and a porter diagram was prepared for the project partners, the energy company, and subject matter experts (SMEs), which considered the power needs and capabilities of consumers and suppliers, the threat of rivalry, energy substitutes, and new entrants into the marketplace.
- In the NTNU Gløshaugen campus case study, four energy efficiency packages were introduced for energy use reduction to help meet the target of a Zero Energy/Emission Neighborhood by 2050. Most buildings were built between 1951 and 1970 and were expected to undergo demolition; meanwhile, a plan to expand the campus through 2025 with new buildings built to the passive-house standard. It is most likely to achieve self-sufficiency for heating, but will remain largely dependent on electricity import from the grid until 2050.

In conclusion, the following deductions can be synthesized from best practice examples:

- In most best practice cases, investments will pay back in the long term by reduced operation and maintenance costs, and can thus be financed by loans drawn on the capital market on good terms.
- If the energy system has been privatized and is not owned by the campus building owner, it will be more difficult to renovate it since the investor does not profit from savings in operation.
- Most public entities (nations, municipalities, etc.) can get financing even for very long-term investments (>20 years). Private companies instead look for a return of investment on a shorter time period, around 4 years. The Danfoss, Denmark case study showed that it is possible to reduce energy consumption with established technologies and reach a very short payback time (here 3.1 years).
- Many countries offer financial support for renewable energy generation, innovative technologies, or outstanding procedures. Such subsidies can help to reduce payback time.
- Resilience can be obtained in many ways, ranging from UPS units for each critical function to redundant production and delivery systems. Danish case studies show that redundant production and supply systems can also be used to exploit price variations in the energy supply, and thus reduce operation costs.

## 5.4 Framework

The term “framework” denotes the external factors that affect community master planning, like nation-wide regulation on energy use or planning procedures, and project specific goals. The framework often defines what measures to apply and which solutions to prioritize. The general guideline for community master planning, i.e., that you “hold it in your hands,” can also be seen as framework since it gives advice on tools and procedures.

Here, lessons learned drawn from the case studies on different types of frameworks are:

- Framework for assessment of options:
  - It is important to have a framework with which to assess alternative options.
  - However, it is important to consider the overall framework at least one level above the level of the project, e.g., a project for assessment of investments in buildings has to be assessed at the campus or city level and be compared with alternative options including this level. Likewise, a project for assessment of investments at the campus level has to be assessed at the city level or national and be compared with alternative options including this level (Ramboll, experience from Danish case studies).
  - In one case, high-level criteria for energy efficiency and sustainability led to better than usual results, because they were defined early (should be before commissioning to planner team) and checked throughout the process. The same applies to costs (case study from Innsbruck, Austria).
  - The framework deployed on one project consisted of an economic evaluation of the lifecycle cost, an evaluation of whether the option would align with campus initiatives, and whether the solution would provide sufficient reliability and redundancy. (case study on UC Davis, USA).
- About framework for implementation:
  - In one case, although a new vision had been created for the site, a new developer who would purchase and develop the site may not find it feasible to implement all the ideas and concepts laid out during the City-led visioning for the site within the timeframe needed for horizontal and vertical development to proceed. While the city conducted a significant amount of study to ascertain the financial and technical feasibility of a district energy system, more focus could have been placed on implementation frameworks to better prepare for the period between identification of a developer and execution of a development agreement (case study on Saint Paul, Minnesota, Ford Site, USA).
  - The city is also considering how the lessons learned from large district projects can be translated to smaller, parcel-scale projects. One important conclusion from some case studies is on the possibility to draw from pilot studies to modify the legislation/regulation framework (case study on Saint Paul, Minnesota, Ford Site, USA).
  - City staff can lead a process of active community engagement and act as a hub for all city departments to create a shared vision that optimizes community benefits from the redevelopment of a property. As the city works through the due diligence period with the developer, staff are developing a better understanding of how to define expectations and policy in advance of projects being initiated (case study on Saint Paul, Minnesota, Ford Site, USA).

For information on framework in form of goals and constraints consult Table 5, chapter 4, and Annex A of the guidebook.



**Table 5. Framework conditions to be considered regarding later planning and later phases.**

Phase	Details	Examples
Operation	Availability of personnel	Denmark/Greenland
Acquisition	Low-tech costs less	
Monitoring	Optimization Evaluation before bringing methods to other districts	Austria/Innsbruck, Finland/Merihaka
Planning	Privatized infrastructure Campus growth	USA /Fort Bliss Norway/Gløshaugen, Trondheim

## 5.5 Technology

This section presents lessons learned from case studies on use of technology. Changing climate and disruptive events can challenge supply energy supply. Innovations and new technologies can help to create and maintain efficient, resilient, low-carbon energy systems. In the following discussion summarizes lessons learned on technology. Outcomes range from general remarks to very specific suggestions.

- The challenge was to deliver system capacity that covers high demand days (case studies from Australia)
- Use of innovative technologies holds difficulties. One needs to define:
  - Technical requirements for feasibility
  - Critical factors like error-proneness of control systems, space requirements, etc.
  - Conditions for cost effectiveness and cost drivers
  - Criteria for the request for proposal (RFP) (case study from Innsbruck, Austria).
- In the Merihaka, Finland case study, the building envelope turned out to offer sufficient insulation. Thus the key intervention in the retrofitting process to lower energy consumption was the installation of smart controls for management of apartments' heat and electricity demand: "smart heating control is applied with added focus of testing heat demand response to optimize energy systems and implement the human thermal comfort study with a QR code feedback system (based on the Human Thermal Model (HTM) developed by VTT). Together with HTM, predictive algorithms are also used to optimize energy use to achieve savings."
- "The company has been first mover with regard to new technologies in the pit storage in large scale. This has caused some problems and reduced the economic benefit the first years of operation. It has however been to the benefit of the next generation of storages, e.g., a storage pit in Toftlund not far from Gram, which has learned from this experience and managed to avoid holes in the liner during the construction" (case study on Gram, Denmark).
- Consider the huge benefits of reduced power consumption, costs, and carbon equivalents, which can be raised from a centralized plant (case studies on central cooling, Townsville and Cairns, Australia).
- Include plans on future thermal load growth and allow for system expandability to meet these future loads (case study on UBC, Vancouver, Canada).
- Substitution of technology offers opportunities: "The steam to hot water conversion project ... eliminated \$190 million in deferred maintenance costs, reduced operating costs, improved safety and resiliency, and dramatically reduced energy and water consumption" (case study on UBC, Vancouver, Canada).
- Consider the transition period, i.e., what to do with new buildings that cannot connect to new technology (e.g., hot water) yet should connect to steam (old technology being eliminated) (case study on UBC, Vancouver, Canada).

- Operation mode of chillers: “Ensure that the centralized centrifugal chillers are run highly loaded, for as long continuous periods as possible and do not surge” (case studies on Townsville and Cairns, Australia).
- Consider the structural design parameters for the modular tank for hot/cold water storage (case studies on Townsville and Cairns, Australia).
- Ground water can be a powerful source of energy (case studies on WU Vienna, Austria).
- Process steam scoping. Several labs and or process requirements were not captured under original scoping; after change from steam to hot water heating, they were out of steam. (case study on UBC, Vancouver, Canada)
- Provide cost-effective alternatives to generators (e.g., storage, photovoltaics, demand response (case study on Fort Bliss, USA).
- Whether a specific innovative solution is possible can depend on the specific situation, e.g., as reported in SunZEB case study from Finland, “district cooling with access to a heat pump that can reuse the energy is needed.”
- Moreover, a campus can provide feedback on its surrounding energy system, making adaptations of the system necessary: “If a large number of SunZEB buildings are developed, adapting the district energy system for the loads is needed” (SunZEB case study from Finland).
- There is constant waste heat with capacity of 1MW from IT center in the campus, which is already used for heating and will contribute to in heat supply. Heat pumps are expected to supply around half of the total heating use. The contribution to electricity from solar PV is less than 10% in new buildings and less than 5% in existing buildings. The contribution from a biogas-based CHP to both electricity and heating is negligible (case study of NTNU Gløshaugen campus, Norway).

The case studies showed that various methods are used for storing energy (Table 6). Here there is certainly space for innovation. In fact, storage is one of the big research topics, ranging from chemical storage (batteries), to fuels (hydrogen, biogas), to heat (latent and sensible). Storage solutions are anticipated to grow rapidly in the next years.

**Table 6. Storage solutions featured in case studies.**

Storage Type	Details	Examples
Thermal water storage	Hot water	Denmark/Gram, Finland
	Cold water	Australia, Finland, Denmark
	Ground water	Austria/WU Vienna, Denmark
Fuel storage	Hydrogen	Denmark/Nymindegab

Generation, on the other hand, has been the subject of much research over the past decades, and is increasingly integrated in solutions, as the case studies illustrate. Table 7 lists some examples. Generic information on technologies is presented in Appendix F of the EMP Guideboo.

**Table 7. Generation types featured in case studies. The list is not complete, only some exemplary case studies are listed for each generation type.**

Generation Type	Details	Examples
Fuels	Oil, Natural Gas, Biomass	Denmark, USA
Ambient heat	Ground water river	Austria/ WU Vienna
Ambient heat	Sea	Denmark, Finland
Waste heat	CHP	USA, Denmark Copenhagen
Waste heat	From cooling	Finland, Denmark/Taarnby cooling

<b>Waste heat</b>	From Building	SunZEB, Finland
<b>Recovery</b>	Of exhaust air heat/cold	Austria/ Innsbruck (only heat) Norway/ Gløshaugen
	Of wastewater heat	Denmark/ Taarnby cooling
<b>Photovoltaics</b>	USA, St. Paul	
<b>Cogeneration of Heat/Cold</b>	Heat Pump	Finland, Denmark/Taarnby cooling
<b>Waste heat</b>	Heat pump	NTNU Gløshaugen campus, Norway
<b>biogas</b>	CHP	

## 5.6 District Energy Systems

District energy systems play an important role in the Annex 73 ‘Towards Net-Zero Energy Resilient Public Communities’ case studies. This section summarizes lessons learned about district energy systems, from steam to hot water, from heating or cooling to a combination of both, and the integration of power. Moreover, the discussion refers to the specific case studies to consult for additional information.

### 5.6.1 Advantages of district heating and cooling

With district heating and cooling, it is possible to

- use efficient waste heat from industry and power generation, in particular at low temperatures
- include energy from different sources including renewables
- include storage that enhances use from volatile sources
- choose generation source according to actual prize level, due to variable flow operation
- reduce costs for generation plants due to economy of scale
- react to power costs by choosing heat source accordingly (e.g., gas turbine or heat pump).

See case studies from Denmark for more details.

For district cooling, especially:

- storage reduces the dependence on power supply. If the local power system is at its limits, cold water storage can be part of the solution.
- Storage provides capacity, due to strong daily fluctuations
- Storage is an option to optimize operation and use of electricity

See case studies from Australia.

Advantages of combining heating and cooling systems include

- Waste heat from cold production can be used for heating and waste cold from heat production can be used for cooling.
- Heat pump for combined heating and cooling can be combined with ground source cooling (Aquifer thermal energy storage, short: ATEs)
- Cooling with small devices on building level has some disadvantages:
  - In cold regions this heat is lost, while it is needed elsewhere.
  - In hot regions, this heat further warms up the environment, aggravating the situation, while domestic hot water is usually still provided with fossil fuels.
  - Problems with noise, visual impact and space.

- In regions where heat and cold is needed concurrently, use one heat pump for combined cooling and heating.
- In regions where heat and cold is needed in different seasons, consider seasonal thermal energy storage e.g., ATEs.

See case studies from Finland, Denmark and Austria (WU Vienna) for more details.

Advantages of CHP include

- One can react to supply costs by choosing appropriate generation plants e.g., CHP vs. heat only.
- Combined with thermal storage tanks, the extraction CHP plant can generate power only at power peak hours and generate combined heat and power in the most optimal way.
- Combined with thermal storage tanks, the back-pressure CHP plant and gas engines can generate combined heat and power in the most optimal way, e.g., at maximal load in over peak hours.

See case studies from the United States and Denmark for more detail, especially university campuses, towns, and cities.

Generally, case studies show that district infrastructure including generation and storage enhance local community value creation.

Table 7-1 in chapter 7 of the guidebook contains a full list of disadvantages and advantages of district thermal energy systems.

## 5.7 Planning

This section presents all lessons learned regarding planning. For easier review, we distinguish between different categories, including method, goals, simulation, costs, monitoring, and involvement of user/operator.

Planning method.

- To enable innovative solutions, use integral planning at the level of society to include all potential sectors (Danish cases, Campus Technik Innsbruck).
- Ensure that the planner has access to the necessary vital data from all stakeholders and facilitate an open cooperation.
- Beyond access, planning should be done directly with stakeholders and legislative bodies as the engagement practices have many benefits including less opposition for zoning change, helping the developers showcase the clients they are building for to directly respond to the needs of the market and business models that show positive cash flows and increased rental/ sale numbers in less time. These positive side attributes will offset some of the perceived risks of the private developers. Beyond institutional builders, community and private developers should be part of the equations of sustainable development metrics.
- To reduce barriers and promote use of digital methods, the public authority can offer information to planners: In case study on Merihaka, the City of Helsinki has collected extensive data on buildings' energy information for open source use in the Energy and Climate Atlas as an integral part of the 3D City Model, <https://kartta.hel.fi/3d/atlas/#/>.
- Moreover, in the same project, VTT Technical Research Centre of Finland has performed a comprehensive technical and cost efficiency study on suggested renovation measures

for particular type of apartment buildings– information table embedded as pop-up clickable feature onto the model Merihaka apartment buildings).

- Use simulation tools, e.g., EnergyPro for simulating the most optimal operation and network analysis systems for design of the energy carriers (Danish case studies, e.g., Taarnby district cooling).
- Create different scenarios and compare them, as has been done in Merihaka case, Finland, by using the Multi Objective Building Energy Optimization (MOBO) study, to map best scenarios and combinations of energy conservation measures. In Merihaka case, energy, emissions and life cycle costs have been compared for a period of 25 years.
- Use life cycle cost analysis including actual costs in a net present value (NPV) analysis based on a reasonable lifetime and discount rate, including residual value for infrastructure for which the lifetime exceeds the project period (Danish case studies).
- Note: life cycle should start at the acquisition of the land if demolishing and soil remediation is required.
- For non-standard energy supply and building components and rarely used technologies, invite manufacturers to cooperate in the planning phase:
  - “No construction company would deliver the innovative prefabricated facade as it was planned, thus the design had to be adapted, including standard elements to achieve the aspired result” (case study in Innsbruck, Austria).
- In U.S. case studies on Army campuses, planning for resilience and sustainability procedure described in Jeffers et al. (2020) is applied.
- In the case study of NTNU Gløshaugen campus, energy efficiency measures were considered under scenarios of standard and ambitious renovation activity and demolition.

Goals, Framework.

- Define energy and cost limits in an early planning phase (preliminary design) (case study from Innsbruck, Austria).
- Coordination of some tasks need more adjustment to prevent duplication of efforts (e.g., refurbishment scenarios should be final before simulation, etc.) (case study on HFT Stuttgart, Germany).
- Optimization variants (e.g., regarding Heating, Ventilating, and Air-Conditioning [HVAC]) should be defined and assessed in the preliminary phase.
- Determine whether the university campus is able to achieve the goal of Zero Energy/ Emission Neighborhood 2050 and define the most important factors influencing energy demand and GHG emissions reduction (case study of Gløshaugen campus, Norway).

Simulation.

- Simulation tools (Table 8) can provide resilient results but need reliable input information (case study on HFT Stuttgart, Germany).
- Detailed simulations are not necessary in some situations (case study on HFT Stuttgart, Germany).

**Table 8. Software and tools reported in case studies.**

Type of Software, Application	Application Used In Case Studies
Geographic information system	ArcGIS

Type of Software, Application	Application Used In Case Studies
<b>Simulation of energy systems</b>	SYSTEMRORNET (hydraulic analysis in Danish cases) SMPL/Net-Zero Planner (U.S. Army case studies) Vision Simulation Tool from AECOM (U.S. Army case studies) Comprehensive Energy Investment Plan (CEIP) Vision Scenario Planning Tool (U.S. Army case studies) IDA-ICE (SunZEB case study, Finland) IDA-ICE (NTNU Gløshaugen campus, Norway) INSEL and PVsol for PV (case study on HFT Stuttgart, Germany) PVsyst for PV (NTNU Gløshaugen campus, Norway)
<b>Business</b>	Excel sheets for business models and calculation Ramboll business plan model in Danish cases Life cycle costs (e.g., econ calc, Austria) Excel tool for economic efficiency, inhouse by HFT Stuttgart
<b>Resilience</b>	Energy resilience analysis ERA tool developed by MIT (in U.S. Army case studies)
<b>Optimization</b>	Use of monitoring data e.g., on flow and temperature of wastewater (Denmark) Mentor Planner for optimized operation(Denmark) ENERGYPro: simulation of cost- optimal operation (Danish cases)
<b>Building Comfort Simulation</b>	IDA-Ice for Dynamical building simulation of indoor comfort (Austrian Case studies, Merihaka, Finland) PHPP passive-house planning platform (Austria, Germany) Daylight Simulation
<b>Surrounding</b>	Wind simulation for outdoor comfort (case study on WU Vienna)
<b>Building Design</b>	CAD software for design
<b>Building Energy Use</b>	Energy performance certificate according to ÖNORM (Austria) Certification tool (PHphit) (Germany) SimStadt simulation platform (Germany)
<b>Project organization</b>	Project Platform Project leaders and construction supervision used different cost tools to control cost development (WU Vienna, Austria)
<b>Optimization, Hybrid Solutions</b>	<b>Multi Objective Building Performance Optimization MOBO</b> (Merihaka, Finland)

#### Monitoring.

- Consider monitoring already in the planning phase (case study from Innsbruck, Austria).
- Permanent monitoring and temporal monitoring do lead to similar costs. (case study from Innsbruck, Austria).

#### Involvement of Users/Operators.

- Complex control system in one of the buildings requires the tenants' attention and know-how (case study from Innsbruck, Austria). Training can help remove barriers to behavior modification.
- In case of complex technical installations involve the future operator from an early phase (case study from Innsbruck, Austria).
- It may be difficult to keep and attract qualified staff to ensure efficient operation and a high maintenance standard in remote areas (case study from Greenland, Denmark).

## 5.8 Motivation/Mobilization

Motivation and engagement are always essential. In some case studies, they were mentioned as driving factor for reaching a high-level solution.

In case of demand for additional space, a required reduction of energy use can leverage the process to reach sustainable systems:

*Institutions of higher education are requiring that campus growth go hand in hand with objectives of reliability, efficiency and carbon reduction on campus when evaluating options for expanding or managing existing district energy infrastructure (IDEA, USA).*

- The motivation of campus users and owner is a success factor: “Both tenant and owner have know-how on building, and were interested in achieving a high-level results.” (case study from Innsbruck, Austria).
- Engagement of management team (case study on HFT Stuttgart, Germany) is essential.
- In the case of UBC (USA), the economic impact of a carbon tax played a strong role in reducing natural gas use and moving to fuel diversity by adding bioenergy (case study on UBC, Vancouver, Canada).
- Certification and prices: “In November 2017, the 14-acre Dell Medical District at The University of Texas Austin became the first project to hold SITES, LEED, and PEER\* certifications, making it one of the most holistically sustainable and resilient facilities in the world.” (case study on UT Austin, USA).
- The engagement of stakeholders increases acceptance and may in this way reduce future costs for adaptations: “The non-technical planning success was the dedication of time and effort the City of Saint Paul planning department put into extensive community stakeholder engagement from 2007 through 2017. This stakeholder engagement effort was visible and reached the community through:
  - Over 80 presentations to business, civic and non-profit groups
  - 45 public meetings with over 1300 people attending those meetings
  - Over 100 articles in print, radio and television media
  - Thousands of ideas and comments were received through this engagement effort, and the key themes from the community were able to be incorporated into the vision statement and six guiding principles that were ultimately adopted by the City Council and Mayor as the Ford Site Zoning and Public Realm Master Plan. The new vision for the site, rather than the existing industrial use, was available to developers as they made bids on the site.” (case study on St. Paul, Ford Site, US).
- In case of Merihaka, Finland, private apartment owners need to be motivated and included. An energy advisor has been brought on board to assist with engagement of private stakeholders and to continue and trigger further co-creative discussions. Another activity was performing a study on renewable energy and discussion of results with the local building owners to acquire more feedback on their interests.
- The retrofitting work of the privately-owned apartment buildings was first introduced through pre-pilot experiences. This helped in creating a level of acceptance for the project actions (case study on Merihaka, Finland).
- “Discussions with the local housing association chairpersons aim to motivate them and encourage exchange of knowledge to raise more awareness on the energy matters. Some events are open to public and some are specifically for the building owners in the

---

\* Performance Excellence in Electricity Renewal (PEER)

form of living lab co-creation sessions. As an example, three events consist of cascading workshops with experts, residents and interested stakeholders, such as solution providers and financiers for energy retrofits. This exchange of ideas aims towards matching the preferences and transforming retrofitting on district level. Joint discussions between the housing associations, the district real estate management company, local energy company and energy optimization study provider are continuing to have more detailed discussions. The program on the city level is supported by the administration and conducted in conjunction with the City Strategy” (Merihaka, Finland).

- Successful projects serve as role models: “The CNPRC will be used to demonstrate the feasibility, cost, effectiveness, and challenges faced in implementing energy efficiency and environmentally friendly” (case study on UC Davis, US).
- One of the pilot projects of the Zero Emission Neighborhoods in Smart Cities (ZEN) Centre is “Knowledge Axis Trondheim,” which is a north-south bound route in Trondheim with high concentration of knowledge institutions. NTNU Gløshaugen campus is situated along the Knowledge Axis and the university is one of the primary actors in the project.

## 5.9 Current trends and future solutions

To summarize, some trends may be observed in the case studies:

In many cases, power demand has strongly increased, due to use of electrical equipment and cooling demand, which may again be caused by electrical equipment and higher outdoor temperatures. This results in low summer comfort and **overheating**, rising costs for cooling, and sometimes even **capacity overload**.

Measures applied include

- Replacement of electrical devices (e.g., lighting) by more efficient ones
- Shading
- Use of renewable cold, e.g., ventilation (day and night), ground water etc.
- Centralized cooling systems with TES to shave demand peaks and move consumption from day to night.

Experience from case studies shows that generally there is often large potential using **standard/well-tried technologies**. These include efficiency measures like insulation of envelope, upgrade of building technology, and use of heat pumps, renewable generation, and heat storage.

Where district heating is well-established, **thermal supply networks** are being **expanded** or combined with each other to replace fossil fuels with renewable energy and surplus heat and to increase the overall energy efficiency. Moreover, thermal storage capacity is being increased to use more thermal and electrical energy from volatile regenerative sources.

In Denmark, integrated energy systems that act as so-called **virtual battery**: The district heating is supplied from a CHP plant, a heat pump, an electric boiler and storage units. The system is operated in response to the electricity market prize.

In some cases, the **heat pump** can deliver cooling to district cooling in combination with an aquifer thermal energy storage. In many cases, both for district cooling and district heating networks, **thermal storage** is being installed to avoid stress by consumption peaks and to optimize the production and operation, and thereby reducing the risk of load shedding and blackout on warm and cold days (case studies from Finland).



One important leap is the **replacement of steam systems** by hot water systems. In Greater Copenhagen, one of many subprojects in the city center is to replace the old steam system with hot water district heating and thereby reduce the costs and increase the efficiency, and increase the use of renewable energy and the level of resilience. This experience is valuable for U.S. campuses, as 95% of all campus heating systems are steam based.

In **single ownership areas** such as university campus, EEMs can be undertaken to reduce demand peaks, e.g., building shell renovation and replacement of energy-consuming devices by more efficient ones, as the campus owner is able to optimize the whole chain from thermal comfort in buildings to use of resource and fuels. Thereby the campus owner can also find the **right timing** for modernizing building installations and optimizing the insulation and HVAC system with respect to the real costs of energy supply (HFT Stuttgart, Germany).

If the energy supply system is owned by the city or consumers like in Denmark, the utility aims to minimize the cost for all consumers in total. In fact, this leads to optimal solutions as in single owner campus situations. **Cost-based tariffs** are important to stimulate efficient use of energy.

For **backup power supply**, the most common solution is still kinetic plus diesel fed units, which serve only very limited purposes such as emergency ventilation and lighting as well as server systems and life sustaining measures in hospitals. To date, **microgrids** are being realized in the United States and supplied from gas-fueled CHP plants at the site to increase resilience where the power systems are degenerating. Micro grids are not common in other European countries, as the power grids are reliable, but used in some cases, e.g., the Danish Technical University, to avoid distribution tariffs, as the costs of operating their own low voltage grid are lower than the distribution tariff from the utility. Even a large gas CC CHP plant at the campus is not connected to the campus grid, but is connected to the utility grid and operates on the market for energy and regulation.

For existing large areas, the **planning process is complex**, and includes consideration of future use and energy costs as well as maintenance and operation of existing infrastructure. Implementation plans for energy systems cover many years of actions to increase efficiency, resilience, and reliability. These plans are important to allow for financing from a third party that needs a schedule and security.



Energy master planning considering resilience has been further developed in the framework of Annex 73, "Towards Net-Zero Energy Resilient Public Communities," and is being increasingly applied in planning processes. It helps to build a constructive and informed energy master planning process, allows to consider various aspect, and proposes procedures and solution sets for long-term implementation plans that lead to highly sustainable, cost-efficient, and resilient supply systems.

Requirement of energy security is growing due to the increased complexity of the built environment. First of all, it is a challenge to develop a low carbon energy system and integrate volatile energy sources. This is further caused by the use of electrical devices in many aspects of our lives, which ultimately challenges outdoor conditions and high standards of indoor climate. To provide for a resilient supply system, adaptations of our water and energy supply systems are necessary. Due to the complexity of requirements, many stakeholders need to be involved. The energy master planning process for single ownership areas and for local communities designed in Annex 73 "Towards Net-Zero Energy Resilient

Public Communities” helps to create resilient communities and is described in detail in the Annex 73 Guidebook.

# CHAPTER 6. CASE STUDIES

## 6.1 James Cook University Townsville Campus District Cooling System with Thermal Energy Storage, Australia

Case No.	Country	Location	Specific Type	Photo	Special Points of Attention
1	Australia	Townsville	Campus University		 cooling, cold storage
<b>Country:</b>		Australia			
<b>Name of city/municipality/public community:</b>		Townsville, Queensland			
<b>Title of case study:</b>		James Cook University Townsville Campus District Cooling System with Thermal Energy Storage			
<b>Author name(s):</b>		Behzad Rismanchi / Caroline Frauenstein			
<b>Author email(s):</b>		<a href="mailto:brismanchi@unimelb.edu.au">brismanchi@unimelb.edu.au</a> / <a href="mailto:caroline.frauenstein@jcu.edu.au">caroline.frauenstein@jcu.edu.au</a>			
<b>Link(s) to further project related information / publications, etc.:</b>		<a href="https://www.jcu.edu.au/tropeco-sustainability-in-action/sustainable-campus/energy/campus-district-cooling-cdc-system-averting-an-energy-crisis">https://www.jcu.edu.au/tropeco-sustainability-in-action/sustainable-campus/energy/campus-district-cooling-cdc-system-averting-an-energy-crisis</a> <a href="https://www.airah.org.au/Content_Files/EcoLibrium/2009/September09/2009-09-01.pdf">https://www.airah.org.au/Content_Files/EcoLibrium/2009/September09/2009-09-01.pdf</a> <a href="https://www.ergon.com.au/_data/assets/pdf_file/0006/149658/FINAL-ERG_A4CaseSheet_JCU.pdf">https://www.ergon.com.au/_data/assets/pdf_file/0006/149658/FINAL-ERG_A4CaseSheet_JCU.pdf</a>			

### 6.1.1 Background and Framework

In 2006, JCU’s Townsville Campus in Queensland, Australia was facing an energy dilemma, we had reached a point where our energy demand was close to that of the available electrical supply from the local Zone Substation – and we would not be able to implement our plans to expand our teaching and research facilities (physical footprint) without major infrastructure upgrades to the electricity supply - or a major rethink of our energy efficiency.

As we are in a tropical environment, air-conditioning our facilities was the most significant electrical power consumer, using almost 60% of the total energy for the campus – with little or no requirement for heating. Each building had been built with separate, standalone air-conditioning plants, and many of these were inefficient, outdated (several had been in use for 35 years) and in need of replacement. All our facilities use electrical power off the grid and there are no liquefied petroleum gas (LPG) or natural gas supplies.

Our Cairns campus had a small scale, centralized chiller facility (Figure 8) and we levered of this experience, with input from stakeholders such as Ergon Energy and consultants like McClintock Engineering Group to research alternatives and present a detailed business case for approval.

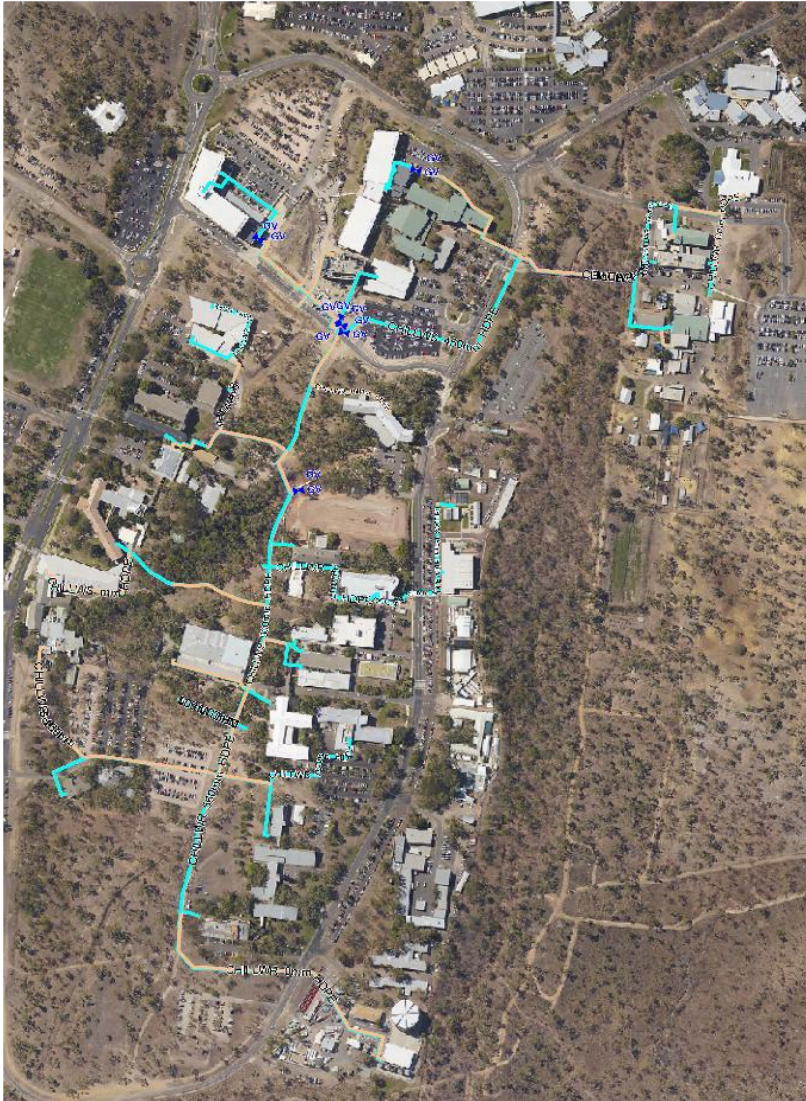

**Figure 8. Townsville chilled-water reticulation.**

Interesting 2007 Statistics and Plans:

- 255 hectares containing 28 distributed teaching and research facilities or 69,000 m<sup>2</sup> of air-conditioned space.
- Campus electrical maximum demand of 7.3MW.
- Power costs of \$2.7 million per annum.
- Development plans to add 25,200 m<sup>2</sup> of air-conditioned space by 2010 and another 25,000 m<sup>2</sup> by 2015, equating to 9.9MW in 2010 and 13MW by 2015 – both in excess of installed electrical network capacity

### **6.1.2 Innovative Solution**

Our solution, installed in 2008 and commissioned in 2009, is the largest centralized Campus District Cooling System in the Southern Hemisphere, where we installed a centralized chiller and thermal energy storage tank facility with an underground chilled-water piping reticulation to cool 69,000 m<sup>2</sup> of research and teaching facilities located in 28 different buildings on this tropical campus.

Our business case compared this sustainable, energy reduction opportunity with the alternative of installing additional high voltage feeders and increasing electrical consumption and demand on the campus.

The system was designed to run the chillers during periods of low campus load – in the night when the lighting and power loads are low – to charge the Thermal Energy Storage Tank (TEST). The TEST provides the cooling during the high demand lighting and power campus loads, typically between 08:00 and 17:00.

#### Interesting Project Statistics and Information:

- 12 Megaliter, modular, galvanized steel plate, TEST stands 16.5 m high and has an outside diameter of 32 m. Maintaining a thermocline and distinct stratification is critical. Insulation is provided by 2 x 50 mm layers of polystyrene grade insulation and the water seal by a 1.5 mm welded butyl rubber liner. Nominal capacity is 120,000 MWh(t).
- The system contains a total of 13 Megaliters of chilled water (CHW) in the TEST, and the 11.2 kilometers of reticulated piping (DN560 to DN110) is open to atmosphere and therefore treated with a molybdate corrosion inhibitor and various biocides and treatment additives. CHW is typically sent to the campus at 60 °C and returned to the TEST higher than 120 °C.
- Four, 4.2MW(t) rated Trane CVHG Chillers provide the system chilling capacity in the central energy plant. Primary CHW Pumps service the chillers while Secondary CHW Pumps provide the pressure to reticulate the CHW around the campus with Tertiary CHW Pumps located in each building.
- A Condensed Water system uses five induced draft counter flow evaporative coolers to each cool 200 liters/second of water from 370 °C to 310 °C with an air entering wet bulb temperature of 270 °C.

#### Energy Objectives

- Reduce Maximum Demand from 9.9MW to 5.4MW in 2010 with 94,000 m<sup>2</sup> of air-conditioned space.
- Reduce Maximum Demand from 13MW to 6.1MW in 2015 with 120,000 m<sup>2</sup> of air-conditioned space.
- Reduce electrical operating costs by 30%.

#### Current Status:

10 years after implementation, all objectives have been achieved or exceeded, given that the University Masterplan has changed and the anticipated growth has not materialized.

#### Interesting Statistics and Plans (see Table 9 and 10):

- Achieved 2017 campus electrical maximum demand of 7.0MW
- Achieved campus electrical maximum demand of 5.7MW in 2010 and 6.4MW in 2015
- 2017 power consumption costs reduced by 33% against Business as Usual (BAU)
- 85,000 m<sup>2</sup> of air-conditioned space attached to the Campus District Cooling System in 2017
- Maximum 2017, 24-hr consumption of 191MW(t) (Figure 9)
- GHG emissions reductions of over 10,600 tons per year.

**Table 9. General quantitative information on University Campus in Townsville (all measured data).**

	Urban scale of area [m <sup>2</sup> ]	Total gross floor area [m <sup>2</sup> ]	Heated floor area [m <sup>2</sup> ]	Population / Users in the area	Thermal energy demand [MWh/a]	Supply/return T [°C]	Thermal energy storage volume [m <sup>3</sup> ]	Cooling energy demand [MWh/a]	Electrical energy demand	Annual electric energy yield [MWh/a]
Before	2550000	69000	0	14165	36685	9/17	0		7.3	
BAU	2550000	120000	0			6/14	0		13	
After	2550000	85000	0	10563		6/12	12000	35157.4	7.0	6284.7

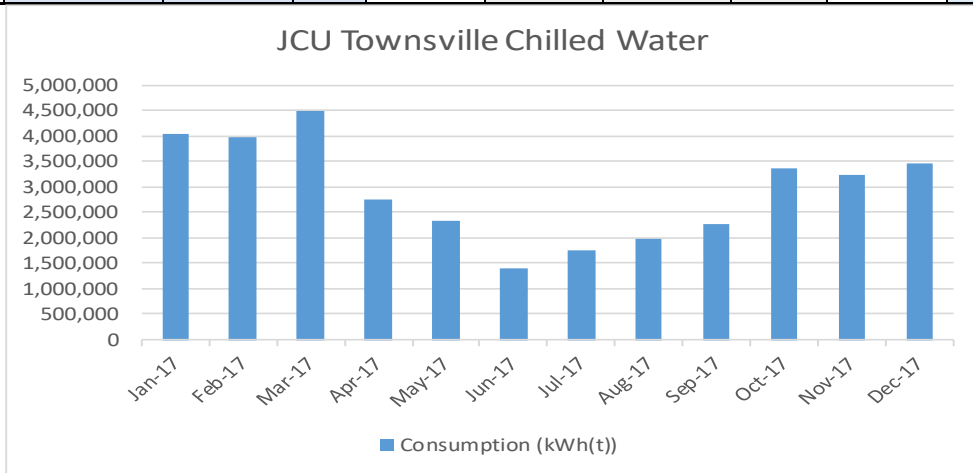

**Figure 9. Energy Consumption per month in 2017.**

**Table 10. Additional information on University Campus in Townsville.**

<b>Building mix in the area*:</b>	Non-residential, teaching/research/offices
<b>Consumer mix in the area**:</b>	Large, power consumed is 34GWh/a
<b>Energy plant owner (public or private):</b>	Private
<b>Thermal energy supply technologies***:</b>	Grid electricity
<b>Thermal energy production from solar:</b>	Insignificant PV solar contribution (55 kW on site with a 2.5 MW nominal)
<b>Geothermal collectors:</b>	Nil
<b>Thermal energy storage:</b>	120MW
<b>Cooling energy used:</b>	35,157 MWh(t) per annum
<b>Available cooling power:</b>	147,168 MW(t) per annum
<b>Electrical energy consumption:</b>	6,285 [MWh/a] measured to generate this thermal power (e.g., from simulation, measurement)
<b>Voltage level:</b>	11,000 [V]
<b>N. of consumer substations [power]:</b>	50 substations on our network. Direct supply for High Voltage Chiller Motors. Two, 1,000 kVA transformers for LV equipment[-]
<b>Local electric power supply technologies:</b>	Nil
<b>Backup power, critical demand:</b>	0 [MW] (what for)

### 6.1.2.1 Innovation in the Solution

Our solution is innovative in:

- Moving away from separate, standalone, chiller plants per each building
- Moving away from another high voltage 3MW capacity feeder – or additional power capacity, consumption, and demand
- Moving to a centralized system that includes the largest TEST in the southern hemisphere at 12 Mliter capacity
- Leading edge technology in the size of the installed chilling equipment for an off-demand installation.

### 6.1.3 Decision and Design Process

#### 6.1.3.1 General/Organizational Issues

- Why was this project initiated, to answer which need?
- The project avoided installing an additional electrical feeder, replacing several standalone chiller plants and paying higher bills for power consumption to facilitate planned campus growth.
- Which stakeholders were involved in the project?
- James Cook University staff and students, Ergon Energy, McClintock Engineering Group
- Which resources were available before the project? What are local energy potentials?
- Electrical power at 11kV potential.
- Who (what) were drivers and who (what) were opponents (barriers) – and why?
- Drivers were operating and replacement capital expenditure avoidance. Barriers were overcoming concerns about system scale and implementing new technologies at that scale.
- What have been the main challenges regarding decision finding?
- Decision-making? The main challenge is lining up all the required internal and external approvals and ensuring all documentation is completed as required for these meetings.
- What was finally the crucial parameter for go /no-go decision?

- Financial business case accuracy around forecast electrical power prices.

### 6.1.3.2 Financing Issues

- What have been the main challenges/constraints regarding financing?
- None, as the project financing was mostly internal and involved the State Treasury as the external body.

### 6.1.3.3 Technical Issues

- What have been major technical challenges/constraints regarding system design?
- Understanding the correct scale of the system and achieving a balance of chiller and TEST capacities.
- What solutions have been considered for generation, storage and load management?
- On-demand, a second similar sized Child Development Center (CDC) with Thermal Energy Storage and a larger CDC with Thermal Energy Storage were considered.

### 6.1.3.4 Design Approach

- Which tools have been used during the design phase? Include name, originate (plus web link), purpose of the tool, specific use of the tool within the case study, practical experiences during application, cost/price (if commercial tool)
- CAD software for design and excel files developed specifically for the project to model use and calculate business cases.
- What have been the main challenges in the design phase?
- Matching the chillers, systems and TEST capacities.
- What have been the most crucial interfaces?
- Interfacing the existing building chilled-water systems with the new central system chilled water and ensuring cross-contamination is reduced.
- What parameters are controlled via monitoring?
- Chiller run time schedules to ensure campus maximum demand limits are not breached. Flows, pressures, etc. as the parameters in the automated control system.

### 6.1.4 Resilience

Which threats were considered and are to be considered? Are there redundancies in the energy supply system?

- There are electrical power redundancies in that there are three high voltage feeders supplying the campus, but all feeders originate from the same Zone substation.
- There is no thermal power redundancy for the central energy plant, however n+1 redundancy has been designed into the system for major equipment..
- During cyclones, or similar events, the campus is closed with no staff or students in CDC cooled facilities and while there is capacity in the TEST, the chillers are not run to generate additional coolth. Post event, there are teams of recovery specialists who will give the all-clear and allow start-up of the electrical and thermal power systems.

What is the degree of autarky?

- This has not been quantified



## 6.1.5 Lessons Learned

### 6.1.5.1 Major Success Factors

Reduced electrical consumption and demand that benefited JCU and Ergon Energy

### 6.1.5.2 Major Bottlenecks

TEST capacity on high demand days



### 6.1.5.3 Major Lessons Learned

Ensuring that the centralized centrifugal chillers are run highly loaded, for as long continuous periods as possible and do not surge. Structural design parameters for the modular tank and not to use sandwiched panels in the construction.

What should be transferred from this projects?

*The huge benefits of reduced power consumptions, costs, and carbon equivalents that can be raised from a centralized plant.*

## 6.2 James Cook University Cairns Campus District Cooling System with Thermal Energy Storage, Australia

Case No.	Country	Location	Specific Type	Photo	Special points of attention
2	Australia	Cairns	Campus University		  district cooling, cold storage
<b>Country:</b> Australia <b>Name of city/municipality/public community:</b> Cairns, Queensland <b>Title of case study:</b> James Cook University Cairns Campus District Cooling System with Thermal Energy Storage <b>Author name(s):</b> Behzad Rismanchi/Caroline Frauenstein <a href="mailto:brismanchi@unimelb.edu.au">brismanchi@unimelb.edu.au</a> / <a href="mailto:caroline.frauenstein@jcu.edu.au">caroline.frauenstein@jcu.edu.au</a>				<b>Link(s) to further project related information/publications, etc.:</b> <a href="https://www.jcu.edu.au/tropical-sustainable-design-case-studies/by-building-type/all/case-study-campus-district-cooling-system-with-large-scale-thermal-energy-water-storage-james-cook-university-cairns-campus">https://www.jcu.edu.au/tropical-sustainable-design-case-studies/by-building-type/all/case-study-campus-district-cooling-system-with-large-scale-thermal-energy-water-storage-james-cook-university-cairns-campus</a>	



**Figure 10. University Campus in Cairns; Chilled-water reticulation.**

### **6.2.1 Background and Framework**

When JCU's Cairns Campus in tropical Far North Queensland, Australia, was constructed in 1994, the initial building's air-conditioning was serviced from a central plantroom containing three chillers and supplemented with a 3 Megaliter Thermal Energy Storage System (TESS) in 2005 to increase campus cooling capacity.

By 2010, we had reached a point where our electrical and air-conditioning demand for the campus had increased, through additional facilities, to a point where the existing infrastructure could no longer provide sufficient coolth for any future campus developments.

After the Townsville Campus District Cooling System project was successfully commissioned, we started actively scoping the new Cairns Campus District Cooling System (Figure 10) with Thermal Energy Storage and commissioned this project in 2012.

Interesting 2010 Statistics and Plans:

- 60 hectares containing nine distributed teaching and research facilities or 25,000 m<sup>2</sup> of air-conditioned space.
- Campus electrical maximum demand of 1.2MW.
- Power costs of \$0.7 million per annum.
- Development plans to add 29,000 m<sup>2</sup> of air-conditioned space by 2018 equating to 3.4MW electrical demand in a BAU scenario.

Solution:

We replaced the existing centralized chiller and TEST facility with a new facility, capable of servicing the projected campus growth for the next 15 years, increased the amount of in-

ground chilled-water piping providing off-takes for future developments and planned a second electrical feeder from a different Zone substation for the campus.

Our business case compared this larger scale sustainable, energy reduction opportunity with the alternative of installing either standalone chillers for each new building – or constructing a second, similar sized central chiller and TESS facility.

The system continued to run the chillers during periods of low campus load - in the night when the lighting and power loads are lower – to charge the TESS, which then provided the cooling during the high demand lighting and power campus loads, typically between 08:00 and 17:00.

Interesting Project Statistics and Information:

- 9 Megaliter, modular, baseplate and galvanized steel plate, TESS stands 16.5 m high and has an outside diameter of 28 m. Maintaining a thermocline and distinct stratification is critical. Insulation is provided by 150 mm layer of polyurethane insulation and the water seal by a 1.5 mm welded butyl rubber liner. Nominal capacity is 90,000 MWh(t).
- The system has 5.8 kilometers of reticulated piping (DN450 to DN110), is open to atmosphere and therefore treated with a molybdate corrosion inhibitor and various biocides and treatment additives. CHW is typically sent to the campus at 6 °C and returned to the TESS higher than 12 °C.
- Two, 4.2MW(t) rated Trane CVHG Chillers and a single 3MW(t) Trane CVHG Chiller provide the system chilling capacity in the central energy plant. Primary CHW Pumps service the chillers while Secondary CHW Pumps provide the pressure to reticulate the CHW around the campus with Tertiary CHW Pumps located in each building.
- A Condensed Water system uses eight, induced draft counter flow evaporative coolers to each cool 100 liters/second of water from 37 °C to 31 °C with an air entering wet bulb temperature of 27 °C.

### 6.2.2 Energy Objectives

- Reduce Maximum Demand from 3.4MW to 2.5MW in 2020 with 54,000 m<sup>2</sup> air-conditioned space.
- Reduce electrical operating costs by 25%.

Current Status:

Five and a half years after implementation, all objectives are on track to be achieved or exceeded, especially as the built programme has been accelerated and 54,000 m<sup>2</sup> is currently air-conditioned, with a further 4,000 m<sup>2</sup> to be added in 2019.

Interesting Statistics (see Table 11 and 12):

- Achieved 2017 campus electrical maximum demand of 1.7MW with 54,000 m<sup>2</sup> air-conditioned space
- 2017 power costs reduced by 29% against BAU
- Maximum 2017, 24-hour consumption of 58MW(t) (Figure 11).

**Table 11. Quantitative Information on University Campus in Cairns case.**

	Urban scale of area [m <sup>2</sup> ]	Total gross floor area [m <sup>2</sup> ]	Heated floor area [m <sup>2</sup> ]	Population/Users in the area	Supply/return T [°C]	Thermal energy storage volume [m <sup>3</sup> ]	Cooling energy demand [MWh/a]	Electrical energy demand	Annual electric energy yield [MWh/a]
Before	600000	29000	0	4415	9/17	0		1.2	
BAU	600000	54000	0		6/14	0		3.4	
After	600000	54000	0	3301	6/12	9000	11533.8	1.6	2647.2

**Table 12. Additional Information on case University Campus in Cairns, Australia.**

Building mix in the area*:	Non-residential, teaching/research/offices
Consumer mix in the area**:	Large, power consumed is 8.4GWh/a
Energy plant owner (public or private):	Private
Thermal energy supply technologies***:	Grid electricity
Thermal energy production from solar:	Nil
Geothermal collectors:	Nil
Thermal energy storage:	90MW
Investment costs****:	[All per m <sup>2</sup> of usable area 'm <sub>ua</sub> '.]
Cooling energy used:	11,533 MWh(t) per annum
Available cooling power:	100,000 MW(t) per annum
Electrical energy consumption:	2,647 [MWh/a]
Voltage level:	22,000 [V]
N. of consumer substations [power]:	16 substations on our network. Supply for the Low Voltage equipment in the Central Energy Plant is via four 1,500 kVA and one, 1,000 kVA transformers [-]
Electric power supply technologies:	Nil
Backup power, critical demand :	0 [MW] (what for)

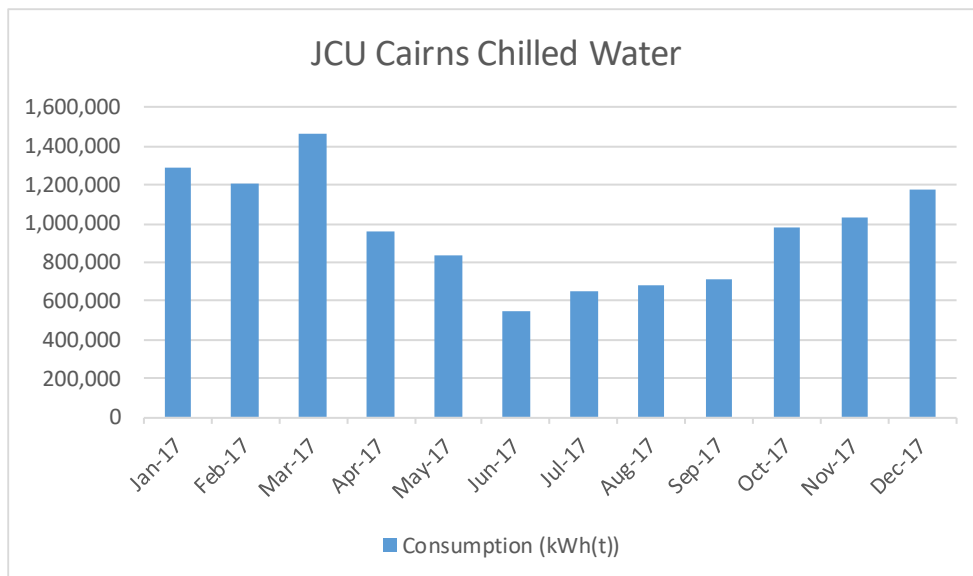

**Figure 11. Cairns thermal energy for chilled-water consumption.**

## 6.2.3 Decision and Design Process

### 6.2.3.1 General/Organizational Issues

Describe a technical or organizational highlight:

- Our solution is not innovative for this campus given the previous installation history, and the size of the campus installation in Townsville. However, it is still innovative in industry.
- Why was this project initiated, to answer which need?
- The project facilitated planned campus growth.
- Which stakeholders were involved in the project?
- James Cook University staff and students, Ergon Energy, McClintock Engineering Group
- Which resources were available before the project? What are local energy potentials?
- Electrical power at 22kV potential.
- Who (what) were drivers and who (what) were opponents (barriers) – and why?
- Drivers were operating and replacement capital expenditure avoidance. Barriers were reducing capital expenditure.
- What have been the main challenges regarding decision finding?
- Decision-making? The main challenge is lining up all the required internal and external approvals and ensuring all documentation is completed as required for these meetings.
- What was finally the crucial parameter for go /no-go decision?
- Financial business case accuracy around forecast electrical power prices.

### 6.2.3.2 Financing Issues

What have been the main challenges/constraints regarding financing?

*None as the project financing was mostly internal and involved the State Treasury as the external body.*

### 6.2.3.3 Technical Issues

What have been major technical challenges/constraints regarding system design?

*Understanding the correct scale of the system and achieving a balance of chiller and TESS capacities.*

What solutions have been considered for generation, storage, and load management?

*On-demand and Thermal Energy Storage systems were considered.*

### 6.2.3.4 Design Approach

Which tools have been used during the design phase? Include name, originate (plus web link), purpose of the tool, specific use of the tool within the case study, practical experiences during application, cost/price (if commercial tool).

*CAD software for design and excel files developed specifically for the project to model use and calculate business cases.*

What have been the main challenges in the design phase?

*Matching the chillers, systems and TEST capacities.*

What have been the most crucial interfaces?

*Interfacing the existing building air-conditioning mechanical and control systems with the new central system software platforms.*

What parameters are controlled via monitoring?

*Chiller run time schedules to ensure campus maximum demand limits are not breached. Flows, pressures, etc. as the parameters in the automated control system.*

### 6.2.4 Resilience

Which threats were considered and are to be considered? Are there redundancies in the energy supply system?

*There are electrical power redundancies in that there are two separate high voltage feeders supplying the campus currently from the same Zone substation, but with plans to separate the supplies in future.*

*There is no thermal power redundancy for the central energy plant, however n+1 redundancy has been designed into the system for major equipment.*

*During cyclones, or similar events, the campus is closed with no staff or students in CDC cooled facilities and while there is capacity in the TESS, the chillers are not run to generate additional coolth. Post event, there are teams of recovery specialists who will give the all-clear and allow start-up of the electrical and thermal power systems.*

What is the degree of autarky?

*This has not been quantified*

## 6.2.5 Lessons Learned

### 6.2.5.1 Major Success Factors

Reduced electrical consumption and demand, which benefited JCU and Ergon Energy.

### 6.2.5.2 Major Bottlenecks

None.



### 6.2.5.3 Major Lessons Learned

Design of manholes on the modular tank.

What should be transferred from this project?

*The huge benefits of reduced power consumptions, costs and carbon equivalents that can be raised from a centralized plant.*

## 6.3 University of Innsbruck – Technology Campus. Renovation of Two Buildings and Their Auxiliary Buildings, Austria

Case No.	Country	Location	Specific Type	Photo	Special points of attention
3	Austria	Innsbruck	Campus University		  building efficiency, ambient cold

Country:	Austria
Name of city/municipality/public community:	Innsbruck
Title of case study:	University of Innsbruck – Technology Campus. Renovation of two buildings and their auxiliary buildings (Architecture, technical sciences)
Author name(s):	Anna M. Fulterer AEE INTEC, Dirk Jäger BIG
Author email(s):	a.m.fulterer@aee.at
Team of the scientific project for renovation of main building;	e7 energy market analysis; BIG; Grazer energy agent; Passivehaus Innsbruck; ATP Engineers
Link(s) to further project related information / publications, etc.:	<p><a href="http://www.big.at/projekte/fakultaet-fuer-architektur/">http://www.big.at/projekte/fakultaet-fuer-architektur/</a></p> <p><a href="http://www.big.at/projekte/fakultaet-fuer-technische-wissenschaften/">http://www.big.at/projekte/fakultaet-fuer-technische-wissenschaften/</a></p> <p><a href="https://www.nextroom.at/building.php?id=37298">https://www.nextroom.at/building.php?id=37298</a></p> <p><a href="https://nachhaltigwirtschaften.at/de/hdz/projekte/bigmodern-subprojekt-9-demonstrationsprojekt-universitaet-innsbruck-fakultaet-fuer-bauingenieurwesen-bauliche-umsetzung.php">https://nachhaltigwirtschaften.at/de/hdz/projekte/bigmodern-subprojekt-9-demonstrationsprojekt-universitaet-innsbruck-fakultaet-fuer-bauingenieurwesen-bauliche-umsetzung.php</a></p> <p><a href="https://www.monitoringstelle.at/index.php?id=752&amp;tx_ttnews%5Btt_news%5D=1019&amp;cHash=ad1ba45454f3f95f0c09690fc56e9e9c">https://www.monitoringstelle.at/index.php?id=752&amp;tx_ttnews%5Btt_news%5D=1019&amp;cHash=ad1ba45454f3f95f0c09690fc56e9e9c</a></p> <p><a href="https://www.cci-dialog.de/wissensportal/projekte/sonstiges/sanierung_fakultaeten_architektur_und_technische_wissenschaften_der_uni_innsbruck.html?backLink=/wissensportal/projekte/sonstiges/sanierung_fakultaeten_architektur_und_technische_wissenschaften_der_uni_innsbruck.html">https://www.cci-dialog.de/wissensportal/projekte/sonstiges/sanierung_fakultaeten_architektur_und_technische_wissenschaften_der_uni_innsbruck.html?backLink=/wissensportal/projekte/sonstiges/sanierung_fakultaeten_architektur_und_technische_wissenschaften_der_uni_innsbruck.html</a></p> <p><a href="https://nachhaltigwirtschaften.at/de/hdz/projekte/bigmodern-nachhaltige-modernisierungsstandards-fuer-bundesgebaeude-der-bauperiode-der-50er-bis-80er-jahre.php">https://nachhaltigwirtschaften.at/de/hdz/projekte/bigmodern-nachhaltige-modernisierungsstandards-fuer-bundesgebaeude-der-bauperiode-der-50er-bis-80er-jahre.php</a></p> <p><a href="https://nachhaltigwirtschaften.at/resources/hdz_pdf/events/20091009_hdz_workshop_big_jaeger.pdf?m=1469660299">https://nachhaltigwirtschaften.at/resources/hdz_pdf/events/20091009_hdz_workshop_big_jaeger.pdf?m=1469660299</a></p> <p><a href="https://www.atp.ag/integrale-planung/service/news/archiv/news-archiv/campus-technik/">https://www.atp.ag/integrale-planung/service/news/archiv/news-archiv/campus-technik/</a></p> <p><a href="http://www.westwind.or.at/fileadmin/pdf/WW_2016_A3_Online.pdf">http://www.westwind.or.at/fileadmin/pdf/WW_2016_A3_Online.pdf</a></p>
Sources:	
BIGMODERN Leitprojekt: Nachhaltige Sanierungsstandards für Bundesgebäude der Bauperiode der 50er bis 80er Jahre	
BIGMODERN Subprojekt 3: Demonstrationsgebäude Universität Innsbruck - Hauptgebäude der Fakultät für technische Wissenschaften. Planungsprozess. ; D. Jäger, G. Hofer, K. Leutgöb, M. Grim, C. Kuh, G. Bucar. Berichte aus Energie- und Umweltforschung 15/2013	
BIGMODERN Subprojekt 9: Demonstrationsgebäude Universität Innsbruck – Umsetzung. Schriftenreihe 30/2015 D. Jäger, K. Leutgöb, G. Bucar, Herausgeber: BMVIT	
And the project descriptions to be found following the links above.	



### 6.3.1 Background and Framework

The objective of the case study was to undertake the renovation process (01/2013-04/2016) of two buildings that are part of an ensemble that forms the technology campus of the University of Innsbruck (Figures 12 and 13). The buildings are owned by BIG, one of the largest public building owners in Austria. BIG constructs, maintains and renovates buildings that are let to universities, schools and public administration, and now holds 7.2 Mio. m<sup>2</sup>. BIG has know-how on renovation and technical issues, but is limited in budget since all renovations have to be financed by rental income, and thus by financial means of the tenants.

**Function and surroundings:** The two 4- and 8-story-buildings and their auxiliary buildings are located on the technology campus of the University of Innsbruck. They hold mostly offices, seminar rooms, and laboratory rooms. Both buildings were constructed late in the 1960s in a modular way. At that time, the campus was located on the edge of the town. Since then, the town closed in around the campus; there is however a master plan for the campus to expand to the west, where there are still areas available. Innsbruck's moderate climate with partly alpine character poses the challenge of cold and dry winter and hot summer. See Tables 13 and 14 for additional quantitative information.

**Energy supply:** The area is supplied by a local district heating fed by natural gas, with generation directly on the university campus as established in the 1960s. The system is not connected to public district heating, but it serves additional buildings outside of the university, like a school. Energy generation costs for district heat are typically 0.06 € in Austria for heat and the large clients tariff ranges from 0.08 to 0.12 € per kWh. Local primary energy factors are 1.3 for the district heating and 1.91 for the Austrian power mix (Österreichisches Institut für Bautechnik [Austrian Institute for Structural Engineering] [OIB] Guidelines 2015). Heat is provided at high temperature (typically 80/50), with temperature lowered locally where possible. A change of fuel or lowering of feed and return temperature for the overall system was not considered in the project. Power is provided by the public power grid, with UPS units located onsite for backup. The energy system is not owned by BIG but by the university (tenant of buildings) itself.

**Local energy resources:** Use of solar energy has been considered but abandoned due to lack of suitable surfaces. The energy topics addressed with most priority were ventilation and cooling since overheating was one of the most urgent problems before renovation. As a result, a ground water well is used for cooling on building level, while ventilation is addressed by a combination of automated window control and central ventilation system.

The renovation of the 8-story building was planned in the subsidized R&D project "BIGMODERN." The following sections mostly refer to this demonstration building process.

**Project objectives and challenges:** The project objective was to bring the buildings to an up-to-date standard regarding energy consumption, building services, comfort, and safety. Moreover, an important objective in the R&D project was to develop an enhanced standard building process to be further used in other projects at BIG, leading to innovative energy-efficient solutions at standard cost level.



Figure 12. View on the campus of the University of Technology Innsbruck. The marked buildings have been renovated in the described process (Source: [basemap.at](http://basemap.at) 2020).

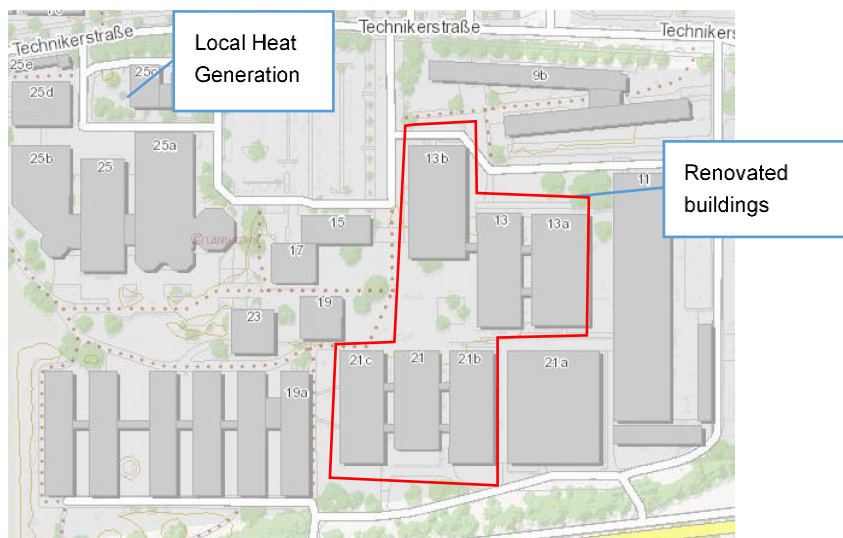

Figure 13. Map of the campus area. Source: Tiris - Tiroler Rauminformationssystem © DKM. BEV-Wien ©TIRIS, with additional Information on renovated buildings and location of heat generation (2018)

**Innovative ideas:** The main organizational innovation is integrative planning. Using this approach, the following technical innovations could be realized:

Integration of balconies, which formerly comprised heat bridges, into the building envelope. Natural ventilation through exterior windows and “overflow-doors/windows.” Heat from ventilation is recovered.

Windows, sun shading, and lighting are controlled by an innovative control system. Window openings and night flushing are automated by the building technology system. Light shelves are used to get daylight far into the building. A new facade system has been especially designed for the project.

### 6.3.2 Energy Objectives

- Reduce the energy consumption for heating and HVAC to a value at or below the threshold for nearly zero energy buildings in Austria (Figures 14-16).
- Use locally available natural resources.
- Ensure a redundant supply of critical data server infrastructure.
- Planners were confronted by BIG with the statement: “BIG sets highest value on energy efficiency.”

Table 13. Quantitative Information on case of University campus in Innsbruck.

	Urban scale of area [m <sup>2</sup> ]	Heated floor area [m <sup>2</sup> ] (8-story building)	Population/Users in the area	Thermal energy demand [MWh/a]	Network heat losses [%]	Number of producer substations: heat	Supply/return T [°C]	Annual cold yield from local sources [MWh]	Cooling energy demand [MWh/a]	Total energy consumption [kWh/m <sup>2</sup> a]-
Before	~18.000	11.800		80 kWh/m <sup>2</sup> a 10.000 MWh	unknown	1	75/60 °C			76 (2.6 GWh/a)
BAU		11.800		28	Local reduction	1	75/60 °C	0		
After	~18.000	12.800	700+	13,85	Local reduction	2	Locally reduced	290 MWh	360 MWh	30 (0.9 GWh/a)

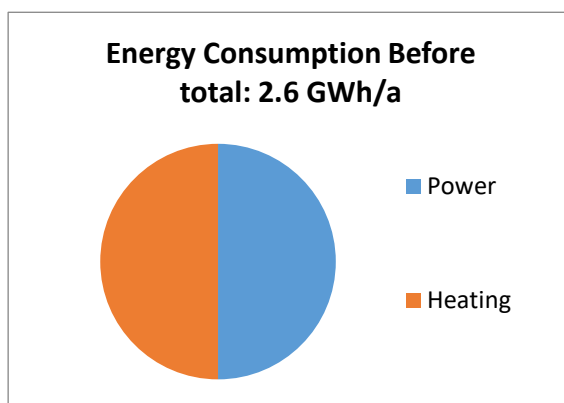
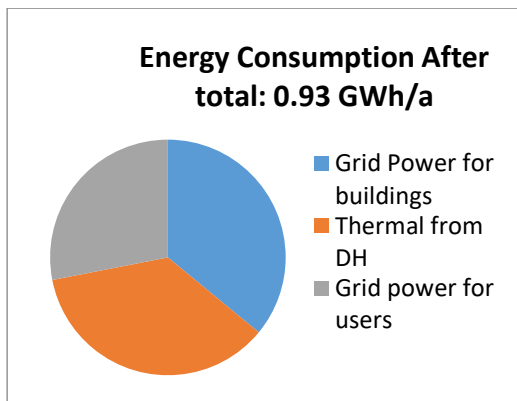
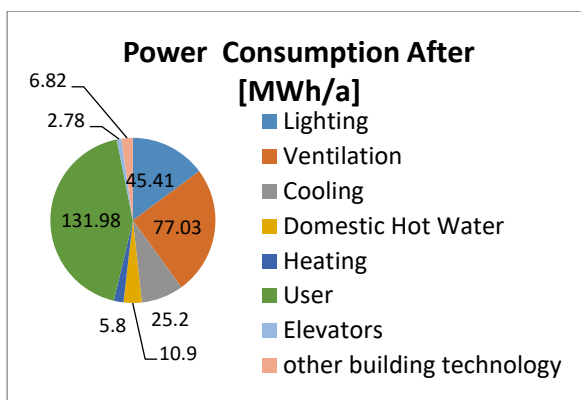

Figure 14. Energy Consumption before modernization.



**Figure 15. Energy Consumption after modernization.**



**Figure 16. Energy consumption per use type after modernization.**

**Table 14. Additional Information on case of University Campus Technik in Innsbruck, Austria.**

Building mix in the area*:	100% educational: offices, labs, seminar rooms
Consumer mix in the area**:	100% large consumers
Energy plant owner (public or private):	University (tenant of buildings)
Thermal energy supply technologies***:	district heating using natural gas
Thermal energy production from solar:	—
Geothermal collectors:	~8*36,200 MWh/a cooling energy from ground water well at 14/18 °C
Investment costs****:	[All per m <sup>2</sup> of 'm <sub>ua</sub> '.] Total cost:37 Mio
Cooling energy used:	10.9 kWh/m <sup>2</sup> .a (demonstration building)
Electrical energy demand:	590 [MWh/a] (monitoring first year); 46 kWh/m <sup>2</sup> a
Voltage level:	10 kV [V]
Electric power supply technologies:	Installation of PV is planned for the future
Annual electric energy yield:	none
Backup power, critical demand:	A diesel fed UPS unit (typically 2500 VA) was installed in the refurbishment project for emergency ventilation and lighting

### 6.3.3 Innovative Approach

The main innovative approach in this project was the integrated planning with an upper limit for investment costs and the LCCA, and an early assessment of alternative solution sets. The planning was done by a team consisting of members of the (responsible) planning company (architecture, HVAC, Electric, Statics) and an engineering office for building physics. Two additional (research) institutions supervised the thermo-energetical optimization, conducted LCC calculations and checked the detailed planning. Two different teams conducted building

energy simulations and cross checked their results. The owner (BIG) was responsible for the project controlling.

The main technical innovation was to use a control system (Figure 17) for natural ventilation by windows, and let the air move via custom build sound absorbing overflow windows/doors into the common spaces. Inner rooms are served by the existing central ventilation system. Heat from exhaust air is recovered to incoming air. To allow for ventilation, exterior “top-hung projecting windows” have been custom designed and build to achieve optimal performance (Figure 18).

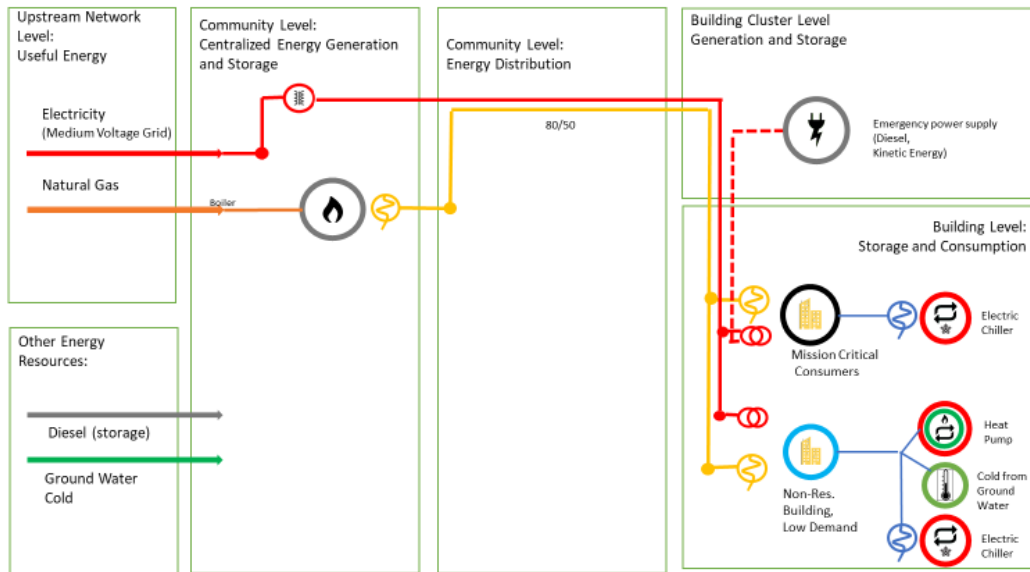

Figure 17. Energy system of Campus Technik in Innsbruck (Source: AEE INTEC).

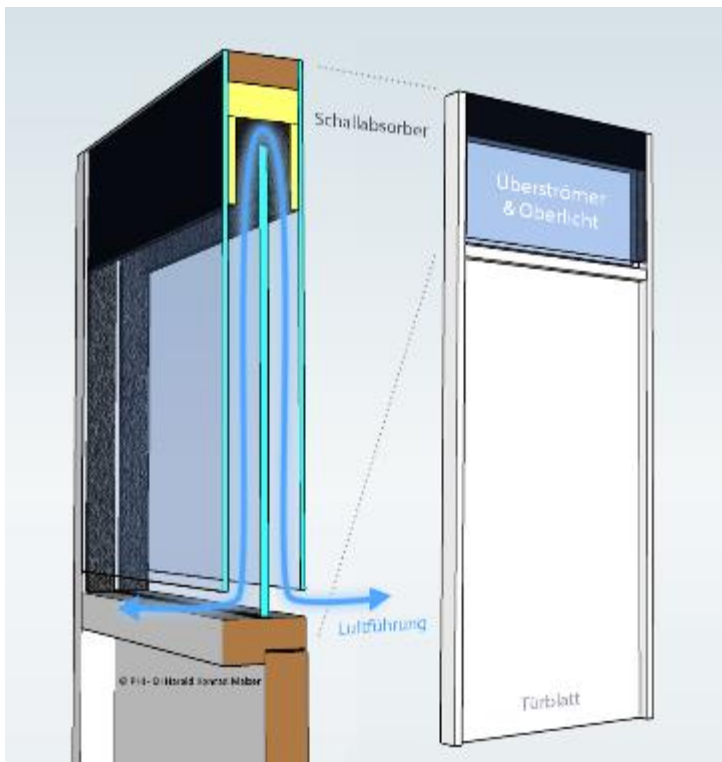

Figure 18. Overflow opening in the door/window (Source: PHI – DI Harald Konrad Malzer).

## 6.3.4 Decision and Design Process

### 6.3.4.1 General/Organizational Issues

Why was this project initiated, to answer which need?

*The project was initiated by the building user and the building owner, who saw a need for modernization due to low comfort and worn out building components. The University of Innsbruck has a focus on sustainability and energy efficiency, and that was an additional reason for aiming at a high standard.*

Which stakeholders were involved in the project?

*The involved parties were users (University of Innsbruck), owner (BIG), planning office (ATP), research institutes (passive-house institutes, e7 energy market analysis, Graz Energy Agency, additional subplanners (see Figure 19).*

Which resources were available before the project? What are local energy potentials?

*Local energy potentials are local district heating, cool night air for cooling, high solar irradiance. Available resources include building frames of high quality and useful structure, financial support for pilot project, planning team experienced in integral planning.*

Who (what) were drivers and who (what) were opponents (barriers) – and why?

*The main driver for the process was the need of BIG to try if integrated planning enables a renovation with limited budget, using innovative measures to reach high quality. Once additional subsidies from a programme supporting research were secured, it was clear that the renovation would take place. The main barrier for the process was the limited budget available to tackle the need for reliable high-quality solution.*

What have been the main challenges regarding decision finding?

*One important challenge was to respect the needs of both user (university) and owner (BIG), to keep costs below the given threshold but still realize a solution that fit the needs of users. Another challenge was to find a technical solution for ventilation within the given boundary conditions (high demand, hot summer, dry air in winter, existing ventilation plant and available space for central system).*

What was finally the crucial parameter for go /no-go decision?

*The renovation would have been done anyway, aiming at a better than BAU energy target, due to both BIG and tenant (University).*

*Additional measures were realized if they were economically advantageous or could be financed via support for innovative action. The additional subsidies allowed for a better design of the process, LCC calculation and a more innovative solution due to integral planning. Moreover, an extended monitoring period allowed to optimize the complex energy system. One important point for BIG was that results and experience from this project could be exploited in the following projects.*

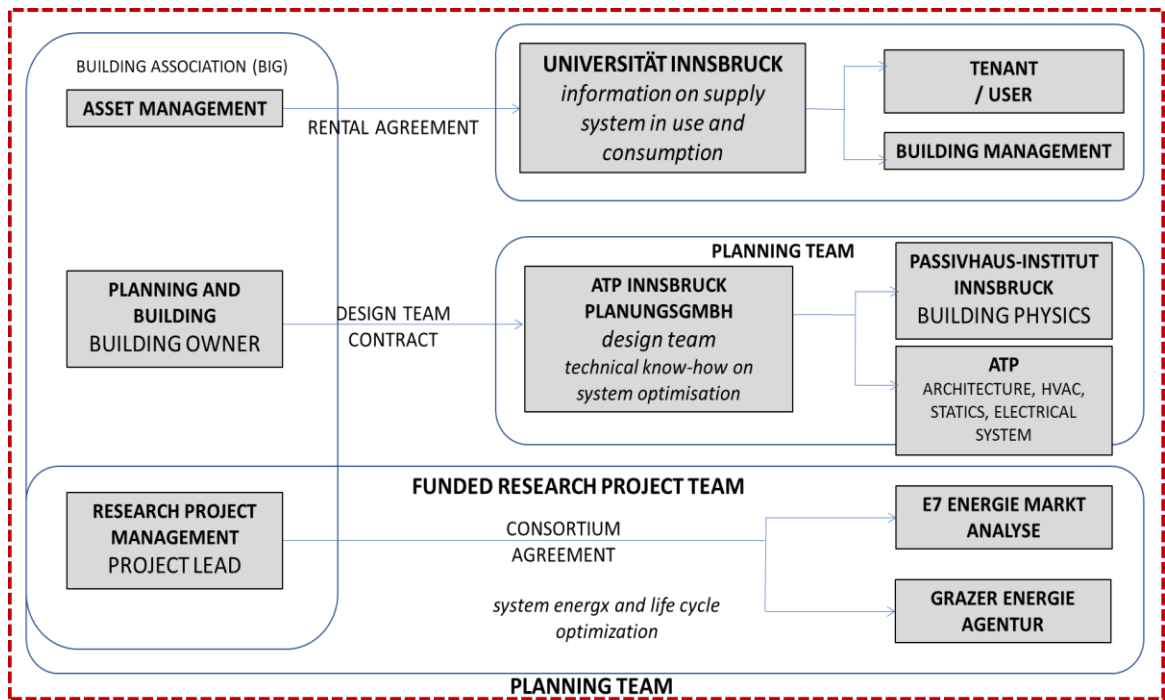

**Figure 19. Stakeholder structure in Planning Process. Input necessary for whole system resilience analysis is highlighted in italic. Own presentation of data from BIGMODERN project, translated and details added.**

### 6.3.4.2 Financing Issues

What have been the main challenges/constraints regarding financing?

- The investment costs were limited since they have to be covered by the tenant (here the University of Innsbruck). On the other hand, life cycle costs are usually neglected. In his project one aim was to consider life cycle costs as well as investment costs.

Which business model applies to the project?

- The renovation process is financed by the building owner, and subsidized by public funds for R&D. The tenant on the long term pays back the investment by paying a higher rent. This is hopefully compensated by lower energy and maintenance costs (also covered by tenant).

### 6.3.4.3 Design Approach Applied

Which design targets have been set and why?

Additional design targets for innovative actions:

- Life cycle cost calculations
- Integral planning and analysis of alternatives
- Consideration of maintenance etc.

Technical:

- Air tightness ( $n_{50} < 1$ )
- Thermal bridges ( $\leq 0.05 \text{ W/m}^2\text{K}$ )

- Heating demand < 25 kWh/m<sup>2</sup>a; cooling demand <0.8 kWh/m<sup>2</sup>a (energy performance certificate), primary energy demand < 150 kWh/m<sup>2</sup>a (additional calculation, e.g., PHPP, TQB factors)

Comfort:

- Light: check possibility for light guiding systems
- Light: homogeneous artificial light density at work places (lighting concept, simulation)
- Light: Natural light and sight to outside (optimize by simulation)
- Sun shading and glare protection (to be regulated by users, allow intervisibility)
- Thermal comfort in winter and summer (air-wall:  $\Delta T < 4K$ , air – window  $\Delta T < 6K$ , < 5% h overheating (ÖNORM EN 15251))
- Air: natural ventilation possible for >60% of area
- Acoustics: reverberation time according to local standard ÖNORM B 8115-3

Which decision steps/workflow lead to the retained solution?

1. *Decision for an integral planning process (integrating also monitoring concept): integral design – bid – build*
2. *Definition of targets for planners (see above) + maximum costs*
3. *Definition of BAU planning process & possible additional measures to reach higher standard*
4. *Energetical and economical check of the outcome of the BAU and the effect of additional measures, using various tools, optimization*
5. *Decision on which measure set was to be implemented in addition to BAU measures, weighting summer comfort against investment and LC costs*
6. *Bid for construction works:*
7. *Evaluation/monitoring to fix problems*

### 6.3.4.4 Technical Issues

What have been major technical challenges/constraints regarding system design?

*Compact buildings with deep rooms, need for daylight and ventilation solutions that still maintain indoor temperatures on an acceptable level, even though thermal mass is limited.*

What solutions have been considered for generation, storage and load management?

*The focus was on energy efficiency for HVAC, and passive night ventilation for cooling. Heat is provided by a nearby (200 m) district heating production unit, electric energy by the grid. Possibility of PV on roof was checked. Use of groundwater well for cooling was considered and realized.*

Which tools have been used during the design phase? Include name, originate (plus web link), purpose of the tool, specific use of the tool within the case study, practical experiences during application, cost/price (if commercial tool).

1. *Energy performance certificate according to ÖNORM*
2. *PHPP ([https://passiv.de/de/04\\_phpp/04\\_phpp.htm](https://passiv.de/de/04_phpp/04_phpp.htm))*
3. *Dynamical building simulation*
4. *Daylight simulation*
5. *Certification tool (PHphit)*
6. *Life cycle costs*
7. *Development of a tool for BIG :*
8. *Decision-making*
9. *Efficiency criteria.*



What have been the main challenges in the design phase?

*Bringing as much daylight as possible into the building without increasing overheating risk, as well as natural ventilation of 60% of areas. These two requirements led to the very innovative solutions.*

What have been the most crucial interfaces?

*Planning team <-> owner (controlling of finances) and teams that check sustainability targets.*

What parameters are controlled via monitoring?

*Heat and power consumption of each building, ground water well cold production, total power for water pumps needed for heating, heat consumption in different heating circuits, cold distribution, power for cold distribution, power/heat/cold for ventilation, power for lighting and user per level, power for lift, laboratory, water, emergency power per building.*

### **6.3.5 Resilience**

Resilience was targeted by installation of an uninterruptible power supply unit. One important issue is that in this case the district heating system and buildings are not owned by the same entity, a factor that represented a challenge to the project team.

Which threats were considered and are to be considered? Are there redundancies in the energy supply system?

*Some situations are considered for each public building process, like blackout of general power supply system, blackout of internal power supply due to fire. There is an emergency power supply to feed emergency lighting and emergency ventilation. Resilience to other dangers was not an important topic in the renovation process, and is not reported in the available reports on the project.*

What is the degree of autarky?

*Heat comes to 100% from local network fed by natural gas.*

Which processes that require heat, cooling or power are there? Which ones are critical? (Order by priority). What is the possible timeout without imposing damage?

- *Exhaust ventilation of laboratories*
- *Exhaust ventilation of access areas/staircases in case of fire*
- *Data center or server rooms (zero time out possible)*
- *Emergency lighting.*

Are there backup systems? On which time-scale can they be accessed?

- *1 UPS units for power backup has been installed*
- *For heat there is often the possibility to use another energy carrier in the boiler (like coal instead of biomass etc.)*
- *On the long term, there is the possibility to connect to the public district heating*
- *In addition to the heat distribution by water, it is possible to heat (and cool) by ventilation. Electric heat pumps can be used on medium time-scale for heating as well as for cooling.*

## 6.3.6 Lessons Learned

### 6.3.6.1 Major Success Factors

Both tenant and owner have know-how on building, and were interested in achieving a high-level results.

Acquisition of appropriate financial subsidies allowed for developing and keeping track of non-standard procedures (integral planning, innovative measures, monitoring, LCC).

### 6.3.6.2 Major Bottlenecks

No construction company would deliver the innovative prefabricated facade as it was planned, thus the design had to be adapted, including standard elements to achieve the aspired result.

Complex control system in one of the buildings requires the tenants' attention and know-how.



### 6.3.6.3 Major Lessons Learned

- Life cycle cost calculations show that low-tech solutions are have lower life cycle costs.
- Permanent monitoring and temporal monitoring do lead to similar costs.
- High-level criteria for energy efficiency and sustainability led to better than usual results, because they were defined early (should be before commissioning to planner team) and checked throughout the process. The same applies to costs.
- Integral planning, with the responsibility lying with the main planner (here ATP) allowed for good solutions.
- Optimization variants (e.g., regarding HVAC) should be defined and assessed in the preliminary phase.
- For innovative technologies one needs to define:
  - Technical requirements for feasibility
  - Critical factors like error-proneness of control systems, space requirements ...
  - Conditions for cost effectiveness and cost drivers
  - Criteria for the RFP.
- Important issues for the renovation of educational and offices buildings built in 50s to 80s:
  - Reduce heat losses from ventilation by high-efficiency ventilation with heat recovery.
  - Make optimal use of daylight, sun shading, energy-saving lighting.
  - Provide summer comfort and sustainable cooling.
  - Use innovative facade systems e.g., prefabrication for low impact on users.

What should be transferred from this project?

- *Use integral planning to enable innovative solutions.*
- *Define energy and cost limits in an early planning phase (preliminary design).*
- *Control life cycle costs and energy implications at decision points.*
- *Consider monitoring already in the planning phase.*
- *In case of complex technical installations involve the future operator from an early phase.*

## 6.4 WU Vienna, Austria

Case No.	Country	Location	Specific Type	Photo	Special points of attention
4	Austria	Vienna	Campus University		 <p>district cooling/heating, heat pump, groundwater thermal storage</p>
Country:				Austria	
Name of city/municipality/public community:				Vienna	
Title of case study:				University of Innsbruck – Technology Campus. Renovation of two buildings and their auxiliary buildings	
Author name(s):				Anna M. Fulterer, Maximilian Pammer, Peter Kern, Gert Widu	
Author email(s):				a.m.fulterer@aee.at	
Link(s) to further project related information / publications, etc.:				<a href="https://www.wu.ac.at/en/the-university/campus">https://www.wu.ac.at/en/the-university/campus</a>	
Book:				Boeckl, Matthias, ed. Der Campus der Wirtschaftsuniversität Wien. Vienna University of Economics and Business Campus: Stadt-Architektur-Nutzer. City-Architecture-User. Birkhäuser, 2014. Energy Performance Certificates of the buildings	
Further documentation of building services provided by BIG					

### 6.4.1 Background and Framework

The new university campus of the university of economy WU Vienna was put into operation in 2013 and houses all departments of the WU, which were formerly scattered around Vienna (Figures 20 and 21). The building complex is located in Leopoldstadt, Vienna, Austria. The main design target was to create a set of pavilions that host the WU university in a green garden as “walk along park,” open to the surrounding public and as sustainable as possible (ÖGNI standard). The new campus moreover was designed to allow for a more efficient and slim administration, by grouping institutes to departments.



**Figure 20. Overview of the University Campus of the Vienna University of Economics and Business (Source: basemap 2019)**

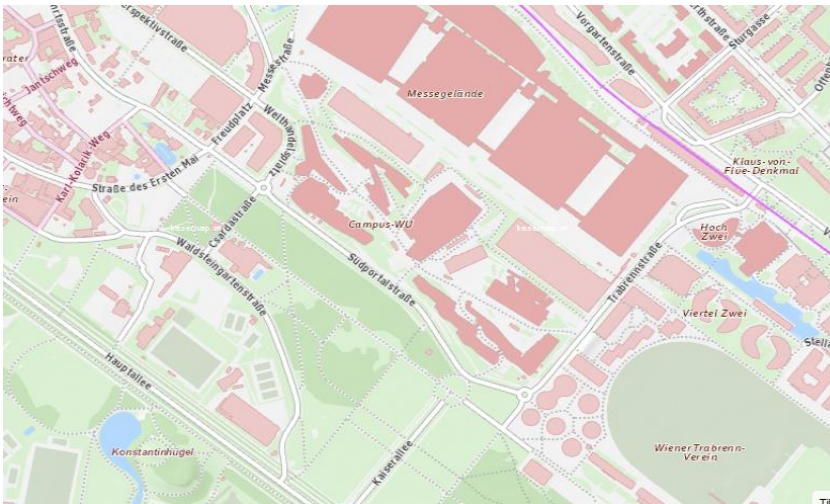

**Figure 21. Urban embedding of the WU Vienna, between a fair ground and the popular and well-known urban outdoor area “Wurstelprater,” with excellent public transport (Source: Openstreetmap ©Contributors to Openstreetmap).**

Users are the 23,000 students and 2,300 employees of the university of economy WU Vienna.

The area is served by the Austrian power grid (medium voltage) and district heat. Energy prices are about 10 €ct for 1 kWh for heat and power. Primary energy factors are 1.52 for district heating (mainly nonrenewable now in Vienna) and 1.91 for the Austrian power mix. About two-thirds of the energy for heat and cooling are obtained from groundwater seawater or river water, which flows with 140 l/sec through the area. To use this energy source, the water rights were obtained, and a small fee of around 2000€ is paid yearly to the company operating the nearby hydroelectric power station. Figures 22 and 23 show graphs of the energy supply and demand.

There are two heat distribution grids in use, one for high temperature heat, the other for low temperature heat. Low temperature heat is provided from ground water plus heat pump and from server cooling. Low temperature heat is used for normal space heating, this is possible due to low energy demand and core activation. High temperature heat is provided by district

heating network, and is used for some convectors, hot water, and entrance veils. See Tables 15 and 16 for additional quantitative information on the case of WU Campus.

### 6.4.2 Energy Objectives

- Low energy consumption
- Use of local sources (here the new ground water sea)
- Economically and Environmentally sustainable energy provision
- ÖGNI standard
- Reliable service of data servers
- Energy Performance Targets defined by the Austrian legislation.

Table 15. Quantitative Information on Case of WU Campus.

	Urban scale of area [m <sup>2</sup> ]	Total gross floor area [m <sup>2</sup> ]	Heated floor area [m <sup>2</sup> ]	Population/Users in the area	Thermal energy demand [MWh/a]	Network heat losses [%]	Number of producer	Supply/return T [°C] heat	Supply/return T [°C] cool	Thermal energy storage volume [m <sup>3</sup> ]	Annual heat yield from local sources [MWh/a]
After	9 ha	165.000	132.000	26.500	2164	Approx. 5%	3	80/50 55/35 45/30 30/28	14/19	5000 plus ground water sea	2/3

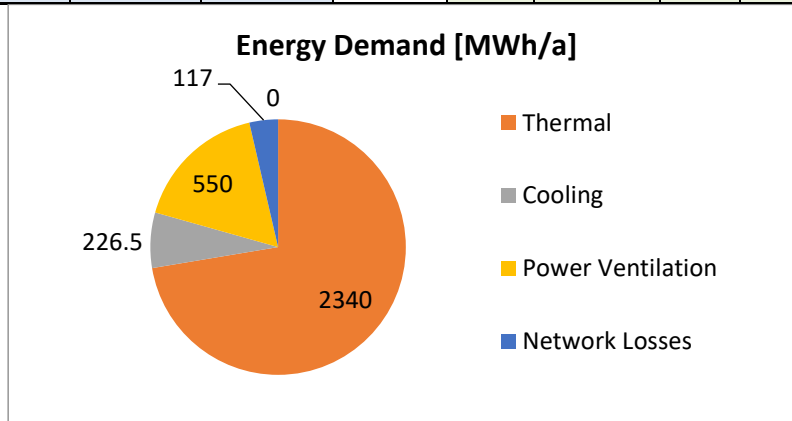
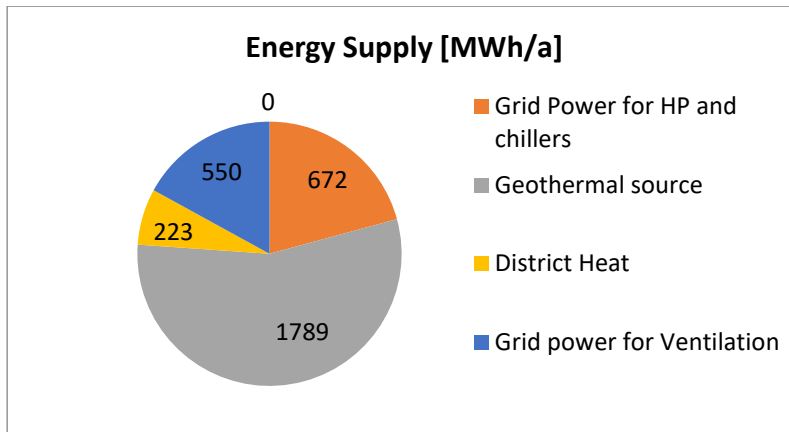

Figure 22. Graphical representation of energy demand.



**Figure 23. Graphical representation of energy supply.**

**Table 16. Additional information on WU Campus Case.**

Building mix in the area*:	Large buildings, used for lecture halls, offices, refectory
Consumer mix in the area**:	Large
Energy plant owner (public or private):	Private for heat, plus public district heat and power supply. Local heat and power distribution after transfer station is private
Thermal energy supply technologies***:	district heat for high temperature heat
ground water and heat recovery from server cooling	for low temperature heat used for radiators and core activation.
Thermal energy production from solar:	None
Geothermal collectors:	Use of ground water sea
Thermal energy storage:	Ground water sea, and an additional 5000L water storage tank
Investment costs****:	~3700 € (All per m <sup>2</sup> of usable area 'm <sub>ua</sub> ')
Cooling energy used:	ground water source, high temperature, heat pumps to cool server rooms and for room heating, cooling demand peaks are covered by an additional decentralized chiller
Available cooling power:	4.5 MW
Voltage level:	10 kV [V] ring starting from public substation
Electric power supply technologies:	Supplied by ring duct, two UPS backup units
Annual electric energy yield:	—
Backup power, critical demand:	Two uninterruptable power supply units (UPS) fed by diesel and kinetic energy of 2500 kVA each to serve 2 server rooms, basic building technology, safety lighting

### 6.4.3 Innovative use of Ground Water

The main technical highlight is the use of ground water for heating and cooling. This was enabled by the construction of a nearby hydroelectric power station, which led to a constant ground water level and ground water flux. The campus building company bought the water rights to be able to use this special situation, which allows heat and cold supply of the whole campus. Only peaks of demand and some high temperature areas are served by district heating. Usually heating is provided by extracting heat from the ground water via plate heat exchanger, and raising the temperature with heat pumps. For space cooling, cool water from the ground is directly used. When necessary, heat pumps are used to further lower the water temperature. Additional cooling by chillers is available for server rooms. To better use the ground water source, the buildings were designed to use a relatively high temperature

source for cooling and a relatively low temperature source for heating. To achieve the goal, the planners opted for highly efficient building envelope and concrete core activation. Figure 24 shows the energy system architecture of WU Vienna.

To summarize, the innovative technical aspects include:

- Use of ground water to produce energy for heating and cooling
- Use of ground water for irrigation and toilets
- Concrete core activation
- Cooling of buildings with high temperatures
- Heating of buildings with low temperatures
- Optimization of instrumentation and control for building services
- Optimization of lighting.

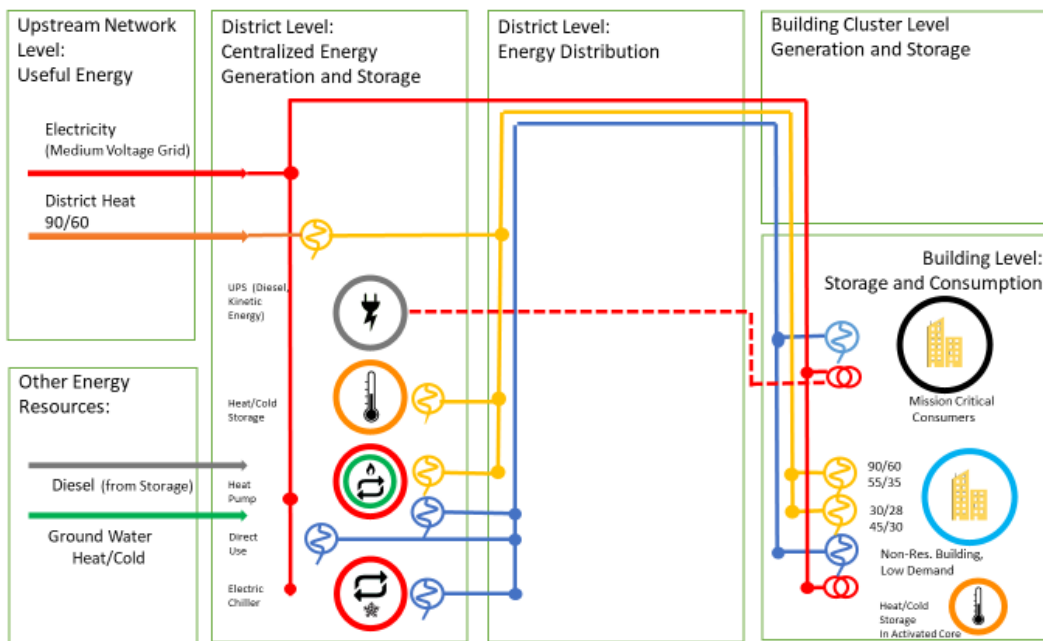

**Figure 24. Energy system architecture of WU Vienna. The Campus is provided with heat and cold from a campus-wide district heating and cooling network. Both heat and cooling are generated from ground source, with a heat pump raising the temperature were necessary (Source: AEE INTEC).**

## 6.4.4 Decision and Design Process

### 6.4.4.1 General/Organizational Issues

Why was this project initiated, to answer which need?

*Need of the WU University for more space, modern infrastructure, centralized structure in nearby buildings. Create new university campus for WU Vienna. Positive effect on the district, improved architectural quality.*

Which stakeholders were involved in the project?

*Future user (WU, ministry responsible for education) and BIG, Vienna town planning, and all interested service institutions (energy, water, nearby power station)*

Which resources were available before the project? What are local energy potentials?

*Available resources were 25 years of university building (BIG) and willingness to rethink the structure of the WU to improve efficiency. Local energy potential is the ground water sea that developed when a hydro power station was built.*

Who (what) were drivers and who (what) were opponents (barriers) – and why?

*Main drivers were BIG for creating a well-functioning and efficient Campus and the user WU, for creating their own campus.*

What have been the main challenges regarding decision finding?

*The main challenges were to find the right organizational method, which turned out to be a company created by BIG and WU (user), and to choose the right location.*

What was finally the crucial parameter for go /no-go decision?

*The alternative to new construction was renovation, this was excluded when in 2006 part of the previous main building was destroyed in a fire. Moreover, it would have been difficult and expensive to bring the former WU buildings to a good status. So the fire in 2006 led the way to the decision to build a new campus and the creation of the new company owned by BIG and WU that would develop, build and maintain the campus.*

#### **6.4.4.2 Financing Issues**

What have been the main challenges/constraints regarding financing?

*There was a fixed limit of 490 Mio agreed upon by the Financing Ministry, which was to be in any case respected. Thus, throughout the project, the costs were observed and calculated by different parties (project leader and building supervision), with their results overlooked by one more party, to be sure not to exceed the planned costs.*

*To reduce risks, works were split in portions that would reduce risks (large enough to allow for standardization and thus efficiency, small enough to allow for competition among applying building companies).*

Which business model applies to the project?

*The project was developed by a company founded on purpose, which belongs to BIG (51%) and WU university (49%). This company organized financing, planning and building. The user (WU university) will pay off investment costs over a fixed period. The local energy supply for heat/cold and power is owned by the company as well.*

#### **6.4.4.3 Technical Issues**

What have been major technical challenges/constraints regarding system design?

*Use of ground water for heating and cooling, since it is not yet state of the art. Another main challenge was to design the quarter in a way that prevents strong winds from developing. Vienna is well-known for being a windy town, and big buildings usually make this matter worse.*

*To handle these problems, simulations of both wind and energy supply (ground water source) were made to handle these risks. Simulations were commissioned to a third-party company.*

What solutions have been considered for generation, storage and load management?

*Generation from ground water, storage in activated concrete construction. Load management is being looked at in the monitoring process.*



#### 6.4.4.4 Design Approach Applied

Which design targets have been set and why?

*Walkable garden with university pavilions, attractive to the public, ground floor areas always publicly accessible. Centralized structure, with flexible and reversible organization, to allow for cost reduction for university administration and later adaptations. (e.g., Offices are standardized, and can be easily converted for changes in staff structure).*

*Certificate ÖGNI. Respect OIB. Building site management according to RUMBA norms of Vienna*

Which decision steps/workflow lead to the retained solution?

- *Decision to create new campus (after fire in 2006)*
- *Foundation of the company (by WU/BIG)*
- *Design concept by WU/BIG, choosing the plot, energy master plan, maximum costs*
- *When the plot was chosen, the decision fell on ground water source*
- *Architecture competition (2 steps).*

Tools:

*Standard: energy simulation (on the outcome the decision fell on use of ground water source), building physics (ventilation, etc.), sun – shadow, CAD Software, Project Platform, different tools for monitoring of costs (project leaders and building supervision both monitored costs, and the results were compared).*

*Two-step architecture competition. Step 1: general planning (sun, shadow) and concept for building ensemble. Step 2: single buildings were designed by winning teams of step 1.*

*Special simulations: ground water use (TU Vienna), wind (weather park)*

What have been the main challenges in the design phase?

*Wind, ground water use*

What have been the most crucial interfaces?

*WU/BIG*

What parameters are controlled via monitoring?

- *Temperatures, energy loads, use of ground water source, use of district heat, data center, building technology*
- *Energy monitoring/energy reports*
- *Periodic Inspections/revisions/controls of the building technology.*

#### 6.4.5 Resilience

Which threats were considered and are to be considered?

*There are action plans for the following threats:*

- *Fire*
- *Power down*
- *Water pipe burst*
- *Sewer burst/flooding*
- *Thunderstorm (e.g., Heavy rain with entering water)*
- *Building collapse/breaking of building parts*
- *Damage to person (incident, elevator damage)*

- *Threat by third party (break in, theft, robbery, vandalism, bomb threat, violent demonstration, amok, hostage-taking)*
- *Scenario World Health Organization (WHO) Step 6 (plans for pandemic).*

Are there redundancies in the energy supply system?

*There are redundancies in all energy systems, i.e., heat, cold, power and data.*

*For heat, there are three sources, namely public district heat, heat recovered from server rooms and heat from the ground water source.*

*For cold, there are three sources, namely ground water and heat pumps and chillers, both depend on power*

*Both heat and cold supply is secured by onsite storage in activated concrete cores and a buffer storage.*

*For power, an internal ring duct has been created, and the WU campus is served by two different connections from the public grid. Moreover, there are two UPS systems installed, both of which with short term kinetic supply and diesel generators.*

*For information (internet), two different supply chains for information (internet) are fed by two different backup power supplies (fly wheels)*

Which processes that require heat, cooling or power are there? Which ones are critical? (Order by priority). What is the possible timeout without imposing damage?

- *Data center (power, cooling)*
- *Safety illumination (power)*
- *Basic Thermogravimetric Analysis (TGA) (power), e.g., for ventilation.*

Are there backup systems? On which time-scale can they be accessed?

*For power backup, two dynamic UPS systems with both 2500 kVA have been installed. These serve the data centers and safety illuminations, and also the uninterruptible power supply for building technology, in case of a power breakdown.*

## **6.4.6 Lessons Learned**

### **6.4.6.1 Major Success Factors**

One important point was to find the right lot, which could also be used for local energy generation and even more importantly guaranteed a high accessibility by public transport.

Another important factor was to find the right organizational structure to allow WU and BIG to develop this project together, and to define common targets and fulfill all requirements.

### **6.4.6.2 Major Bottlenecks**

Now that all things have been worked out, there seem to be no bottlenecks. One bottleneck must have been to check energy system is feasible, the other to keep costs below threshold.



### 6.4.6.3 Major Lessons Learned

Ground water can be a powerful source of energy. In such a big project, it is very important to use different methods to check costs and to split work in feasible, competitive, yet still economical pieces.

What should be transferred from this project:

*For this project, the lot and its surroundings were essential and strongly determined the outcome.*

## 6.5 Air Base Skrydstrup in Denmark

Case No.	Country	Location	Specific Type	Photo	Special points of attention
5	Denmark	Skrydstrup	Military air base		 <p>biogas CHP, district heat, thermal storage</p>
<b>Country:</b> <b>Title of case study:</b> <b>Location of case:</b> <b>Author name(s):</b> <b>Author email(s):</b> <b>Author name(s):</b> <b>Author email(s):</b>				Denmark Resilient and renewable energy system for air base 55°14' North 9°15' East Anders N. Andersen ana@emd.dk Jens Peter Sandemand FES-BES25@mil.dk	

### 6.5.1 Background and Framework

Fighter Wing Skrydstrup (FWSKP) is located at Air Base Skrydstrup in Denmark, and comprises Squadron 727 and Squadron 730, today having in total 44 F-16 Fighting Falcons. Current plans are to add another 22 F-35s after 2023. A total of 850 persons are working at the air base.

Today the electricity and heating demand at the camp are met by natural gas CHP and imported electricity.

#### 6.5.1.1 Climate conditions at Skrydstrup

In an average year, the ambient temperature in Skrydstrup is 8.1 °C, with a maximum daily average temperature of 22 °C and a minimum daily average temperature of -9 °C, as shown in **Error! Reference source not found.**

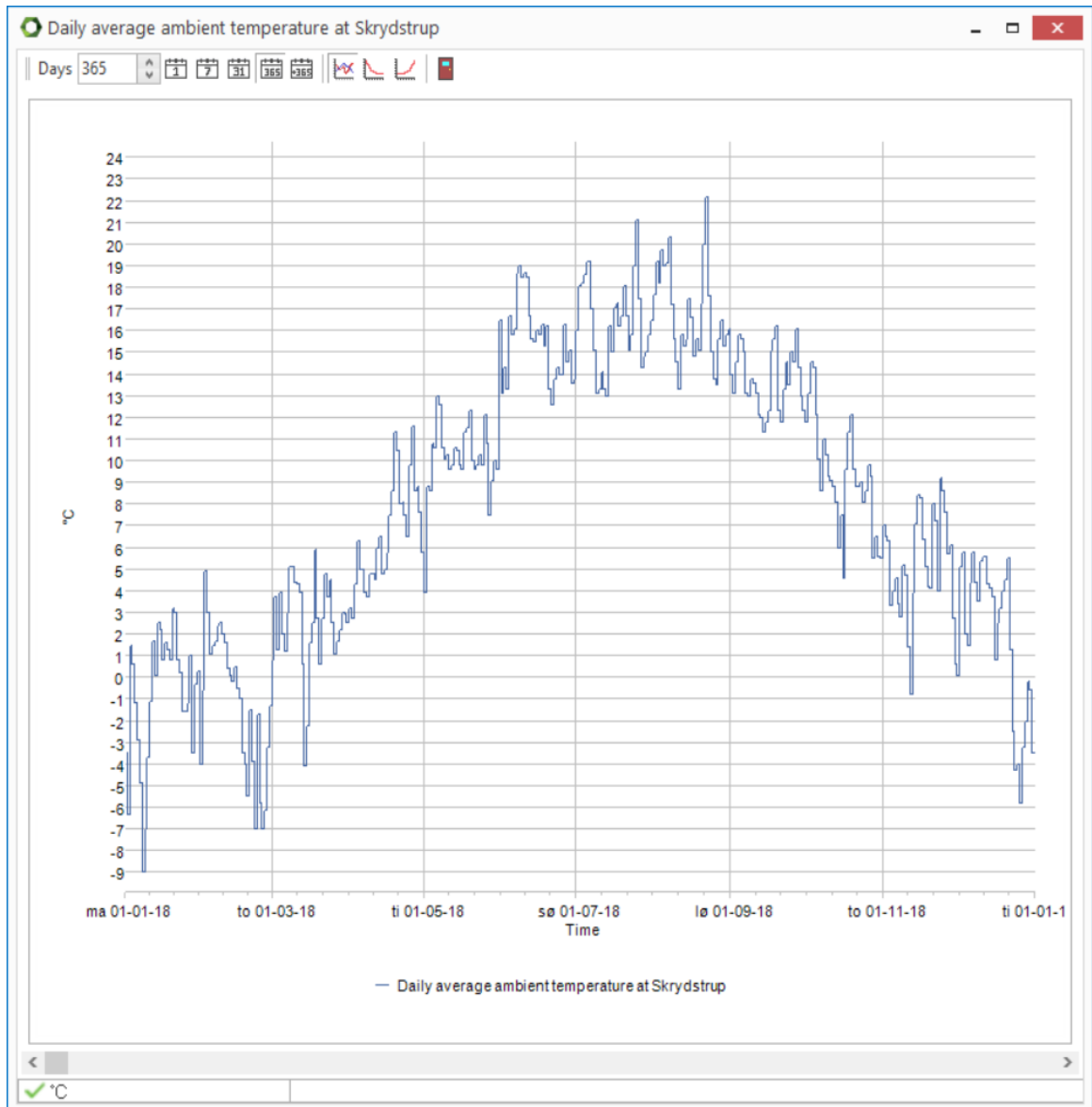

**Figure 25. Daily average ambient temperature at Skrydstrup. Created with Energy system analysis [energyPRO](#).**

In an average year, the global radiation at Skrydstrup amounts to 1000 kWh/m<sup>2</sup>. The hourly global radiation in an average year shown in **Error! Reference source not found.**

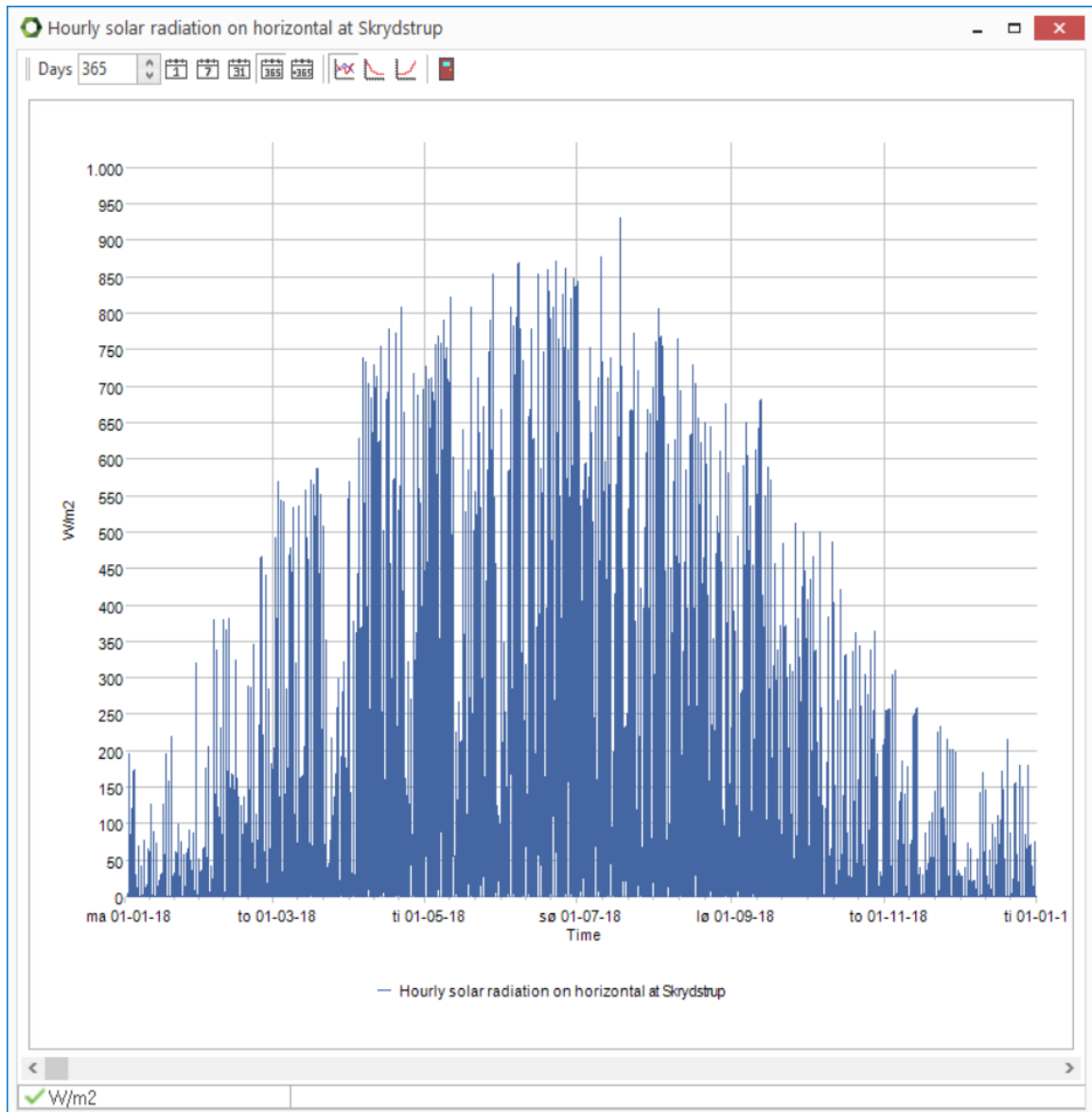

Figure 26. Global radiation at Skrydstруп in an average year. Created with Energy system analysis [energyPRO](#).

### 6.5.1.2 Heating and Electricity Demand at Skrydstруп Air Base

After 2023, when the base will have acquired an additional 22 F-35s, the yearly heating demand will amount to 11,300 MWh-heat, with a daily average maximum heat demand of around 3.2 MW-heat. The variation of the heat demand inside a day is averaged by an existing thermal storage. **Error! Reference source not found.** shows the duration curve for the heat demand. The yearly electricity demand will amount to 10,000 MWh-el, with a maximum electricity demand of around 2.7 MW-el (**Error! Reference source not found.**).

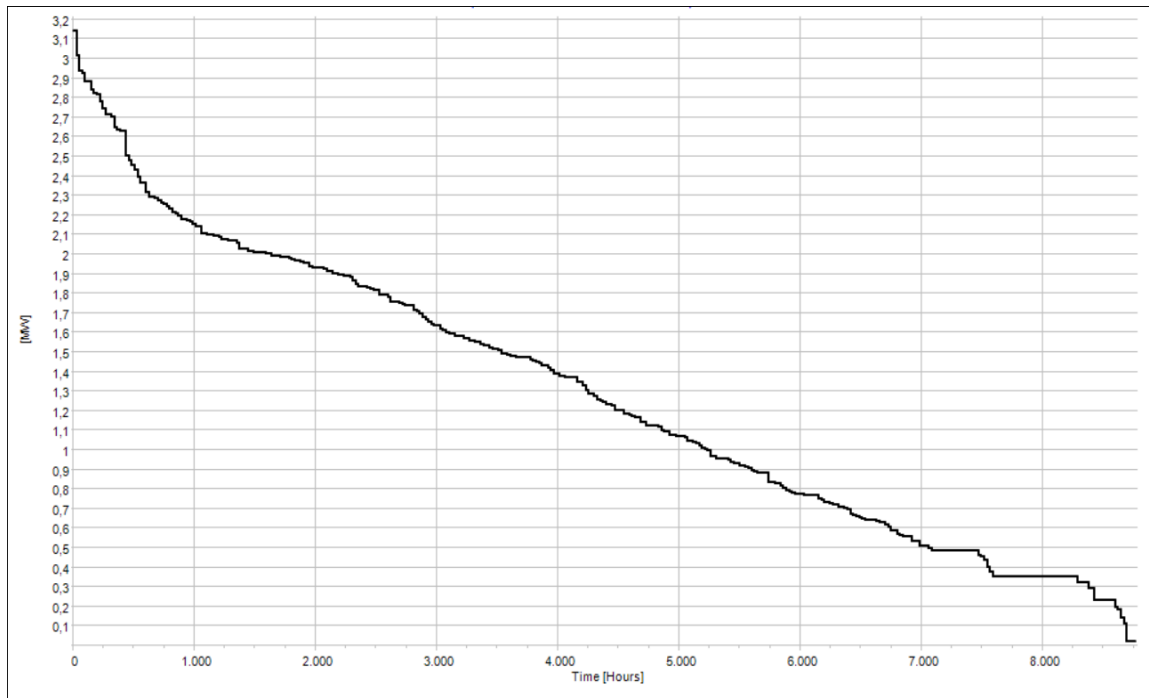

Figure 27. Duration curve for heat demand at Skrydstrup Air Base. Created with Energy system analysis [energyPRO](#).

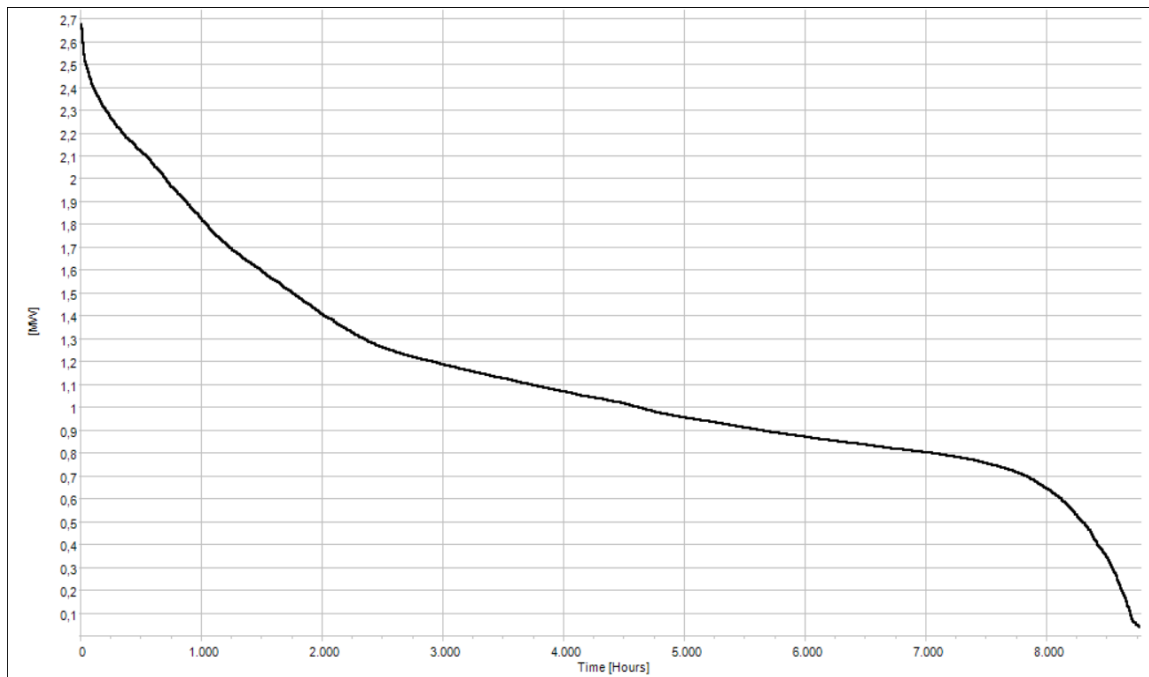

Figure 28. Duration curve for electricity demand at Skrydstrup Air Base. Created with Energy system analysis [energyPRO](#).

### 6.5.2 Innovation: CHP using Local Biogas

A nearby biogas plant is being built, which will make it possible to configure a resilient and renewable energy system of Air Base Skrydstrup, where the electricity and heating demands of the future are based entirely on a biogas CHP, assisted by an electrical battery.

### 6.5.3 Resilience in the Future Energy System at Skrydstrup Air Base

This section analyses the resilience in the future energy system at Skrydstrup Air Base, after connecting the base to the nearby biogas plant. The present four CHP's will be adapted to being able quickly to shift from being natural gas fired, to being biogas fired. Each of these CHPs has an electrical capacity of 1 MW-el and 1.2 MW-heat, giving a total of 4 MW-el and 4.8 MW-heat. As shown in Figures **Error! Reference source not found.** and **Error! Reference source not found.**, this change will allow all hours of the year both the heat demand and the electricity demand to be covered.

The existing thermals storage of 250 m<sup>3</sup> (12 MWh-heat) will still be available in 2023; in addition, a cooling tower and a 12 MWh electrical battery will be installed.

The resilience of Skrydstrup Air Base was modeled in the energy system analysis tool energyPRO. Figure 29 shows simulation results for a winter week, when Skrydstrup Air Base is electrically operated in island mode, with no access to the public electrical grid. It is assumed that only two out of the four CHP's are available in this week, due to maintenance of the two others. Monday 2<sup>nd</sup> of January 2023 these two are not able to cover the electricity demand in 3 hours. The remaining demand for electricity in these 3 hours is delivered from the battery (as seen in the lower graph). Friday 6<sup>th</sup> of January the thermal storage is emptied in the middle of the day because the electricity demand is low, restricting the CHP-production. Here it is chosen to cover the rest of the heat demand by natural gas fired boiler production. To enlarge the resilience, the natural gas fired boiler could have been adapted to also being operated on biogas.

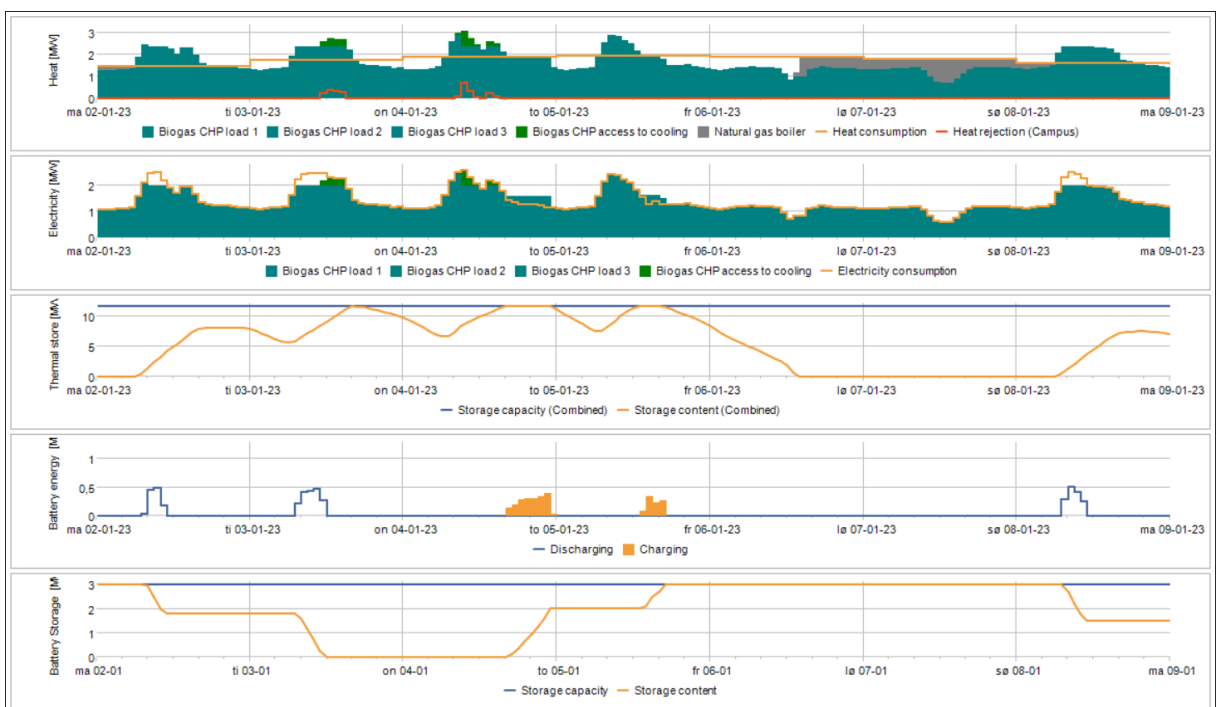

**Figure 29. Resilience in a winter situation at Skrydstrup Air Base operated electrically in island mode. Created with Energy system analysis [energyPRO](#).**

Figure 30 shows simulation results for a summer week in 2023, where Skrydstrup Air Base is electrically operated in island mode, with no access to the public electrical grid. In this situation, the CHP's get access to the cooling tower because the heat demand is low. The heat dumped in the cooling tower is shown in the upper graph with a red line.

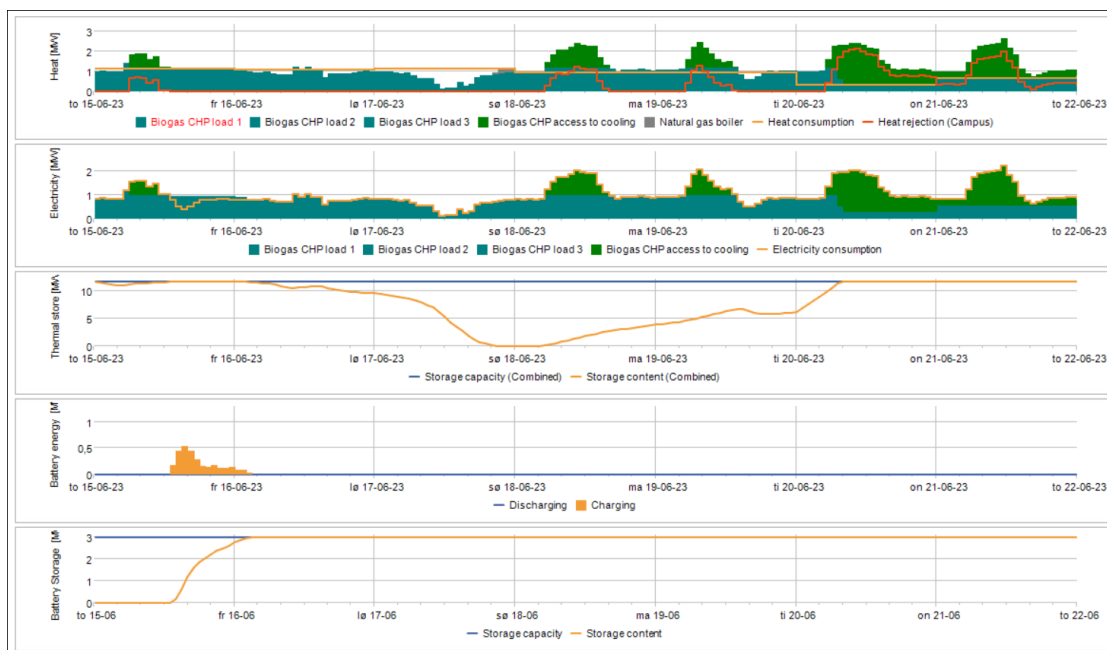

**Figure 30. Resilience in a summer situation at Skrydstrup Air Base operated electrically in island mode. Created with Energy system analysis [energyPRO](#).**

The yearly amount of biogas used will amount to 4.2 million Nm<sup>3</sup> (1 Nm<sup>3</sup> biogas = 6.2 kWh).

## 6.6 District Heating Based on CHP and Waste Heat in Taarnby, Denmark

Case No.	Country	Location	Specific Type	Photo	Special points of attention
6	Denmark	Taarnby	Energy Supply System District heating in a town including a large airport campus		 low carbon heat e.g. wasted-fueled CHP, district heating
<b>Country:</b>		Denmark			
<b>Name of city/municipality/public community:</b>		Taarnby Municipality, Greater Copenhagen			
<b>Title of case study:</b>		District heating based on CHP and waste heat			
<b>Author name(s):</b>		Anders Dyrelund			
<b>Author email(s):</b>		ad@ramboll.com			
<b>Link(s) to further project related information/publications, etc.:</b>		<a href="https://ec.europa.eu/irc/en/publication/efficient-district-heating-and-cooling-markets-eu-case-studies-analysis-replicable-key-success">https://ec.europa.eu/irc/en/publication/efficient-district-heating-and-cooling-markets-eu-case-studies-analysis-replicable-key-success</a>			

### 6.6.1 Background and Framework

Taarnby Municipality is the owner of Taarnby Forsyning public, which owns and operates services for wastewater and water in the municipality and district heating to most buildings larger than 500 m<sup>2</sup>, including Copenhagen Airport. Taarnby is part of the integrated district



heating system in Greater Copenhagen (see case 1 in the link above) and the municipality is co-owner of the heat transmission company CTR (see Figure 31).

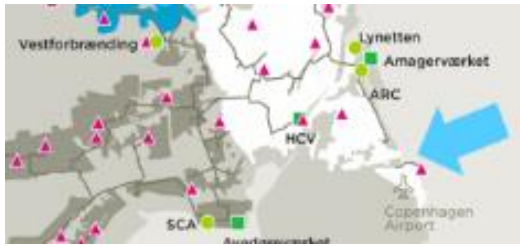

**Figure 31. Map of Greater Copenhagen District heating and Taarnby (Source: Taarnby Forsyning and Ramboll).**

Taarnby Public Utility formed in 1982 a new business unit for district heating system, which has been further developed and integrated with the Copenhagen Airport campus.

### **6.6.1.1 District Heating (DH) Project**

Taarnby Municipality (Figure 32) was one of 20 local authorities, which in 1981 were invited by the Minister of Energy to take part in the formation of the integrated district heating system in Greater Copenhagen. The goal was to replace oil with heat from existing and new large, CHP plants, as well as heat from waste incinerators combined with a new gas infrastructure. Taarnby Public Utility was already a supplier of water and wastewater, and the utility formed a new small business unit with the aim of planning and implementing district heating.

Taarnby Municipality joined the municipal partnership heat transmission company CTR, who got the obligation to establish a heat transmission system in the five central municipalities in Greater Copenhagen, to interconnect with the other two metropolitan transmission companies VEKS and Vestforbrænding, as well as all heat producers in the area to operate the system in an optimal way and to transmit the cheap low carbon heat to all five owner municipalities including Taarnby.

Taarnby Municipality joined the new gas distribution company HNG, which had to develop a gas infrastructure in owner municipalities and supply gas for heating in gas zones.

Taarnby Municipality took part in the regional energy planning in cooperation with the Ministry, other municipalities and all local stakeholders.

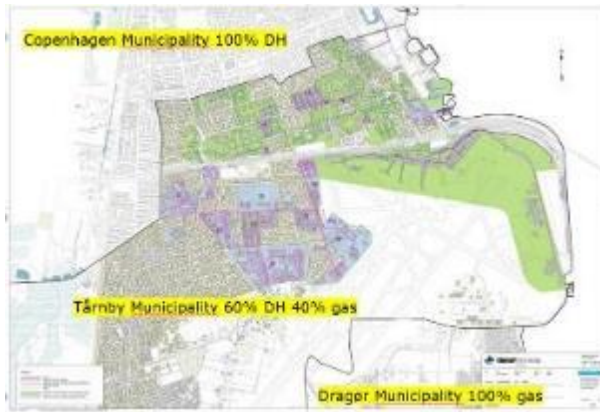

**Figure 32. Map Taarnby Municipality including zones of District heating and pipes. Green districts. DH system established in 1985. Blue districts. Planning to shift from gas to DH in 2020-2030. District without color. One-family houses. An option to shift from gas boilers to DH or to heat pumps in 2030-2050. (Source: Taarnby Forsyning and Ramboll.)**

## 6.6.2 Energy Objectives

The objectives of the energy planning and project implementation were to:

- Replace the dependency of oil with district heating and gas
- Save energy
- Develop the most cost-effective zoning of district heating and gas for the society
- Supply consumers with cheaper heat from district heating.

The outcome of the municipal heat supply planning and the business planning of the utility around 1982 was the development of the most cost-effective district heating system to all buildings larger than ~500 m<sup>2</sup>, located north of the airport including the airport campus, which had its own district heating (or campus heating) system. Accordingly, districts with smaller buildings plus the district south of the high way were supplied with individual gas boilers.

The district heating system is supplied by a 60 MW heat exchanger station from CTR in the northern part and a backup oil-fired boiler plant at the airport in the southern part.

In the first stage, the airport campus network was separated from the district heating system of Taarnby with a heat exchanger at the old boiler plant of the airport.

At a later stage, the boiler plant was closed as the space was vital for parking, and a new plant was established at a more convenient location south-east of the airport area. Later, the heat exchanger between the two networks was removed, thereby integrating the city network with the campus network to improve the efficiency of the operation and avoid temperature drop.

The map in Figure 32 shows the existing green district heating zones and the existing green district heating pipe network of Taarnby District Heating. The green district heating areas south of the east-west going high way and train to Sweden is Copenhagen airport with its own distribution network. The blue districts are included in a business plan for the extension of the district heating to large buildings and terrasse houses. The districts in Taarnby with no color are supplied with gas.

The map also shows parts of the two neighboring municipalities: Copenhagen with 100% DH supply and 99% connection, and Dragør with 100% gas supply.

In the zoning of the district heating, it is important only to develop the network in case it is cost effective. The key parameter is the necessary investment cost in DKK per heat sale in MWh. The data listed in Table 17 illustrate this key figure.

**Table 17. Quantitative Information on Taarnby District Heating; Investment key figures and heat losses calculated.**

Development of Tårnby DH	Demand	Network invest.	Key figure	Heat loss	Alternative
Districts	MWh	1000 DKK	1000DKK/MWh	%	individual
First network in 1985	115.909	253.079	2,2	6,8%	gas boiler
Campus in long-term development	54.953	74.175	1,3	5,6%	oil boiler
<b>Total incl. Campus</b>	<b>170.862</b>	<b>327.254</b>	<b>1,9</b>	<b>6,3%</b>	
First extension 2020	30.838	42.594	1,4	5,0%	gas boiler
New urban development	5.635	17.826	3,2	10,4%	heat pump
Second extension 2025?	11.201	41.147	3,7	11,0%	gas boiler
<b>Total without small houses</b>	<b>218.535</b>	<b>428.821</b>	<b>2,0</b>	<b>6,6%</b>	

Table 17 lists the heat sale to consumer and the investments in the existing networks both with and without the airport network.

In case all the networks in the green district heating zones (Figure 32) supplying 171 GWh should be replaced, including the airport network, it would cost 327 million DKK and the heat loss would be 6.3%.

As all heat production and all heat consumption have been measured, it has been possible to monitor the heat loss of the 35-year-old network, and it has been confirmed that it is 7%.

The blue zones, which most likely should be supplied within the next 10 years, are shown above and have been split into three zones. The most profitable extension of 31 GWh to replace gas boilers, and the new urban development in which gas boilers are not an option and district heating, is significantly more cost effective than individual heat pumps, in spite of a heat loss of 10%. The 11 GWh least profitable part of the blue zones is twice as expensive as the most profitable one per heat sale, and the heat loss is also twice as large.

Figure 33 shows the accumulated demand for the 132 connected heat consumers, including the airport. Table 18 lists additional Information on Taarnby District Heating.

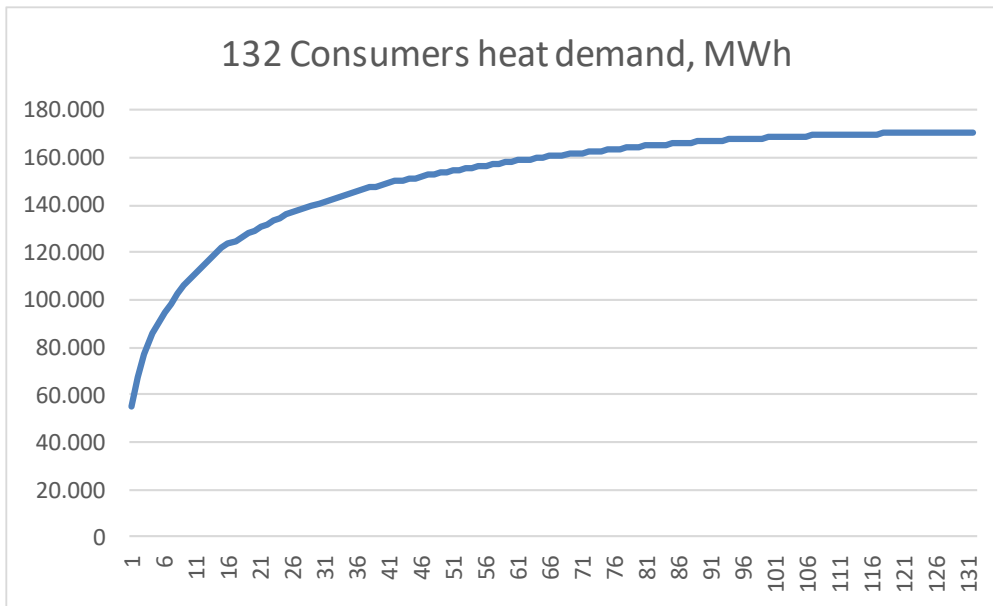

**Figure 33. Accumulated demand for all 132 heat consumers.**

**Table 18. Additional Information on Taarnby District Heating.**

<b>Building mix in the area:</b>	Office buildings and apartment buildings
<b>Consumer mix in the area:</b>	Large consumers
<b>Energy plant owner:</b>	Public
<ul style="list-style-type: none"> <li>• 180 GWh Maximal design heat load in a normal year</li> <li>• 3.000 max load hours measured and estimated based on actual consumption and weather data</li> <li>• 60 MW maximal design capacity to the network</li> <li>• 60 MW capacity of heat exchanger from CTR</li> <li>• 60 MW capacity of oil-fired backup boiler at the air port</li> <li>• 6.5 MW planned heat capacity from new heat pump for combined heating and cooling</li> <li>• 132 consumers, incl. Copenhagen Airport campus</li> <li>• 178 GWh annual heat production</li> <li>• 170 GWh annual heat sale, of which 55 GWh are to the airport</li> <li>• 9.5 GWh annual heat loss in the city network (excluding the campus), equal to 5.3%</li> <li>• 12.7 GWh losses incl. airport network measured, equal to 7%</li> <li>• 8.5 GWh annual heat loss for new pipes, calculated</li> <li>• 11.7 GWh annual heat loss incl. the network of the airport for new pipes, calculated</li> <li>• 28 km DH network, DN20-DN500 + 10 km airport</li> <li>• Normal supply temperature 75-95 °C</li> <li>• Normal return temperature 50 °C</li> <li>• Preinsulated pipes from 1985 with surveillance system</li> <li>• Remaining lifetime of the network? <b>50 years more?</b></li> <li>• Heat exchanger between DH and campus is removed</li> <li>• Heat exchangers between the integrated network and all radiator systems in buildings</li> </ul>	

### 6.6.3 Technical Highlight

Figure 34 shows the construction of district heating and cooling to a large office building.

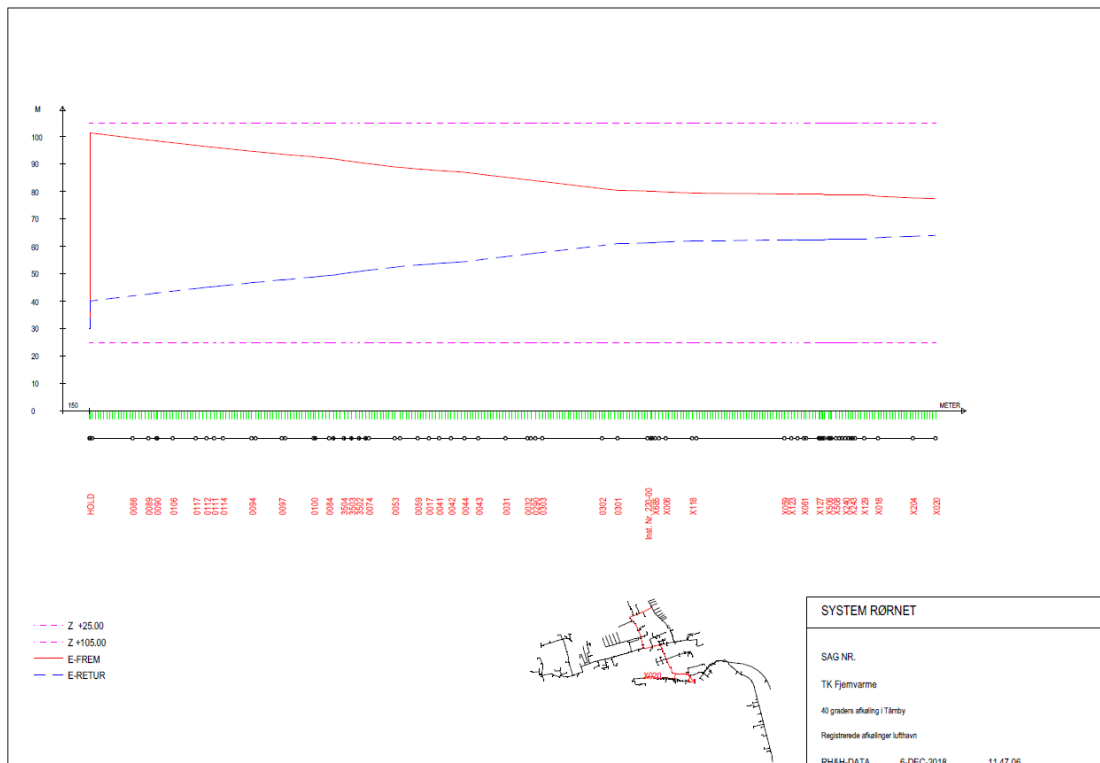

**Figure 34. District heating pipes to a large customer (Source: Taarnby Forsyning and Ramboll).**

Figures 35 and 36 are derived from the hydraulic model SystemRornet, which has been used to analyze the design of the district heating system of Taarnby and the operation of the interconnected network. The GIS data from the model is mixed with a photo of the area, and the location of the production plants, including the coming heat pump, is indicated.



**Figure 35. Trench of the network from the hydraulic model. Source: Taarnby Forsyning and Ramboll.**



**Figure 36. Pressure diagram for supply of maximal heat from the heat transmission system via the heat exchanger (Source: Taarnby Forsyning and Ramboll, created with System Rornet).**

## 6.6.4 Decision and Design Process

### 6.6.4.1 General/Organizational Issues

The project was initiated for several reasons:

- To implement the national energy policy with the aim of reducing the dependency of oil in a cost-effective way by using heat from waste and CHP and in combination with natural gas
- To take part in the establishment of an integrated district heating system in Greater Copenhagen that supplies heat from existing and new CHP capacity and waste incinerators to local district heating systems
- To identify the optimal zoning between district heating and gas networks in the Municipality of Taarnby and establish the system
- To deliver reliable and competitive heat to all buildings in the district heating zones.

The major stakeholders were:

- The Ministry of Energy
- The Municipality of Taarnby
- The public utility of Taarnby
- The heat transmission company CTR
- The airport as consumer and owner of a large boiler plant
- The gas company.

Stakeholders involved in the project were:

- The public utility of Taarnby was responsible for the business plan and the implementation
- The municipality of Taarnby was authority responsible for preparing the heat plan and submitting it to the Ministry
- The municipality was on behalf of the heat consumers and citizen one of the founders of CTR
- The Ministry approved the heat plan.

Resources available before the project and local energy potentials were:

- There were a large surplus heat capacity from waste incinerator and CHP plant not far from Taarnby, which could be transmitted to Taarnby by CTR.
- There was no local heat potential in the municipality, except that the heat-only boiler of the airport could serve as peak capacity and at the same time continue to be backup for the airport for resilience.

Drivers (who, what) and opponents/barriers(who, what) – and underlying reasons were:

- The main driver was that the government wanted to reduce the dependency on oil.
- The gas company would prefer to supply all the large consumers, but this was prevented by the heat planning, as the company was not allowed to establish pipes and supply consumers in the district heating zones. Likewise, the district heating company were only allowed to supply heat to the zones that had been approved for district heating.

The main challenges regarding decision finding were:

- The main challenge was to agree where to establish the next new CHP plant.

The crucial parameter for go /no-go decision was:

- The crucial parameter was an agreement on where to establish the CHP plant (two new instead of one large), which paved the way for agreement on the heat transmission and thereby the obligation for Taarnby to establish the district heating network.

#### **6.6.4.2 Financing Issues**

The financing was not a problem, as the project was profitable compared to the base line and that it therefore was possible to set-up a business plan for payback of the investment. Finally, the municipality could guarantee for the loans and obtain very competitive credits to finance 100% of all investments plus deficit.

Which business model applies to the project?

- *The company CTR takes care of all heat production including heat capacity to the distribution grid, which for Taarnby includes transmission of heat to the distribution network, including the primary side of the heat exchanger and peak capacity from the boiler plant of the airport.*
- *The company CTR rents the existing large boiler plant of the airport and later, as it had to be removed, CTR establishes and owns the new peak load boiler plant.*
- *Taarnby District Heating Company establishes the network and supply heat to all buildings, and operates the secondary side of the heat exchanger station and the boiler plant.*
- *The consumers establish and operate their own district heating substation, which replaces the existing oil-boiler installation.*

- *The Heat Supply Act specifies that the heat price can only include the necessary costs and not dividend to owners. Accordingly, the consumers pay the actual costs of heat and they therefore benefit from the long-term profitability of the project.*

### **6.6.4.3 Technical Issues**

What were the major technical challenges/constraints regarding system design?

*There has been no major challenges, maybe except that the return temperature from the airport and some consumers turned out to be too large. Therefore, the company has undertaken several initiatives to help the consumers reduce the return temperature and has also introduced a tariff incentive for lower return temperature.*

What solutions have been considered for generation, storage, and load management?

*The transmission system has from the first day of operation been managed in the most optimal way, from the control centers via a Supervisory Control And Data Acquisition (SCADA) system with optic fiber cable connection to all substations and plants as well as remote-controlled stop valves and pumps.*

*In the operation of the distribution system, variable-speed-drive pumps have ensured optimal operation.*

### **6.6.4.4 Design Approach Applied**

Which design targets have been set and why?

*The targets were to establish a system in accordance with the standard for district heating pipe networks to ensure long lifetime of the system.*

*Network dimensions were optimized with respect to the life cycle costs, including avoided costs of booster pumps by using the maximal possible pump heat at peak load.*

*The heat exchanger substation was designed to meet the long-term expected baseload capacity demand, which corresponds to around 100% of the total demand the first years.*

Which tools have been used during the design phase? Include name, originate (plus web link), purpose of the tool, specific use of the tool within the case study, practical experiences during application, cost/price (if commercial tool)

*The hydraulic analysis of the district heating system has been executed by the hydraulic system SYSTEMRORNET and the existing model for simulating the district heating system for maximal base load and peak load.*

*ArcGIS has been used to extend the existing GIS model with information of the district heating to plan the route and connections to buildings.*

*The business plan has been prepared by Ramboll's business plan model for district heating and long-term budget.*

What have been the main challenges in the design phase?

*No particular challenge, except the integration of the city network and the network of the airport, as it has to be decided to what extend the substations and pipes of the internal airport network could meet the standard.*

What have been the most crucial interfaces?

*The integration of the city network and the network of the airport.*



### What parameters are controlled via monitoring?

*The heat exchanger station and the peak boiler are monitored and controlled by CTR.*

*The pressure difference in the network is monitored and used to regulate the variable-speed-drive pumps.*

*The heat meters are monitored for billing by the district heating company.*

### **6.6.5 Resilience**

The heat supply from the 60 MW heat exchanger and the 60 MW boiler plant is optimized, regulated, controlled, and monitored by the control center of the transmission company CTR with the help of a SCADA system. This system has in principle been in operation since it was constructed in 1985 with optic cables for data transfer and local as well central computers, and upgraded for adopting new computer technology. Taarnby District Heating Company is responsible for the operation of the secondary part of the substation with regard to optimization of supply temperature and control of the pressure at strategic ends of the network.

The total district heating system is very reliable, and the total capacity is designed to meet the demand while the largest unit is out of operation. As oil boilers have lowest priority, the oil-fired boiler plant will only be in operation for peak load on the very coldest days in case other production plants fail.

The backup boiler can offer maximal backup capacity in case the heat transmission system breaks down, and in particular it can offer backup to the airport and other buildings south of the crossing of the railroad and highway.

The pipe network is monitored by a standard surveillance system, with two wires, which are installed in the pipes. Thereby it is possible to detect a fault or a leak and prevent outside corrosion.

The pressure maintenance system can add water in case the temperature is reduced and eject water in case the temperature is increased and the water volume expands. The net water loss, which is close to zero, is monitored to detect any leak in pipes or in hot water heat exchangers.



With regard to the branches of the network, all pipes except for the critical crossing can be repaired within 24-hours and thus offer sufficient resilience for ordinary comfort heating.

### **6.6.6 Lessons Learned**

The project is a good model for modern district heating and it has been in successful and efficient operation for more than 30 years.

It has also proven that it is a good idea for city district heating companies and campus owners to cooperate to find the best common solutions. The project has demonstrated that municipal-owned utilities operating vital infrastructure in their cities are able to identify the cost-effective energy solutions and implement them to the benefit of consumers, in fact acting like the whole municipality was one campus. Therefore, the case is a good story for campus owners.

## 6.7 District Cooling in Symbiosis with District Heating and Wastewater in Taarnby, Denmark

Case No.	Country	Location	Specific Type	Photo	Special points of attention
7	Denmark	Taarnby	Energy Supply System District cooling in an urban development area		 district cooling
<b>Country:</b>		Denmark			
<b>Name of city/municipality/public community:</b>		Taarnby Municipality, Greater Copenhagen			
<b>Title of case study:</b>		District cooling in symbiosis with District heating and wastewater			
<b>Author name(s):</b>		Anders Dyrelund			
<b>Author email(s):</b>		ad@ramboll.com			
<b>Link(s) to further project related information/publications, etc.:</b>		<a href="https://ec.europa.eu/jrc/en/publication/efficient-district-heating-and-cooling-markets-eu-case-studies-analysis-replicable-key-success">https://ec.europa.eu/jrc/en/publication/efficient-district-heating-and-cooling-markets-eu-case-studies-analysis-replicable-key-success</a>			

### 6.7.1 Background and Framework

Taarnby Municipality is the owner of Taarnby Forsyning public, which owns and operates services for wastewater and water in the municipality and district heating to most buildings larger than 500 m<sup>2</sup>, including Copenhagen Airport (Figure 37). Taarnby is part of the integrated district heating system in Greater Copenhagen (see case in link above) and co-owner of the heat transmission company CTR.



**Figure 37. Map of Greater Copenhagen District heating and Taarnby (Source: Ramboll).**

Taarnby Public Utility has in 2018 established a new business unit for district cooling and is in 2019 establishing district cooling to a new urban development area, Scanport (Figure 38).



**Figure 38. Artist's rendering of the District cooling (Source: Taarnby Forsyning and Skanska).**

Taarnby Public Utility has, in the role of supplier of water, wastewater, and district heating, been in close contact with the urban development department and been able to screen the potential for district cooling, and prepared a feasibility study for using the synergies within the utility.

The study showed that it was profitable in the long-term establishing traditional district cooling based on the same technology that would otherwise be used in the individual buildings, and that the profitability would be even better in case of installing a heat pump and a chilled-water storage to use the symbiosis between heating and cooling. Moreover, it turned out to be very profitable to use surplus capacity of the heat pump to increase the heat production based on ambient heat in the treated wastewater, located just north of the new urban development area, thus including wastewater in the symbiosis. Potential ground source cooling might even improve the system.

The heat pump will be connected to the treated wastewater to use available capacity to generate heat only to the district heating network in an optimal way considering electricity prices and heat production prices in the Greater Copenhagen District heating system.

Figure 38 shows a rendering of the first stage of the new urban development area to be supplied with district cooling. In the upper left corner, we see the wastewater treatment plant and the planned district cooling plant with chilled-water storage (green roof). The existing buildings, the aquarium "The Blue Planet," had already installed a chiller with connection to sea water, but it is expected that it will be included in the project soon due to difficulties with the sea water in-take. The open area left of the new buildings is reserved for the second stage of the urban development. The third stage is further to the west.

The district cooling plant for combined heating and cooling will, as shown at the picture above, be situated at the wastewater treatment plant, at which there is just enough available space. As the picture shows, a roof covering the water basin has been installed to prevent poor environmental impact of offensive odors from the untreated wastewater in the neighborhood.

## 6.7.2 Energy Objectives

The objectives were in the first stage to explore the symbiosis between heating and cooling and in the final stage also wastewater. That will provide the building owners in the district with competitive and environmentally friendly cooling and at the same time to generate more cost-effective heat to the district heating business unit to the benefit of all the heat consumers.

The economic analysis showed that:

- There is a significant economy of scale factor by establishing district cooling in the densely fully developed urban development area.
- It is cost effective to generate combined heating and cooling compared to cooling only, even though the alternative production cost at CHP plants is low, and that it is cost effective to generate additional heat by cooling the treated wastewater.

As the heat pumps are connected to both a chilled-water tank, ground source cooling, and the district heating system, it is possible to optimize the production with respect to both electricity prices and the alternative heat production cost. Figures 39 and 40 show the production of heat and cold from the plant.

Figure 39 illustrates the efficient generation of cooling to the district cooling grid divided on cooling in combined production with heat and the cooling, which is generated based on chillers or wastewater in case of very low heat prices. Figure 40 illustrates the total heat generation to the district heating system from the combined production of heat and cold and from using the heat in the wastewater. Table 19 lists additional information on Taarnby district cooling.

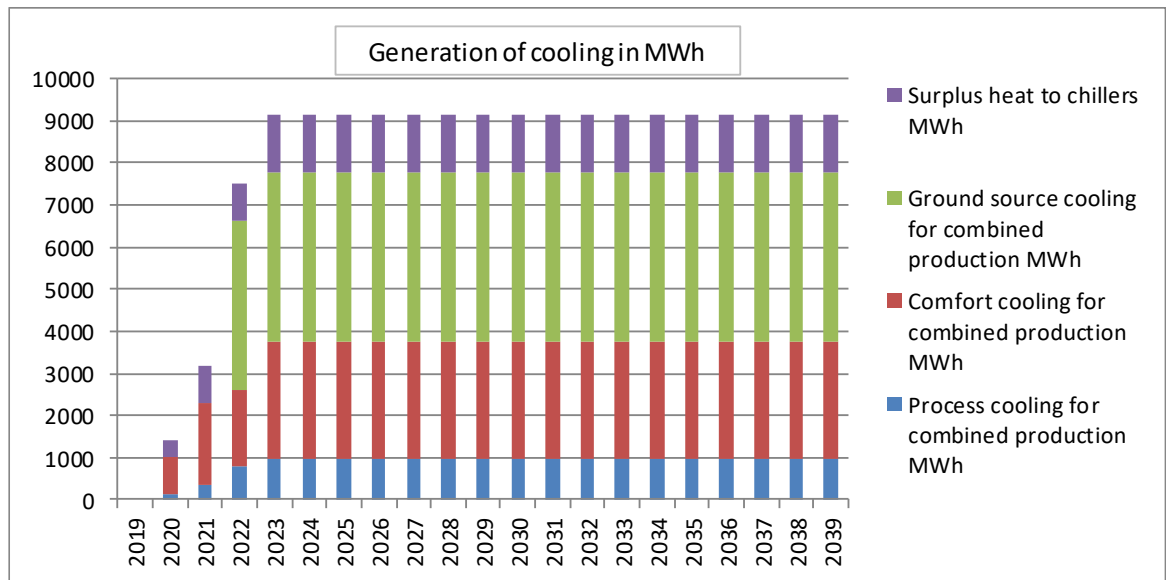

Figure 39. Production of cooling.

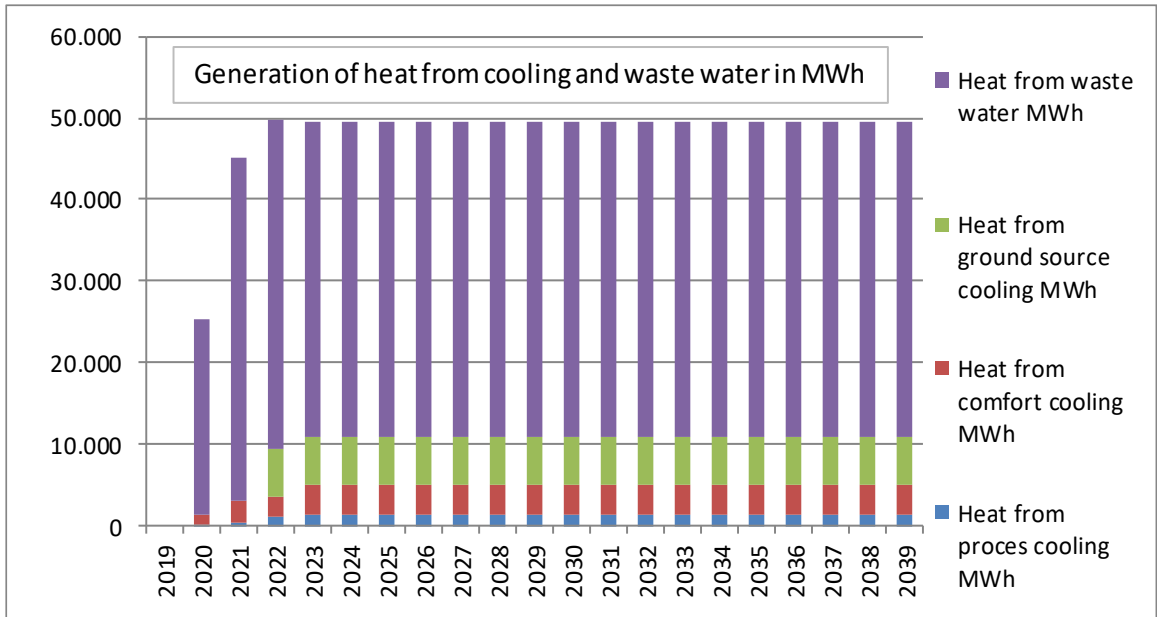

Figure 40. Production of heat.

**Table 19. Additional Information on Taarnby district cooling.**

<b>Additional information</b>		<b>Stage 1</b>	<b>Stage 2</b>
No of buildings	no	3	11
Floor area in total	m2	55.000	170.000
<b>Energy</b>			
Cooling demand	MWh	3.534	9.094
Cooling capacity demand	MW	4,3	10,2
Expected capacity to network	MW	4,3	9,2
Heat pumps cold	MW	4,3	4,6
Stoage tank capacity	MW	1,2	2,5
Ground source cooling	MW	0	2,0
Total installed cooling	MW	5,5	9,2
Heat pumps heat	MW	6,7	6,7
Heat from combined H&C	MWh	4	11
Heat from waste water	MWh	41	39
Total heat generation	MWh	45	50
<b>Investments</b>			
Building	Mill.DKK	4	4
Ground source cooling	Mill.DKK	0	9
Heat pump	Mill.DKK	38	41
Waste water heat exch.	Mill.DKK	2	2
Chilled water tank	Mill.DKK	4	4
District cooling grid	Mill.DKK	10	14
Consumer connections	Mill.DKK	2	5
Connection to DH network	Mill.DKK	3	3
<b>Total investmetns</b>	Mill.DKK	<b>62</b>	<b>80</b>
<b>NPV benefit, including env. Costs</b>			
Society	Mill.DKK	60	103
District cooling business	Mill.DKK	17	52
Consumers	Mill.DKK	5	8
Internal rate of return	%	13	41

Figure 41 (derived from the GIS model) shows the location of grids and plants

- Green building: DC plant with cold water storage tank
- Red pipes: Existing DH pipes
- Blue pipes: Planned district cooling pipes
- Light blue pipes: Planned connection from the DC plant to the treated wastewater

Figures 42 and 43 show more details of the district cooling plant and the chilled-water tank.



Figure 41. GIS illustration of the District heating and cooling (Source: Ramboll).

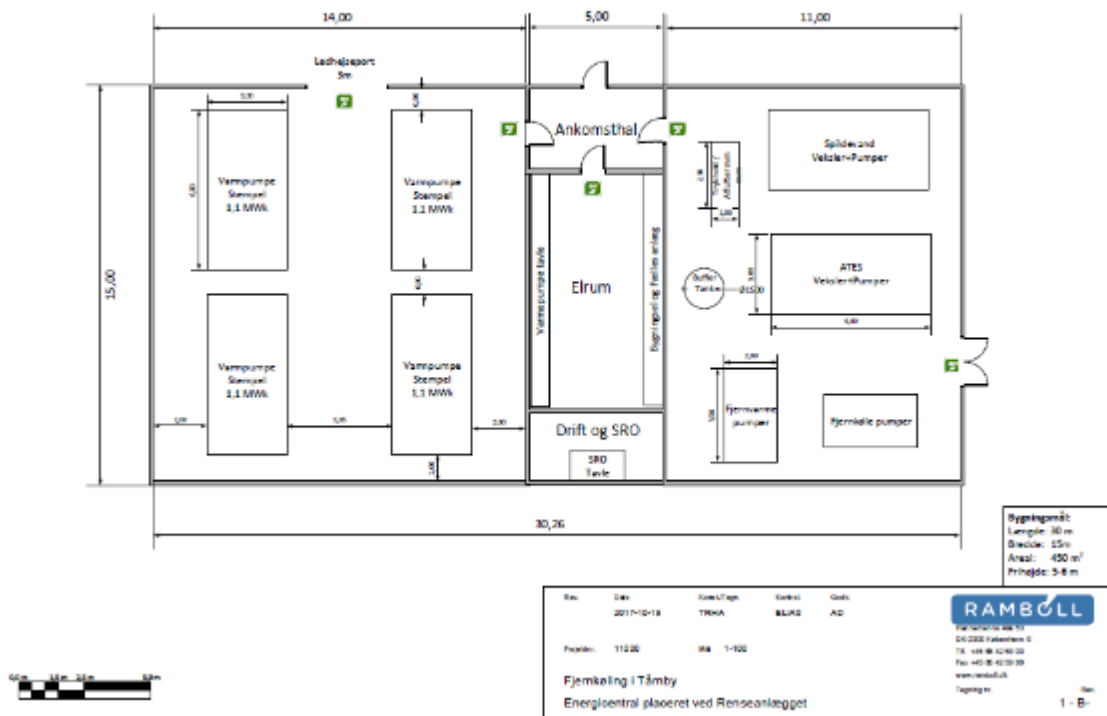

Figure 42. Map of the district cooling plant (Source: Rambøll).

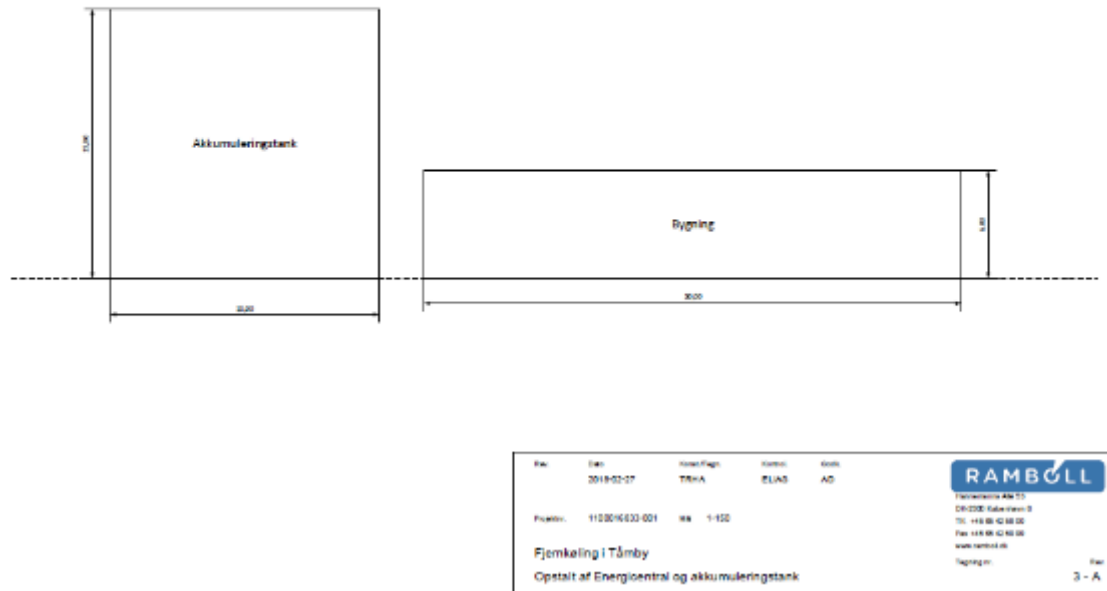

Figure 43. District cooling plant (Source: Rambøll).



## 6.7.3 Decision and Design Process

### 6.7.3.1 General/Organizational Issues

The project was initiated for several reasons:

- To integrate fluctuating renewable energy, heat pumps are becoming profitable in the district heating system and thereby in particular heat pumps, which deliver combined heating and cooling.
- Taarnby Public Utility has the overall objective to identify and implement the most cost-effective solutions for energy and environment for the population and companies in the owner-municipality.
- The building owners in the urban development area have an interest in environmentally friendly and cost-effective and reliable supply of cooling to meet new standards for indoor climate.

The major stakeholders were:

- The building owners, which can be supplied with cooling
- The public utility as a whole
- The district heating business unit serving the interest of all heat consumers, as all profit from heat supply is to the benefit of the heat consumers
- The heat transmission company CTR, which has an interest in optimal operation of the heat pumps for generating heat and to see the heat pumps as one of the first large-scale demonstration projects for heat pumps in the district heating system
- The national power grid company has a natural interest in heat smart electricity consumption, from large heat pumps, which can be optimized due to the storage and thereby reduce critical load on the power system.

Which stakeholders were involved in the project?

*The first four mentioned stakeholders were involved.*

Which resources were available before the project? What are local energy potentials?

- *By a fortunate coincidence, the wastewater treatment plant was located just next to the development area and owned by the utility*
- *There is a potential for extending the system, as there is a potential for ground source cooling in the coastal area and from a park just next to the plant*
- *The low temperature district heating system can be supplied with around 75 °C, which is a reasonable supply temperature for a two-step ammonia heat pump*

Who (what) were drivers and who (what) were opponents (barriers) – and why?

- *The utility was the driver*
- *An unforeseen barrier that created uncertainty was that it took a long time for the Energy Agency to accept the project, due to some outdated legal protection of heat from CHP plants*
- *It was difficult to create an open dialog with the two largest cooling consumers and their consultant, which had little experience in district cooling to establish comparable alternatives*

What have been the main challenges regarding decision finding?

*As it was a completely green-field project, the main challenges were parallel processing of:*

- *Formation of a legal business unit, due an outdated constrain in the Heat Supply Act, which prevents the district heating business to be responsible*
- *Negotiating letter of intent and later final contract with the biggest consumer, which was a precondition for guaranteeing the project*
- *Financing of the initial investment, as there is no cash flow in the new cooling business unit.*
- *Accept from the Energy Agency, as explained above*
- *The design and agreement with CTR was not a challenge as the concept was known beforehand and that CTR had shown interest in using heat from the wastewater as a demonstration project.*

What was finally the crucial parameter for go /no-go decision?

*The design was completed during the process, but the following two parameters delayed the call for tender and the expected operation, as the delivery of heat pumps is the critical path:*

- *Acceptance from the Energy Agency*
- *Final signed agreement.*

### **6.7.3.2 Financing Issues**

The financing has been difficult as it is a new business unit, however an agreement with the consumers to pay upfront a connection fee, which is lower than the alternative investment but large enough to provide a reasonable self-financing of the project, was important.

Which business model applies to the project?

*The new district cooling business unit takes care of cooling business, whereas the district heating business unit takes care of the heat pump.*

*Thus, the public utility is responsible for all aspects of the project, which has been important for the planning and implementation. This model opens for maximal competition and use of market forces:*

- *District cooling competes with consumers' individual solutions.*
- *Heat production competes with the alternative heat production in the greater Copenhagen district heating system.*
- *The production of heat and cold is optimized with respect to the power market prices.*
- *There has been a tender for all services and components, as the public utility with assistance from consultant is project manager for the whole project and has staff for the operation. There has been tender for: consultancy services, building for cooling plant, cooling plant equipment, district cooling pipes, and district cooling civil works.*

### **6.7.3.3 Technical Issues**

What have been major technical challenges/constraints regarding system design?

*It has been a challenge to negotiate and agree on technical specifications for supply of cooling to the consumers.*

What solutions have been considered for generation, storage and load management?

*As the concept had been optimized in previous generic studies, it was not a problem to come closer to an optimal design of the plant. Considering all aspects and the time constraints, it was decided to establish the entire plant with storage for the final demand and thus install ground source cooling capacity in stage two, as this requires some critical decision-making with regards to environmental approval.*

### 6.7.3.4 Design Approach Applied

Which design targets have been set and why?

*The overall target has been to establish the most cost-effective system, which can be implemented and be cost effective as a standalone project, but at the same time be prepared being the most cost-effective solution in the long-term considering the potential. Moreover, accepting that the three first consumers wanted to have installed a production capacity from heat pumps, which meets their total subscribed capacity demand. Normally one would have reduced the heat pump capacity saving initial investment including:*

- *A realistic simultaneity factor of e.g., 0.9*
- *The capacity value of the storage tank*
- *The option of connecting a mobile peak load chiller, just in case.*

*However, as the heat pump capacity matched with the maximal capacity from the wastewater, it made good business to establish the total heat pump capacity from the first year.*

*Regarding the pipe technology, the district heating pipe technology with preinsulated steel pipes and good water quality without oxygen was preferred as alternative to Polyethylene High Density (PEH) pipes.*

*An important target has been to be ready to supply cooling for testing the installations at the first consumer. As this is impossible due to the long delivery time for heat pumps and the delays, the plan is to establish the network, the tank and the building in due time and then install a small temporary mobile chiller to load the storage tank, and from there deliver the needed capacity for testing the building installations.*

*Moreover, this installation for connection of a mobile chiller can remain and be an additional option for improving the security of supply and make the installation more resilient.*

*It was discussed with the consumers if it were necessary to establish emergency power generation at the chiller plant to be able to supply cooling in case of blackout, but it was not necessarily due to the huge reliability of the national power grid.*

Which tools have been used during the design phase? Include name, originate (plus web link), purpose of the tool, specific use of the tool within the case study, practical experiences during application, cost/price (if commercial tool)

*The hydraulic analysis of the district heating system has been executed by the hydraulic system SYSTEMRORNET and the existing model for simulating the district heating system to show that the heat can be fed into the system.*

*The hydraulic analysis of the district cooling system has been executed by the hydraulic system SYSTEMRORNET in a new model.*

*ArcGIS has been used to extend the existing GIS model with information of the district cooling to plan the route and connections to buildings.*

*ENERGYPro has been used to simulate the optimal operation considering the load fluctuations, the electricity price and the heat prices.*

*The data for flow and temperatures of the treated wastewater during a year has been based on the existing monitoring system of Taarnby Forsyning.*

*The business plan has been prepared by Ramboll's business plan model for district cooling*

What have been the main challenges in the design phase?

*It has been a challenge to streamline the temperature performance of the buildings, which should meet the standards of the building code, and to consider the design of the end-user*

*installations. In a campus, the campus owner would hardly invest in heat exchangers between the district cooling and the building installations, but in this case it seemed to be necessary due to institutional reasons rather than technical.*

#### What have been the most crucial interfaces?

*The most crucial interfaces have been:*

- *The temperature levels to and from consumers and thus the whole system*
- *The estimate of supply temperature demand for heat consumers, which will receive water from the heat pump at around 75 °C in winter*
- *The actual costs in the future for the alternative cost of heat (close to zero part of the summer and larger price in winter)*
- *The cost of electricity including taxes, as the Parliament had agreed on reducing the taxes on electricity for generation of heat*
- *The electricity tariff, which depends on the grid connection level and which should be reduced, as electricity can be disrupted in max load hours due to the chilled-water tank.*

#### What parameters are controlled via monitoring?

*Once the system is in operation in early 2020, it will be very important to monitor the total cooling demand hour by hour, which will be basis for analyzing capacity for connecting new consumers and for planning additional capacity.*

*Also the impact on the district heating will have to be monitored to reduce the supply temperature whenever possible.*

### **6.7.4 Resilience**

The district cooling system with four heat pumps and a chilled-water storage tank can offer a more resilient supply than individual chiller plants. Moreover, the district cooling system can more conveniently be prepared for connecting a mobile chiller in case of breakdown.

The system will be monitored and controlled by a SCADA system operated by Taarnby Public Utility.

The pipes to the consumers are significantly more reliable than the heat pumps and a leak in a pipe section can be identified repaired within a few hours.

One of the reasons for selecting the district heating technology (steel pipes with surveillance system) for the cooling pipes is that it can detect any leak and besides protect against corrosion from outside.

In case of substantial water loss, the storage tank will automatically be disconnected to avoid continuous water loss.

All pipes in this trench are close to the surface, which makes it possible to get access to pipes with short notice.

### **6.7.5 Lessons Learned**



So far, the project has been a success: however it is a frontrunner project in many ways and it has managed to pass several bottlenecks.

Therefore, it will be interesting to monitor and pass lessons learned to other district heating and cooling companies. With respect to this, Taarnby Forsyning is partner in a R&D project for the Danish District Heating Association with the aim to transfer lessons learned from heat pump projects to the whole sector.

The project has also demonstrated that a municipal-owned utility operating vital infrastructure in the municipality can identify the cost effective energy solutions in symbiosis with relevant sectors and implement them to the benefit of all consumers for heating and cooling, in fact acting like the whole municipality was one campus. Therefore, the case is a good story for campus owners.

In November 2020 the heat pump installation has been awarded by the European Heat Pump Association in in the DECARBINDUSTRY category of the #HPCY2020.\*

## 6.8 District Energy in Greater Copenhagen, Denmark

Case No.	Country	Location	Specific Type	Photo	Special points of attention
8	Denmark	Greater Copenhagen	Energy Supply System  District heat in a large city including 20 communities and many campuses		  district heating
<b>Country:</b>		Denmark			
<b>Name of city/municipality/public community:</b>		Greater Copenhagen Metropol			
<b>Title of case study:</b>		District Energy in Greater Copenhagen			
<b>Author name(s):</b>		Anders Dyrelund			
<b>Author email(s):</b>		<a href="mailto:ad@ramboll.com">ad@ramboll.com</a>			
<b>Link(s) to further project related information/publications, etc.:</b>		<a href="https://ec.europa.eu/jrc/en/publication/efficient-district-heating-and-cooling-markets-eu-case-studies-analysis-replicable-key-success">https://ec.europa.eu/jrc/en/publication/efficient-district-heating-and-cooling-markets-eu-case-studies-analysis-replicable-key-success</a>			

### 6.8.1 Background and Framework

In 1973, Denmark was totally dependent on imported oil, and the supply of oil to Denmark was restricted for political reasons. Therefore, the oil crisis of 1973 initiated a strong national

\*See:

<https://eur03.safelinks.protection.outlook.com/?url=https%3A%2F%2Fhpcy.ehpa.org%2F&data=04%7C01%7CAD%4Oramboll.com%7C26e2a12c77c9470580ba08d884c0ad48%7Cc8823c91be814f89b0246c3dd789c106%7C0%7C0%7C637405311400464078%7CUnknown%7CTWFpbGZsb3d8eyJWljojMC4wLjAwMDAilCJQljojV2luMzliLCJBTiI6Ikh1aWwllCjXVCI6Mn0%3D%7C1000&sdata=vJaiKgvTLu%2Bakh6Ph0cbmlaR02is3zDs7iDgGPSixE%3D&reserved=0>

energy policy with the aim to reduce dependency on oil based on several sources. Since the first national energy strategy in 1976, the Parliament has formed a stable national energy policy with the aim to develop a low carbon resilient energy in a cost-effective way for the society. The Electricity Act from 1976 and the Heat Supply and Gas Supply Acts from 1979 formed the basis in this transition. In the heating sector, the legal framework regulated the most cost-effective investments combining a new natural gas infrastructure with an extension of the district heating systems based on surplus heat from power plants and waste incinerators. The largest and most complex planning process for this integration of the two natural monopoly energy infrastructures for natural gas and district heating took place in Greater Copenhagen (Figure 44). The system was in operation in 1990 and has been extended to replace gas boilers and shift from steam to hot water in the city center. In 2019 district cooling has gained a minor market share in symbiosis with district heating, and the system is almost independent of fossil fuels.



Figure 44. The Greater Copenhagen District Heating System (Source: Ramboll).

## 6.8.2 Energy Objectives

The objective of the Heat Supply Act from 1979 was to replace oil in a cost-effective way for the society and increase energy efficiency and security of supply.

The overall national plan was to replace oil for heating by increasing the market share of district heating based on heat from CHP plants and waste incinerators and introducing natural gas for heating from a new national natural gas infrastructure.

Along with this national objective, the aim of the municipal and consumer-owned district heating companies was to ensure reliable heat at the lowest cost for the consumers.

The municipalities had the obligation to plan for the most cost-effective heat supply for the society of Denmark, acting as planning authorities in accordance with the Heat Supply Act.

### 6.8.3 The Planning Process for District Heating

The Electricity supply Act (1976) gave the Minister the power to approve all new power capacity. The Heat Supply Act (1979) gave the local governments the power and obligation to plan for heating in cooperation with the energy utilities, and initiated business plans and urban plans for cost-effective low carbon heating, including 20 municipalities in Greater Copenhagen.

Moreover, the municipalities established new municipal-owned district heating utilities to supplement the existing municipal and the consumer-owned distribution utilities and they formed two heat transmission companies to transmit heat from the existing and new power plants and take care of the optimal heat load dispatch.

Along with that, the Minister approved the new power capacity to Greater Copenhagen with heat and electricity, including a new power plant (Avedøre) at a new site close to the heat market.

Parallel to this, the municipalities formed a municipal-owned company to distribute natural gas in the municipalities from a new natural gas infrastructure based on Danish natural gas.

The heat supply planning, which divided the urban areas into district heating and gas zones, was in the first decade an interactive process including the Energy Agency, the region and all municipalities. The municipalities elaborated heat plans for district heating and for natural gas to be approved by the Minister, and the municipalities approved project proposals from the district heating utilities and the gas utilities.

Since 1990, the municipalities have been fully responsible for an ongoing heat supply plan to improve the heat supply whenever possible, according to their role as producer in the legal framework:

- The municipality is responsible for the heat planning and can recommend utilities to prepare project proposals in accordance with the Heat Supply Act.
- The municipality may elaborate a heat plan strategy or a strategic energy plan in case it is necessary to identify new project ideas and approve project proposals.
- The utilities elaborate business plans and identify project ideas, which can reduce the costs for the companies (which is to the benefit of the consumers), and which is cost effective for the society.
- The utilities elaborate project proposals (e.g., for extension of district heating to replace gas boilers or for construction of a biomass boiler) as single projects or as projects in accordance with their business plans and submit them for approval. The documents prove that the project is cost effective for the society compared to a realistic baseline and in accordance with price assumptions issued by the Energy Agency.
- All large heat consumers, e.g., large buildings and campuses, which have a total installed heat capacity larger than 250 kW, are considered as public utilities and must prepare a project proposal for approval in case the entity wants to establish a heat production that is not in accordance with the approved heat supply to the entity.
- The municipality sent the proposal for a public heating and direct heating to other utilities, e.g., the gas company.
- Stakeholders may complain.
- The municipality accesses the project proposal and considers any complains.
- The municipality approves/rejects the proposal, which can be appealed to the Appeal Board.
- The Appeal Board confirms or rejects the decision taken by the municipality.

### 6.8.3.1 The Institutional Set-up of the District Heating

The district heating system has been organized, based on Figure 44, as follows:

- The five municipalities in the central Greater Copenhagen formed the heat transmission company CTR (white color).
- The 12 municipalities in the western suburbs formed the heat transmission company VEKS (dark grey color).
- The waste management company Vestforbrænding, which was owned by 19 municipalities established its own heat transmission system and distribution systems to supply four more municipalities in the northern part of Greater Copenhagen (dark blue).
- Five of the municipalities who had a large potential for replacing oil boilers but no district heating established new municipal-owned distribution companies, including Tårnby Municipality in the central Copenhagen (see case on Tårnby).
- The power companies established two new coal-fueled CHP plants, approved by the Minister in Accordance with the Electricity Supply Act: an extension of Amagerværket AMV3 and a new power plant Avedøreværket at a new site close to the heat market in the western suburbs.
- CTR and VEKS established an integrated hot water heat transmission system (max 110 °C, 160 km, 25 Bar), to transmit all heat from existing and new power plants, waste incinerators, including the Vestforbrænding and any other competitive heat source to all distribution networks in the most cost-effective way. Moreover, CTR and VEKS took care of providing all distribution systems with resilient heat production capacity from all existing and new competitive plants.
- The distribution company HOFOR, owned by Copenhagen Municipality, operated an old steam system in the central part of Copenhagen and is in the process for converting the steam to hot water district heating, which will improve resilience and efficiency.
- CTR, VEKS, and HOFOR established a heat market unit being responsible for the optimal planning and operation of the system in cooperation with the power utilities.
- The almost 20 municipal- and consumer-owned distribution companies took care of the most cost-effective distribution to end-users and for operating existing peak boiler capacity, which was rented to the heat transmission companies.
- Thus, the sales price for heat from transmission companies to distribution companies includes all costs of pooled heat production and capacity.

The result of the legal framework and the institutional set-up is that the Greater Copenhagen District heating is planned, implemented, and operated as if it were one big campus.

### 6.8.3.2 The Planning Methodology for District Heating

An outcome of the legal and institutional framework is that there is no single planning entity in the system. There are more than 20 district heating companies, who plan investments that can improve their heat supply, e.g., extending the network to replace gas boilers, new transmission lines or new production capacity. The two criteria for each investment project are:

- It must be cost effective for the utility and thus reduce the heat tariff to consumers in the long run, giving the current market prices to be approved by the board of the utility.
- It must be cost effective for the society in accordance with the guideline from the Energy Agency to be approved by the local authority.

Thus, investment projects are only implemented when both criteria are fulfilled. Accordingly, if the utility accepts a solution that represents its own best interest, but the solution cannot be approved, then they must accept the next best solution that benefits both parties, i.e., to not sub-optimize at the level of the energy business of Denmark.



The typical methodology for supply of district heat to new districts used by the utilities and their consultants, who are specialized in the planning is the following:

- Mapping of geographical data and demand:
  - All relevant geographical information about the urban areas, landowners' registry, and other service lines are made available on electronic form for the supply area, which can be divided on districts based on a logic priority and characteristics.
  - All relevant information from the building register, including floor area, building category and age is available.
  - The annual heat demand can be estimated based on key figures.
  - The annual sale of gas or oil to clusters of buildings, e.g., for each road can also be made available from the building register, as all suppliers must report sale of energy to a national energy database.
- Network design:
  - A realistic trench for the service pipes is estimated.
  - Realistic supply temperature and return temperatures are defined based on the long-term production and the energy performance of the buildings.
  - The available existing and new production capacities are identified.
  - A hydraulic model is used to design the network considering the available pressure, demand and temperatures.
- Production of heat to new districts:
  - The annual heat losses of the network are estimated based on verified key figures to estimate the total production demand.
  - The maximal capacity demand is estimated based on experience from similar groups of consumers considering simultaneity.
  - The load dispatch is estimated considering the annual load fluctuations, the available production capacity, heat storage capacity and capacity constrains in the network (if any).
- A cost-benefit analysis (CBA) model includes the following data, analysis, and results:
  - Heat demand, cost of heat substation and cost of baseline supply for each consumer (building or campus)
  - Heat losses of networks
  - A forecast for development of the network and for connection of consumers to the network
  - Investment of all new networks and branch lines
  - Investment in all new production facilities
  - Cost of operations and maintenance (O&M)
  - Cost of heat generation in two sets of prices, one including
    - \* Environmental emissions.
    - \* Economic assessment at the level of the society of Denmark: calculation of NPV benefit of the investment scenario compared with a realistic baseline scenario for a period of 20 years and 4% discount rate based on energy price forecast issued by the Energy Agency including environmental cost of emissions, cost of CO<sub>2</sub> emissions (for the assessment by the planning authority).
    - \* Economic assessment at the level of the local community: The same calculation including all costs for the local community including all stakeholders in the local community but based on actual commercial energy prices including taxes on energy and based on a realistic discount rate, e.g., real interest rate on loans plus 1-2% for financial security (for the local community, e.g., the city council).
    - \* Division of the total benefit for the local community on all major stakeholders based on a realistic competitive set of internal prices, e.g., sale of heat from distribution company to consumers (for the assessment by the management of

the company and for negotiation with other stakeholders on internal prices, in particular between district heating company and large consumers, e.g., campus owners, who may have local backup capacity or surplus heat sources available).

- \* A financial projection in prices of the year for the district heating company including depreciation, financial sources and actual interest on loans (for the final decision by the board of the company for negotiating the financial conditions with banks).

### 6.8.3.3 The Planning Methodology for District Cooling

The market for active comfort and process cooling is growing in Denmark (and internationally). District cooling is a rather new business opportunity for the district heating companies in the region. District cooling has been implemented on a small scale compared to the district heating, but the market is growing due to the benefits of combining heating and cooling, and due to the fact that large heat pumps will play a major role in the future for integrating the fluctuating wind energy. The supply of district cooling is not regulated but can be delivered by the district heating companies to consumers on commercial conditions. This opportunity will increase the profitability of district heating projects both for the society and for the district heating companies. Thus, the planning of district cooling is like the business planning of the district heating, except that the dialog between district heating company and the large consumers, e.g., campuses, is even more important.

## 6.8.4 Project Technical Information

### 6.8.4.1 Heat Supply

There is no single source for all data to the system, as it is developing in time and space. Recently, the system been interconnected with two heat transmission systems north of the main area (Figure 44) via the transmission system of Vestforbrænding. Thereby surplus heat capacity from the waste incinerators can be transmitted long distance to cover the base load.

The data listed below is derived from an estimate for the system, which includes the conversion of the steam system to hot water supply in 2022, including all heat supply from CTR, VEKS, HOFOR, and Vestforbrænding.

The total population that is supplied by the interconnected system is roughly 1 million people; the total heated supply area of all connected buildings is around 70 million m<sup>2</sup>, and 98% of all buildings in the district heating zones are connected to network. The total heat sale to buildings is close to 9,500 GWh/a, and the total production of heat is 11,000 GWh. Thus, the total network losses are around 15%, of which 1% is in the transmission system.

The total production is divided into the following main sources:

- Waste incineration, mainly in CHP mode 30%
- Biomass CHP, partly with flue gas condensation 65%
- Peak and spare capacity from boilers 5%
- Heat pumps, mainly in combination with cooling <1%.

The peak and spare boilers is a mix of electric boilers, wood pellet boilers and gas/oil boilers.

It is difficult to estimate the fuel resources for generating the heat, as it depends on the baseline.

- For an overall heat and power sector, we notice that heat and electricity are generated using waste and biomass as an alternative to gas boilers and coal-fueled condensing plants; this waste and biomass otherwise be landfilled or would degrade to CO<sub>2</sub> with huge thermal losses, which would negatively impact the climate.
- For the heat sector alone, compared with biomass power-only plants, we notice that the 11,000 GWh heat can be generated efficiently using roughly 4,000 GWh of additional biomass and waste while at the same time using 7,000 GWh wasted energy, which would otherwise be lost in cooling towers or landfills. That would correspond to a total system efficiency of  $9,500/4,000 = 240\%$  (CO<sub>2</sub> neutral heat and efficient use of biomass).

In the coming decades it is expected that the market share of heat pumps and electric boilers will increase significantly. Around 2030, the oldest of the biomass CHP units will have worn out; it is more likely that a total capacity of at least 200 MW heat pumps and 500 MW electric boilers plus more heat storage capacity will have been installed as an alternative to reinvestment in the CHP plant. Moreover, the assets of the CHP plant could also be used for large heat pumps and electric boilers.

#### 6.8.4.2 District Heating Network Construction

Many of the transmission lines are constructed with preinsulated bonded pipes with welded muffs, but some of the trenches in the city center are constructed with insulated steel pipes in concrete ducts and steel-in-steel (Figures 45 and 46). All pipes are located underground, except for a few meters where the trench must cross highways, railroads, or heavily trafficked roads.

Most heat exchanger stations and booster pump stations in the city are located underground.



Figure 45. District heating pipe construction, with curved pipes(left) and straight pipes (right) (Source: Ramboll).



**Figure 46. Installation of preinsulated twin pipes of supply of small buildings (Source: Ramboll).**

Waste incinerators form a priority base load for heating (Figure 47). There are three waste incinerator plants, Vestforbrænding, ARC and ARGO (KARA/NOVEREN). The total capacity of the three waste incinerator CHP plants is roughly:

- 160 ton/hour for treatment of municipal and industrial waste
- 1.3 million ton/year, which is not deposited on landfills
- 420 MW heat capacity in CHP mode with flue gas condensation
- 120 MW electric capacity in CHP mode
- Average total efficiency around 100% based on lower calorific value
- 3,400 GWh heat production.

The waste is collected from most of the region and only roughly two-thirds of the waste is from the municipalities that are supplied with the heat from the plants.



**Figure 47. The newest waste incinerator ARC (Source: Ramboll).**

Figure 48 shows the performance and flexibility of ARC responding on high and low power prices.

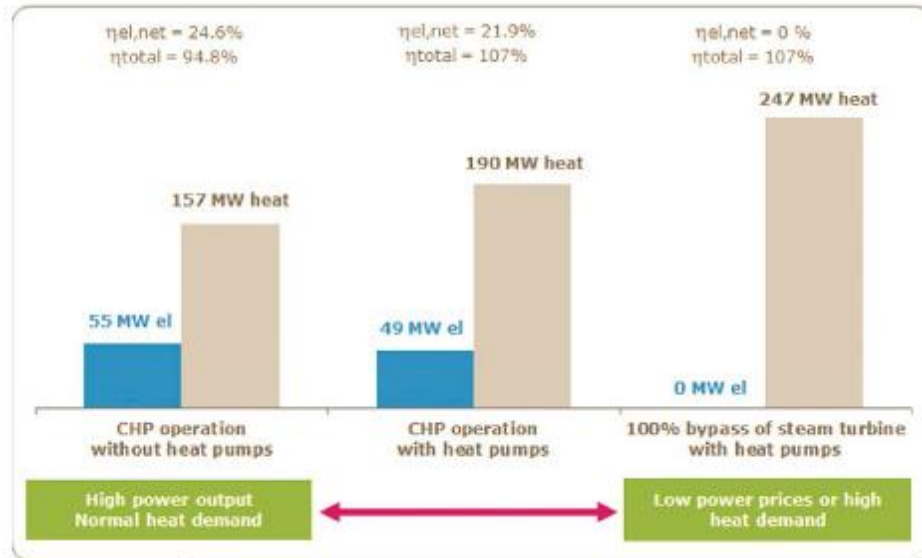

Figure 48. The operation flexibility and efficiency of ARC (Source: Ramboll).

### 6.8.4.3 CHP Plants as Base Load for Heating

Besides the waste-fueled CHP plants, which have priority, there are three base load CHP plants: Amagerværket, Avedøreværket and Køge CHPs, which are fueled with a combination of wood chips, straw, industrial waste wood, and wood pellets (Figure 49). Total installed capacity is:

- 770 MW<sub>e</sub> in back-pressure mode, some of the units can operate with turbine bypass
- 1600 MW<sub>th</sub> in back-pressure mode.

Moreover, there are installed gas-fueled power peak capacity, a 30 MW<sub>e</sub> gas-fueled CC plant at the Technical University Campus and 140 MW gas turbine as part of Avedøre Power plant. Total installed capacity is:

- 168 MW<sub>e</sub> in back-pressure and condensing mode
- 100 MW<sub>th</sub> in back-pressure mode.



**Figure 49. The Avedøre multi-fuel CHP plant with heat storage tanks (Source: Ramboll).**

Once the last coal-fueled CHP plant unit has been converted to wood pellets, all the base load production will be based on renewable fuels, except for the gas-fueled power peak capacity.

In the first stage of conversion from coal to biomass, wood pellets are most competitive because much of the installations can be reused, and because wood pellets can be handled like coal and fed into the boiler as dust.

The last new biomass-fueled CHP plant implemented a fluidized bed technology that allowed use of wet wood chips from the forest industry combined with flue gas condensation, which together increased the total efficiency of the CHP plant to around 110% based on the lower calorific value. The plant is designed with a steam turbine bypass, which allows the plant to operate heat only in case of surplus of cheap electricity.

#### **6.8.4.4 Hydraulic Design and Operation of the Transmission Network**

This transmission system (Figure 50) is owned and operated by CTR and VEKS. It includes more than 50 heat exchanger stations to distribution networks, and heat exchanger connections to Vestforbrænding (dark blue on the map above). The network diagram from the hydraulic model System Rornet includes a (planned but not yet approved) extension to some minor urban areas.

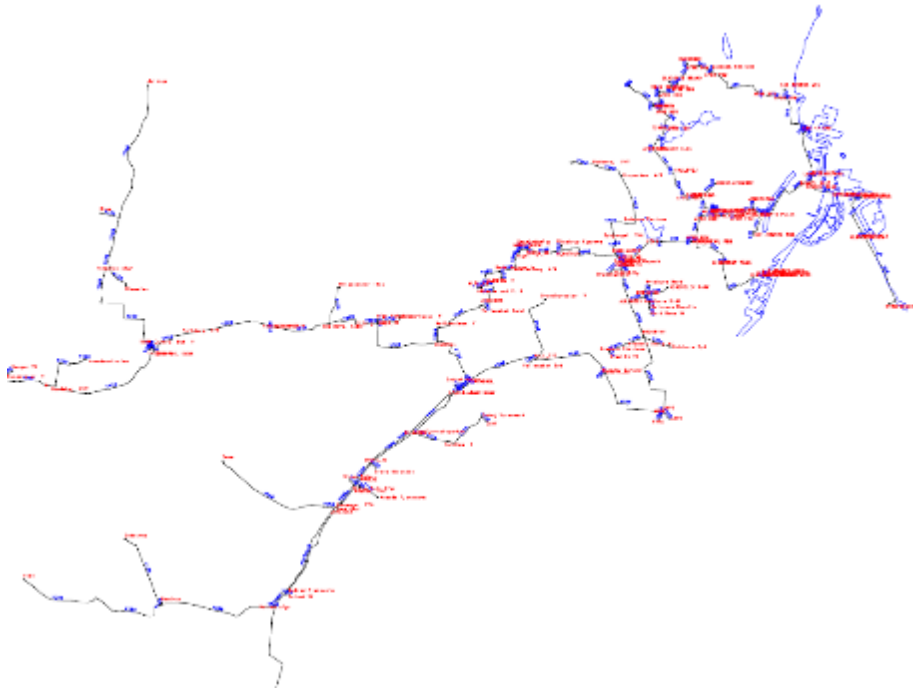

**Figure 50. District heating 25 bar transmission network from hydraulic analysis in all distribution systems (Source: Ramboll. Created with System Rornet).**

Figure 51 shows the pressure for critical lines, which illustrates how production and booster pumps are almost fully used and how the pressure is symmetric. The hydraulic pressure is in the hydraulic model restricted by a maximal supply pressure of 25 bar and a minimum of 2 bar. Besides, the maximal velocity in the large pipes is restricted to 3.5 m/s to reduce the risk of water hammering and corrosion.

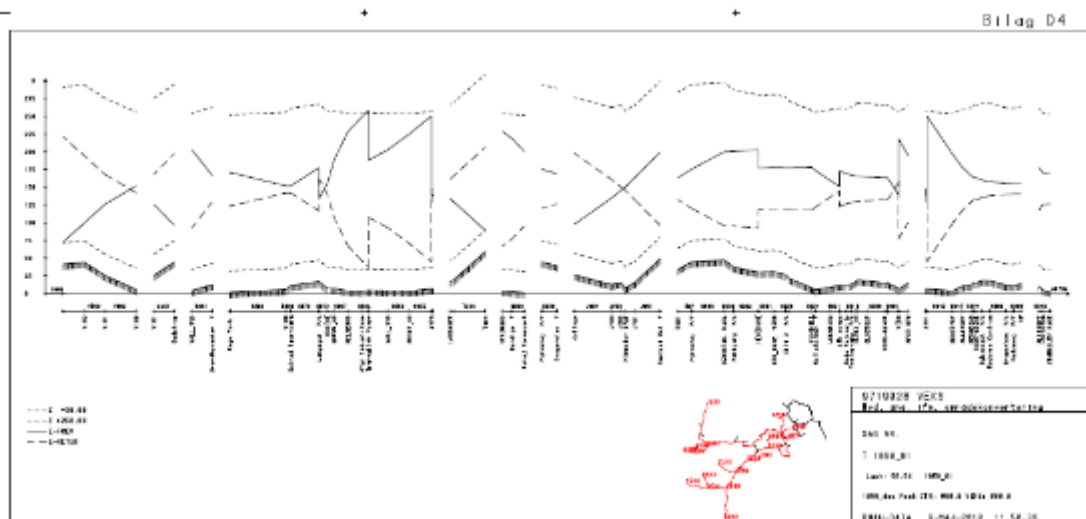

**Figure 51. Hydraulic pressure diagram for a typical critical load case for maximal transmission of all base load (Source: Ramboll, created with System Rornet).**

#### 6.8.4.5 Heat Storage Tanks

The technical data for the heat storage tanks is the following:

- Three x 24,000 m<sup>3</sup>, two at Avedøre CHP plant (Figure 52), and one at Amager CHP plant
- 120 °C Maximal design temperature (due to previous larger temperature demand)

- 110 °C Maximal operation due to hot water (low-cost) classification
- 10 Bar pressure section between tank and network
- 2 x 330 MW load and unload capacity, equal capacity at the two storages
- 3 x 1,300 MWh storage volume return temperature of 55 °C and 90% eff. Volume.



**Figure 52. Heat storage tanks at Avedøre CHP plant (Source: Ramboll).**

There is only one tank at Amager CHP plant, but the option exists to install one more to increase the maximal load/unload capacity of 330 MW from 4 to 8 hours like the storage tanks at Avedøre.

Figure 53 shows how the tank is separated from the pressure in the network by pressure reduction and pumps. This connection eliminated the temperature drop and reduces costs and it allows the storage plant to operate independently of the pressure head from the pump at the production plant.

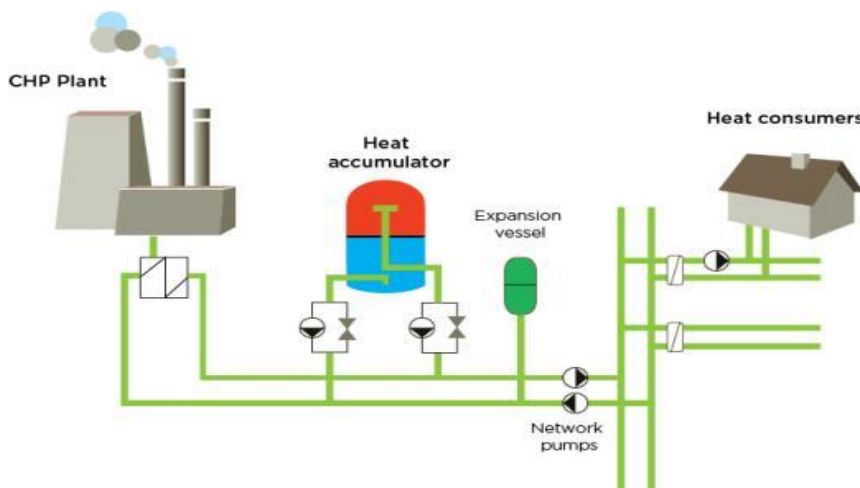

**Figure 53. Principle of operation of the heat storages tanks (Source: Ramboll).**

The network pumps control the differential pressure in the network and the pumps and valves at the plant controls the load/unload capacity. Note that Figure 53 does not show the pumps that control the flow and supply temperature from the CHP plant to the storage.

### 6.8.5 Technical Highlights

Several technical highlights of the project that are recognized by visitors are:

- The tunnel under the harbor 30 m below sea level in lime stone, which was the first of its kind in Denmark followed by several tunnels to more district heating and metro.



- The installation of the transmission system in the city districts with heavy roads.
- Establishment of a transmission system with practically no water losses and heat losses in pct. of transmission and with an unknown lifetime probably around 100 years for the main system, whereas the SCADA system, heat exchangers and pumps and main valves have been replaced within the first 30 years of lifetime.
- The distribution system has a long lifetime and low water and heat losses, typically from 5% to 15%, except for one single-family buildings that recorded losses of ~25%..
- The conversion from steam to hot water district heating in the city center.
- The ongoing transition towards lower temperatures in building heating installations and in the district heating, including transformation from super-heated water to hot water below 110 °C.
- The supply of district heating directly to buildings in a campus and to apartments in new multi-user buildings.
- The SCADA system and energy management system, which ensures optimal operation, automatization, and use of all necessary data.
- The advanced heat storage tanks with pressure sectioning.
- The flue gas condensation, which increases the production efficiency to up to 110% based on lower calorific value for the new biomass CHP plant.
- The way the major technical installations are integrated in the city environment, located at mainly two industrial sites.
- The way the newest waste incinerator, which set new energy and environmental standards, has become a part of the city; it includes a skiing slope on the roof, which has been instrumental in promoting the acceptance of several new apartment buildings to be built close to the incinerator.
- The integration of district heating and cooling.

## 6.8.6 Decision and design process

### 6.8.6.1 General/Organizational Issues

The project was initiated for several reasons, i.e., to implement the national energy policy objectives, in particular, to replace oil for heating with a combination of surplus heat from CHP and waste and natural gas in a cost-effective way for the society.

Who were the major stakeholders in the whole planning process?

- *The Ministry of Energy/ The Energy Agency for implementation the policy and to approve municipal plans for district heating zones and gas zones and for approving the CHP plants and waste incinerators*
- *The region for planning regional networks for district heating and gas, to secure way of right for the main lines*
- *The roughly 20 local governments in region, which could be included in the project as planning authorizes preparing plans for district heating and gas zones*
- *Some local governments for establishing new district heating companies*
- *The district heating companies, some owned by the municipalities and some owned by the consumers, to execute the district heating projects as project owners*
- *The power companies to establish the new CHP plants and heat storage tanks*
- *The gas company to supply district heating boilers with gas and to establish a regional gas grid and distribution grids to buildings in the natural gas zones*
- *The waste management companies to establish new waste-to-energy CHP plants*
- *The building and campus owners to invest in consumer installations for district heating.*

### Which stakeholders were involved in the project?

*To implement the district heating project including heat transmission and distribution networks, the following stakeholders were actively involved:*

- *Board of the companies elected by the consumers /or appointed by the city councils*
- *The management and staff of the district heating companies*
- *Road authorities and other owners of infrastructure in the public area*
- *Consultants to prepare heat plans, design of networks, tender documents and supervision*
- *Contractors to establish the networks and production plants*
- *Service companies to support with special technical services*
- *The banks and financial institutes to offer competitive financing of the investments*
- *Auditors to audit the financial accounting of the companies.*

### Which resources were available before the project? What are local energy potentials?

- *There was surplus heat capacity from existing CHP plants that could be used in an efficient way corresponding to an efficiency of 200-300%.*
- *There was surplus heat in the summer period from waste incinerators, which could be used, and new waste incineration capacity that could be fully used and thereby avoid landfilling and cooling of surplus heat.*
- *New power capacity had to be established in Eastern Denmark; this represented an opportunity to establish this capacity close to the heat market in Greater Copenhagen instead of using other power plant sites with no heat market. Thereby the new coal-fueled plants could be designed in an optimal way for combined heat and power and thus the efficient of using heat from this new plant would correspond to an efficiency of roughly 300%. (extracting 100 MWh of heat would cost 33 MWh of more fuel input and reduce the thermal losses from power plants in the system by 67 MWh).*
- *The use of combined heat and power in this system and in local district heating systems have reduce the power only generation with thermal losses to less than 20% of the total thermal power generation.*
- *There is no deposit of waste that could be used for recycling energy.*

### Who (what) were drivers and who (what) were opponents (barriers) – and why?

- *The Energy Agency could see this solution as a major step towards meeting the energy policy objectives.*
- *The air quality would be significantly improved by replacing many oil boilers with heat from large CHP plants with flue gas cleaning and replacing heavy oil with gas at district heating peak boilers.*
- *In the beginning, there was a conflict between the municipalities about access to the cheap heat capacity from the CHP plants and sharing investments in the heat transmission system; however, this was resolved by an agreement that divided the municipalities into two groups, one for the central densely area and one for the suburbs and by dividing the new power capacity in two plants*
- *The gas project was approved by the parliament as an important instrument to increase the resiliency for the whole Danish energy sector although it was not cost effective. Therefore, it was a challenge for the Ministry of Finance to find solutions for paying for this investment. One of the solutions was to give the gas project a larger market share of the heating, including the northern suburbs of Copenhagen and the zoning between gas and district heating was a political issue. Copenhagen municipality wanted, for example, district heating to all buildings to serve the interest of the population whereas the Ministry wanted to give the gas a market share in Copenhagen.*

- *Based on long experience, the consumers and the municipalities have found it most profitable for the local community, campuses, and consumers to be project owners and thereby to benefit from the market forces by outsourcing services to commercial companies such as consultants for planning and design, suppliers to deliver equipment, contractors to install, service companies to maintain special components, and (not least of all) banks to compete to offer the lowest interest rate for loans financing 100% of the investment.*
- *Recently the financial sector and some private entities have shown an interest in being owner of this natural monopoly infrastructure. Although this is prevented by the present Heat Supply Act, a new regulatory system of maximal prices has been introduced to help the regulator to regulate in case of private ownership.*

What have been the main challenges regarding decision finding?

- *The first challenge was to agree on where to establish the new hot water CHP capacity.*
- *The second was to agree on the zoning of the transmission system. Some municipalities in the northern part and southern part were, for example, not included in the first stage in 1985 but included 25 years later.*
- *The third challenge was to agree on the detailed zoning between the district heating and gas in all the municipalities. Many industrial areas were, for example, planned for natural gas in 1985, but 20-30 years later, converted to district heating.*
- *The rather large steam system in the central part of Copenhagen and Frederiksberg were not included in the planning because they were already supplied from CHP plants based on coal and gas; however the conversion to hot water district heating has been ongoing since year 2000 and will be completed in 2022.*
- *It was also a challenge to speed up the connection of oil boilers to district heating and gas, not only for this project, but for all projects in Denmark, as maximal connection to the grids was an opportunity for increasing the profitability for the society of Denmark. Therefore, the Parliament decided that all buildings or campuses with a capacity above 250 kW should connect to the planned heat supply grids within 1 year. The Price Commission also decided that the cost of district heating and gas in that case should not exceed the cost of oil.*
- *The local governments could also decide that all smaller buildings should connect within 8 years and that new buildings should connect.*

What was finally the crucial parameter for go /no-go decision?

*The crucial parameter was the political agreement between the Ministry and all municipalities on approval of the new CHP capacity and at the same time agree on how to share the surplus heat capacity from both the existing and new capacities.*

### **6.8.6.2 Financing Issues**

The Ministries being responsible for the financing and for the local governments ensured that all the municipal-owned companies for gas, heat transmission, and heat distribution could be established by the municipal-owned companies operating completely independently of the municipal budgets, because the consumers had to pay for all costs via tariffs. The Heat Supply Act specified that the heat price can include all necessary costs (and not profit for investors or municipal budgets). Therefore, the municipalities in fact own and operate the energy infrastructure for district heating on behalf of the consumers, with the aim of reducing costs to the consumers.

Moreover, the legislation allows the municipality to guarantee for loans obtained by both their own companies and by consumer-owned companies. Thus, all investments are financed 100% and the financial institutes and banks compete to offer the lowest interest rate on the world market.

Which business model applies to the project?

*The basis business model is that all district heating companies has the objective to deliver sufficient quality of heat at the lowest cost. This improves cooperation and exchange of information, as if it were one campus owner. However the basis business model is not as efficient as other models since it does not prevent building owners from suboptimizing.*

### **6.8.6.3 Technical Issues**

What have been major technical challenges/constraints regarding system design?

*The major stakeholders established a technical committee that assumed responsibility for the overall design and for defining the design criteria. It was agreed that the new district heating system should be very reliable and resilient and designed for a long lifetime (40 years or more) for the main components.*

*There were several technical challenges for the design of the heat transmission system meeting these criteria:*

- *The integrated system should be operated by two new heat transmission companies in cooperation with large producers*
- *Several large capacities at various locations should be able operate on/off feeding large capacities into the grid*
- *Around 20 distribution networks owned by district heating companies and campuses should be connected to the grid, and these networks had different design pressure and not all had fully controlled the water quality*
- *Many buildings had internal heating systems designed for 90 °C supply on the coldest day.*

*The solution was to establish a 25 Bar transmission system separated from the distribution grids with heat exchanger substations and designed as a hot water system (today maximal supply temperature 110 °C) and operated with symmetric supply and return pressure. Thus, in case of pump failure, the pressure would stabilize at the average pressure of 13 Bar.*

*Several other steps were taken to prevent water hammering, e.g., a small bypass on all stop valves and automatic regulation of the variable-speed-drive pumps.*

What solutions have been considered for generation, storage and load management?

*The overall solution has been to create this integrated system that will allow the companies to operate it hour by hour to use all available cheap and efficient heat generation in an optimal way. No boiler will, for example, be started before all the cheaper capacity is used.*

*To facilitate this the transmission companies established advanced SCADA system combined with optic cables for communication in such a way that all units can be controlled and operate locally in case of any failure of the central system. This system is staffed 24/7 by one control center for each transmission company and for each large CHP plants.*

*The production and has been considered in several steps from 1985 to 2019 in a transition towards more low carbon, resilient and flexible energy supply:*

- *Step1: Urgent use of existing surplus capacity from CHP and waste incineration, e.g., by construction of a tunnel under the harbor.*

- *Step 2: New CHP plants based on coal, gas, and straw replacing coal fueled power only capacity.*
- *Step 3: New CHP units based on waste replacing old units and meeting the demand for waste treatment and with steam turbine bypass.*
- *Step 4: Conversion from coal to wood pellets operating as extraction plants.*
- *Step 5: New CHP plant based on wood chip with turbine bypass.*
- *Step 6: Existing oil and gas-fueled boiler plants, which can offer 100% local backup are used as much as possible to save investments, and new peak capacity is established in a way to improve the resilience and integrate more fluctuating wind, e.g., large electric boilers combined with heat storages.*
- *Step 7: Large heat pumps, mainly for combined with district cooling and use of surplus heat from industries and datacenters as well as large electric boilers are being installed step by step once there is an opportunity, and the total capacity of heat pumps will in time replace re- investments in wood pellet CHP capacity.*

*Several benefits of establishing heat storage are, for example*

- *Established at the large CHP extraction plants, heat storage increases the flexibility of the plants unbundling heat and electricity, e.g., allowing the plant to stop heat generation in power peak hours and to gain maximal power capacity, and increasing the production in low load hours.*
- *Establishes at the CHP back-pressure plants, heat storage allows the plant to maximize the revenues generating more electricity at high prices.*
- *Heat storage levels the daily and weekly minor fluctuations of the heat supply, compensation for the fact that some consumers use night set-back.*
- *Heat storage levels the daily production on the coldest day and thereby offers heat peak capacity.*
- *Heat storage increases the production from the cheapest heat sources.*

*The following heat storage concepts have been installed or are in the pipeline:*

- *Large heat storage tanks 3 x 24,000 m<sup>3</sup> for 120 °C separated from the transmission grid with pressure section*
- *Large pressure-less heat storage tanks for 95 °C at the distribution grids*
- *Large underground heat storage pit for 85 °C at the distribution grids separated by heat exchanger.*

*The following load management has been implemented:*

- *The distribution systems operate with variable-speed-drive pumps to meet the demand of all consumers by controlling the differential pressure, and the consumers are in general encouraged to reduce their set-points for supply temperature and use their heating systems efficient by reducing the return temperature and avoiding unnecessary on/off regulation, e.g., night set-back. Most utilities encourage the reduction in the return temperature by, for example, introducing a tariff.*
- *The transmission and distribution systems operate the supply temperature in an optimal way, which can be lowest possible reduce the heat losses and production costs or it can be at a larger level to use the transmission capacity for the cheapest heat.*
- *The transmission companies and the largest distribution company HOFOR has established a neat market unit, which plan and optimize the heat production in weekly and daily basis based on forecast for demand and electricity prices and in dialog with the producers.*

#### **6.8.6.4 Design Approach Applied**

The design has been in accordance with the Danish and international standards mainly, e.g., allowing installation of the modern district heating preinsulated pipe technology including:

- welded muffs
- surveillance system
- fixed system without expansion loops and compensators
- curved pipes and twin pipes.

#### Which design targets have been set and why?

*The overall criteria have been to identify the most cost-effective solution, which at the same time meets the criteria of security of supply.*

*The criteria for maximal capacity demand for heating is in principle -12 °C and strong wind, and the criteria for total installed capacity has been based on actual measurements of the actual consumption hour by hour in winter periods forming a realistic max load hour value to characterize the total demand for all.*

#### **6.8.7 Resilience**

The system design with local backup plants and interconnection has established a very resilient system, which has proven to be very resilient with very few interruptions in the more than 30 year of operation.

One hospital has, for example, a large boiler plant 4 times larger than their own demand and the surplus capacity is sold to the district heating company.

Another hospital has no boiler backup, but has related to two branch lines, which can be supplied from each end of the network.

In case a pipe cannot be repaired within 24-hours, e.g., in case it is deep under a railroad, there is a backup boiler in the district, which can be interrupted or there is an installation for a mobile boiler.

Total installed peak capacity involves a typical resilience issue that is more political than technical:

- The overall criterion is that the installed capacity including contribution from heat storage tanks shall be able to meet the maximal demand in case the largest production unit is out of operation.
- A second criterion that has been considered is that the installed capacity must be able to meet the demand on a normal winter day in case the two largest units are out of operation.

#### **6.8.8 Lessons Learned**



The project demonstrates that district heating is a vital part of the urban energy infrastructure in a city like Greater Copenhagen interacting in a cost-effective way:

- with the power system (use surplus heat and capacity)
- with the gas system (optimal zoning of the heat market)
- with district cooling for combined heating and cooling

- with the waste sector for using heat from all waste in the region
- with the wastewater sector using heat from sludge incineration
- with wastewater for use of heat via heat pump
- with industries, e.g., data centers for use of surplus heat
- with the buildings/campuses, which can be supplied with cost-effective low carbon resilient.

Moreover, the project demonstrates that this can be executed to the benefit of the consumers in case the consumers or municipalities takes the responsibility as project owners and cooperate openly to the benefit of all local stakeholders and benefit from the market forces for all activities for which there is a market, e.g., fuels, electricity market, consultants, equipment, contractors, service companies and financing institutions

## 6.9 District Energy from Waste for Vestforbrænding, Denmark

Case No.	Country	Location	Specific Type	Photo	Special points of attention
9	Denmark	Vestforbrænding	Energy Supply System District heating in five suburbs		 district heating, waste-fueled CHP
<b>Country:</b>		Denmark			
<b>Name of city/municipality/public community:</b>		Greater Copenhagen Metropol			
<b>Title of case study:</b>		District Energy from waste			
<b>Author name(s):</b>		Anders Dyrelund			
<b>Author email(s):</b>		<a href="mailto:ad@ramboll.com">ad@ramboll.com</a>			
<b>Link(s) to further project related information/publications, etc.:</b>		<a href="https://ec.europa.eu/jrc/en/publication/efficient-district-heating-and-cooling-markets-eu-case-studies-analysis-replicable-key-success">https://ec.europa.eu/jrc/en/publication/efficient-district-heating-and-cooling-markets-eu-case-studies-analysis-replicable-key-success</a>			

### 6.9.1 Background and Framework

The oil crisis in 1973 initiated a strong national energy policy with the aim to reduce dependency on oil based on several sources and Greater Copenhagen suffered from problem with landfills. Municipalities in the northern suburbs of Copenhagen joined forces and founded the waste management company Vestforbrænding. The company established two waste-fueled boilers for super-heated water and a district heating system to heat a new hospital and large apartment buildings.

From 1980, Vestforbrænding took part in the heat supply planning and further developed the system to supply around 300 GWh to its own consumers; it was also connected to the Greater Copenhagen District heating system to ensure that all heat could be used. Around year 2000, two new waste-fueled CHP unites were established and Vestforbrænding started to develop the district heating system to supply up to 900 GWh to own consumers and supply 300 GWh to Greater Copenhagen system. Moreover, heat is transmitted to local district heating companies (Figure 54).



**Figure 54. The Greater Copenhagen District heating system.**

Vestforbrænding, which is part of Greater Copenhagen District heating, owns and operates its own district heating system, which is supplied from two waste-fueled CHP units with flue gas condensation, 180 MW heat and 40 MW electricity in CHP mode and 220 MW heat in bypass mode. Vestforbrænding also owns a gas combined CHP plant 33 MW elec./30 MW heat and a 40 MW electric boiler at the Technical University of Denmark. Vestforbrænding generates in total around 1200 GWh heat from 500.000 tonnes of waste per year and 300 GWh of electricity. Two 5 MW heat pumps are in the pipeline, one for combined heating and cooling and one from wastewater and a minor combination with cooling. A first priority is to supply around 900 GWh to consumers in own network; the remaining 300 GWh is delivered to the two heat transmission companies CTR and VEKS. Gas-fueled peak boilers deliver the remaining capacity.

### **6.9.2 Highlight: Heat Supply Planning**

From 1973 to 1980, Vestforbrænding developed its own district heating system in cooperation with the municipalities to supply super-heated water to a new hospital and mainly new urban developments. The super-heated water (165 °C) supplied heat to an absorption chiller at the hospital; however there was still too much heat in the summer period, which was wasted.

Only the transmission system to the hospital and some industries and apartment buildings was supplied with super-heated water, which was delivered via heat exchangers to hot water district heating in districts, to ordinary hot water consumers.

Beginning in 1980, Vestforbrænding joined the heat planning process in Greater Copenhagen. As a result, the first priority was to supply all surplus heat to VEKS to replace district heating oil boilers, whereas the districts north of Vestforbrænding with no district



heating was supplied with gas. It was based on a political decision, as it was urgent to replace oil boilers and to give a market to the new gas company.

In 1990 the production of heat had increased, and one more connection to CTR was established. At the same time CTR and Vestforbrænding shared a new 30 MW gas-fueled peak boiler, to deliver peak capacity to the expanding market supplied by CTR and spare capacity to Vestforbrænding to give first priority to the hospital, in case of breakdown of the transmission line from Vestforbrænding to the hospital.

Around the year 2000, the old waste-fueled boilers were replaced by two CHP units, and the hospital had replaced the absorption chiller with an electric chiller. Therefore, the supply temperature was reduced as much as possible

After 2000, the energy policy changed and the aim was to cost-effectively reduce the dependency of fossil fuels.

Even before this plan was implemented, Vestforbrænding launched a new business plan, "Energy Plan 2015," which identified a potential for increasing the market further from 600 to 900 GWh, replacing large individual gas boilers. Moreover, the plan included interconnection with two heat transmission systems north of Greater Copenhagen. Thereby it was possible to transmit surplus heat from waste to these systems in the summer period.

This business plan is almost implemented. The business model for a very successful extension of the network and for connecting more than 90% of the potential consumers from the first year was:

- To offer the district heating in districts with larger consumers for which district heating is competitive and has positive profitability for the society (a precondition for approval)
- To offer the connection free of any connection fee and including the consumer substation. Thereby the direct payback time for all consumers was zero years.
- Compensation to the gas company for lost contribution to the payback of network.

The major extension takes place in the Municipality of Lyngby-Taarbæk and includes supply of heat to the Technical University of Denmark (see case), and acquisition of the privately-owned gas combined cycle CHP plant at the Technical University campus.

The methodology and cost benefit analysis for extension of the network and for investing in new capacities are described in the case for Greater Copenhagen District heating system. The network map is shown on page 124 (see Figure 44).

The main elements were:

- Data from building register and gas company
- Geographic information
- Hydraulic analysis
- EnergyPromodelling of load dispatch
- Economic CBA model.

### **6.9.3 Objectives: Energy Plan 2035**

In 2020 Vestforbrænding submitted a new business plan for activities up to 2035 demonstrating the role of Vestforbrænding for implementing the national energy policy objectives of 100% reduction of fossil fuels.

The main pillars in the energy plan are:

- Continue efficiency measures for reducing costs in the long term
- Time dependent tariff and motivation tariff for lower return temperature
- Measures to reduce the return temperature at consumers, and to take over ownership and obligation to maintain all consumer substations
- Develop district cooling and heat pumps with ATEs in combination with other heat sources
- Further extension of the network
- A strategy for security of supply and resilience, as criteria for backup capacity, to:
  - Meet demand on the coldest day even in case of disruption of the largest production plant (one of the incinerators)
  - Provide local backup capacity to ensure not less than 24-hours disruption of heat supply to any consumer.
- A strategy for extension of the network to supply remaining districts, mainly terrasse houses and single family houses
- A strategy for supply of new low temperature buildings with 3-pipe connection etc.

In the long run (2030—2035):

- Carbon capture and use CCU combined with use of around 40 MW surplus heat and benefiting from access to CO<sub>2</sub> from waste continuously.
- P2X combining H<sub>2</sub> from electrolysis with CO<sub>2</sub> to form Renewable gas to the gas grid and combined with se of around 100 MW surplus heat.

#### 6.9.4 Project Technical Information

- District heating involves network construction (see Table 20).
- The total heat loss in the network is 9% of heat supplied to own consumers.
- The main DN500 transmission line from 1973 is insulated steel pipes in concrete duct and designed for 25 bar and up to 165 °C. It is still in good shape for a section that had to be moved due to construction of a new light rail.
- All new pipes from 1980 are preinsulated with welded joints and surveillance system.
- Heat was previously transferred to hot water (<110 °C) 10 or 16 bar via heat exchangers.
- Recently Vestforbrænding use instead shunt pumps and pressure reduction stations to minimize use of heat exchangers
- All end-user installations are however separated from the network with heat exchangers.
- Vestforbrænding also use curved pipes (see picture Figure 45 on page 129) and twin pipes.

**Table 20. Additional Information of the district heating network construction.**

<b>Temperatures in transmission typically:</b>	120/55, but being reduced year by year
<b>Typical temperatures in distribution:</b>	90/50
<b>Heat production from waste:</b>	1.200 GWh, of which 900 to own network and 300 to CTR and VEKS
<b>Heat losses in network:</b>	80 GWh
<b>Maximal peak capacity demand:</b>	300 MW
<b>Two waste-fueled CHP units:</b>	180 MW heat/40 MW power or 120 MW heat/0 MW power
<b>Gas-fueled DHP:</b>	30 MW heat/33 MW power
<b>Electric boiler:</b>	40 MW
<b>Heat pumps in the pipeline:</b>	11 MW
<b>Gas-fueled peak spare boilers:</b>	250 MW

Figures 55 and 56 show the supply areas and the potential for district cooling clusters.

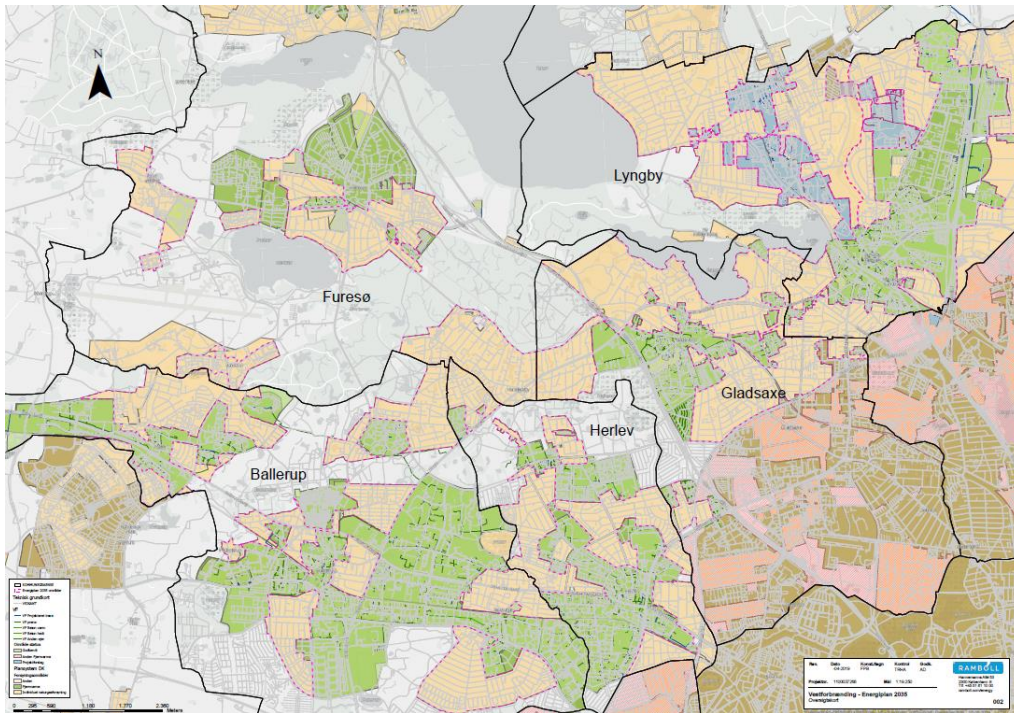

Figure 55. Supply areas for district cooling clusters.

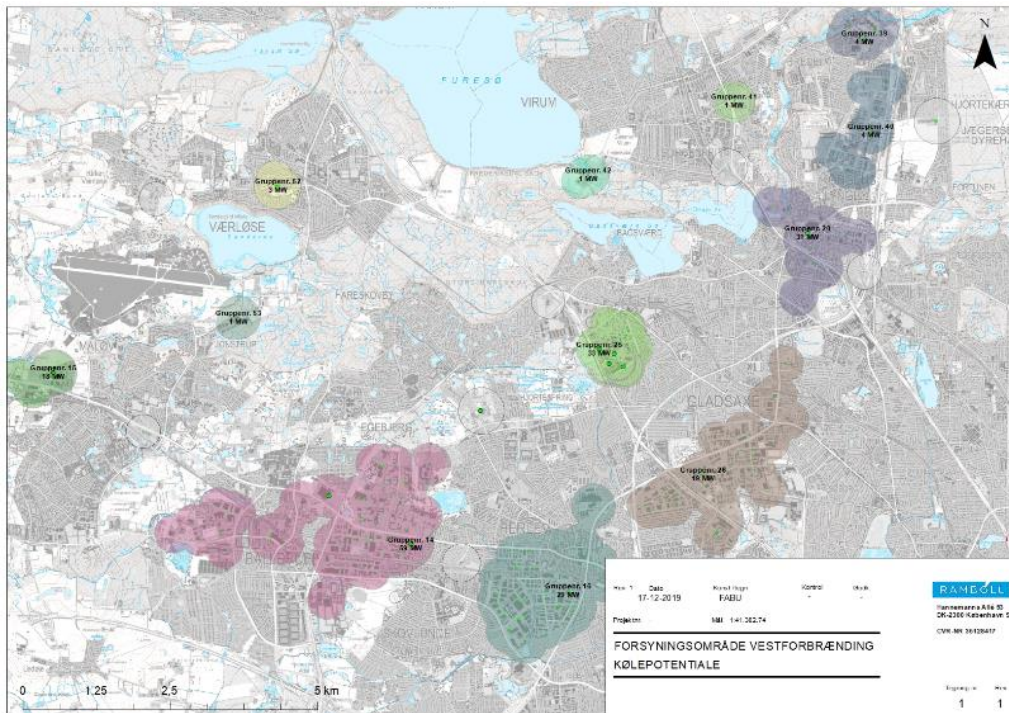

Figure 56. The potential for district cooling clusters.

Figure 57 and 58 show the current district heating network and one of the hydraulic load case for long distance transmission of heat.

The graph in Figure 58 shows that the capacity of the existing old network is increased significantly by introducing booster pumps and negative differential pressure in certain zones. Moreover, local peak boilers increase the use of efficient base load to new consumers.

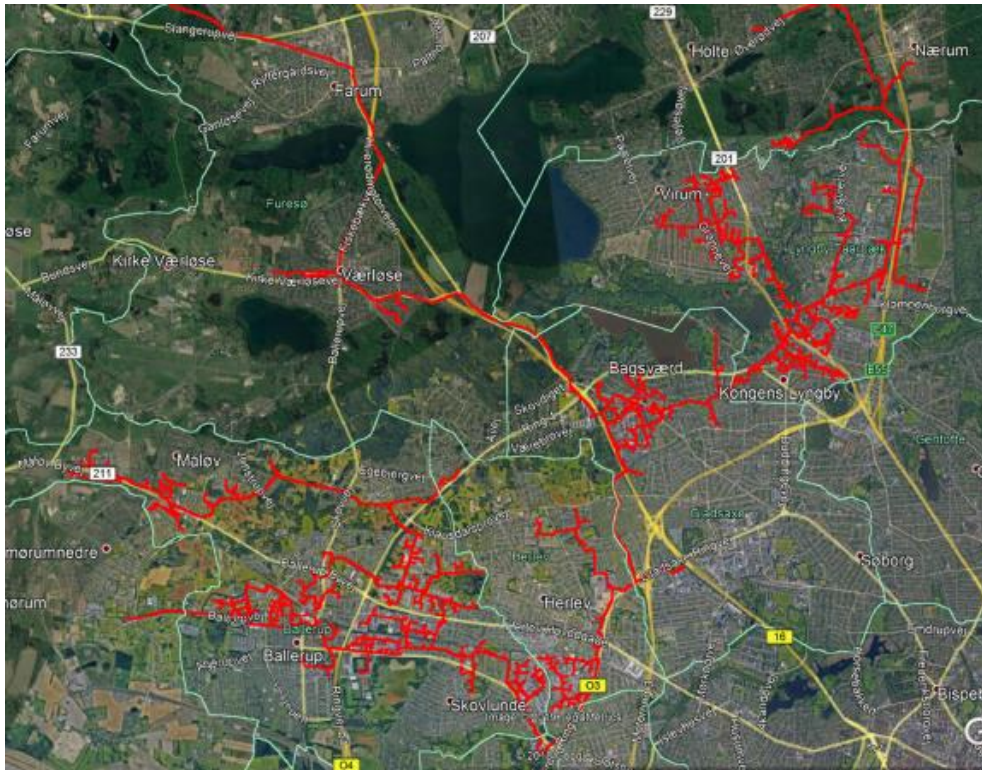

Figure 57. Current district heating network.

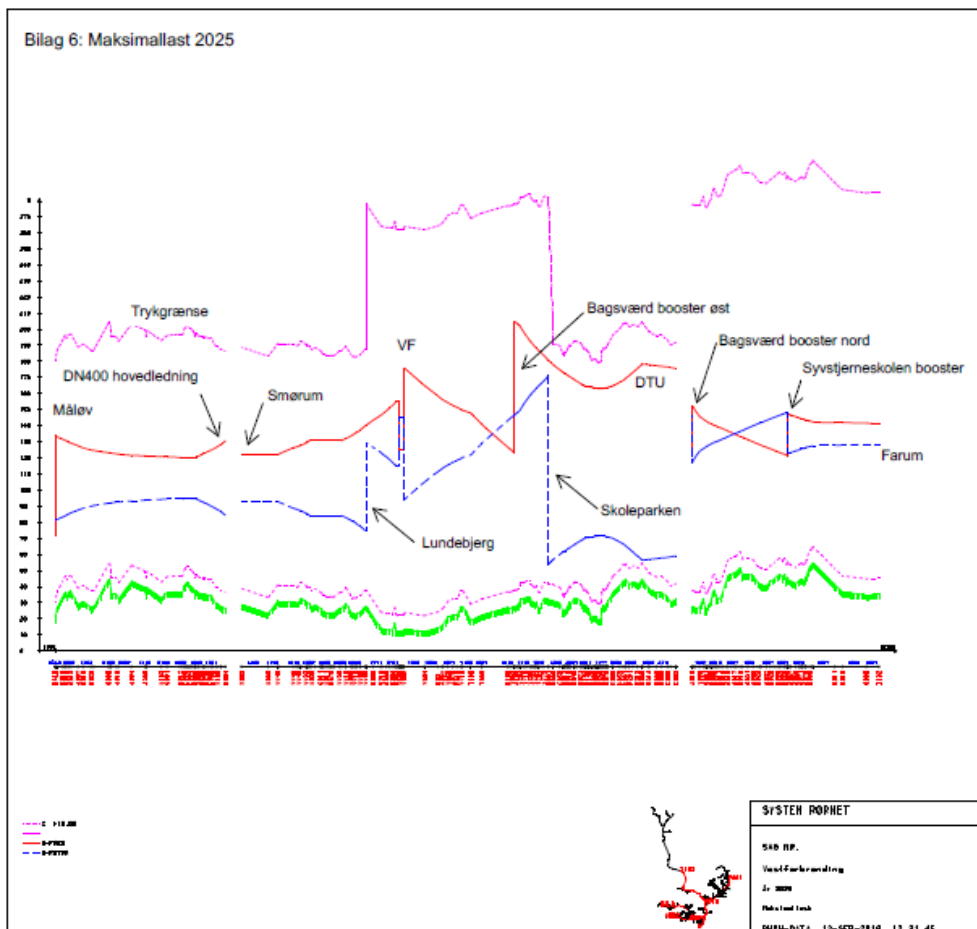

Figure 58. One of the hydraulic load case for long distance transmission of heat (Source: Ramboll, created with System RORNET).

Some of the technical highlights of the project that are recognized by visitors are:

- Almost all waste is recycled; the first priority is to reuse materials and the second priority is to reuse heat.
- Extension of the network to triple the use of low carbon heat from waste-fueled CHP plants to replace gas boilers.
- Response on the electricity price as:
  - CHP turbines can be by-passed with 40 MW in case of low prices.
  - The gas-fueled CHP plant at DTU, which now is owned by Vestforbrænding, can shift from 33 MW production to 40 MW consumption and optimize with 8,000 m<sup>3</sup> heat storage tank.
- The planned 5 MW heat pump using heat from wastewater treatment plant is planned to be located in an industrial area with potential for district cooling and the wastewater will be supplied via a 1.3 km pipe (similar to Taarnby district cooling).
- The new low temperature section of a 50 year old hospital with high return temperature will be connected with 3-pipe connection to reduce the return temperature from old high temperature system.
- Pressure reduction and shunts instead of heat exchangers.

## 6.9.5 Decision and Design Process

### 6.9.5.1 General/organizational issues

The project of waste heat recovery was initiated for several reasons, to:

- Reduce use of landfills to almost zero
- Recycle energy from waste
- For environmental reasons
- For lowering cost of processing waste
- For lowering the heat prices.

The project for extension from 300 to 900 GWh was undertaken to

- Lower heat price to existing and new consumers in the owner municipalities
- Meet the energy policy objectives of reducing dependency on fossil fuels.

### 6.9.5.2 Major stakeholders

Which stakeholders were involved in the whole planning process?

- *All the owner municipalities, who has appointed members to the board*
- *The owner municipalities, which could be supplied with heat*
- *Local district heating companies*
- *Large consumers like the Technical University of Denmark (DTU, see case)*
- *The gas company, in opposition*
- *The wastewater treatment plant*
- *The two other heat transmission companies VEKS and CTR.*

Which stakeholders were involved in the project?

- *Board of directors representing the owner municipalities*
- *The management and staff of Vestforbrænding*
- *Road authorities and other owners of infrastructure in the public area*

- *Consultants to prepare heat plans, design of networks, tender documents and supervision*
- *Contractors to establish the networks and production plants*
- *Service companies to support with special technical services*
- *The banks and financial institutes to offer competitive financing of the investments*
- *Auditors to audit the financial accounting of the company.*

Which resources were available before the project? What are local energy potentials?

- *There was surplus heat from waste incinerators most of the year that was sold to CTR and VEKS at a low price to substitute cheap heat from the biomass CHP plants.*
- *Capacity of the existing system could be increased by increasing velocity and reducing the return temperature from consumers*

Who (what) were drivers and who (what) were opponents (barriers) – and why?

*The gas company has been in opposition, but had to accept projects, which were profitable for the society and should be approved in accordance with the Heat Supply Act.*

What have been the main challenges regarding decision finding?

*To find a political agreement that the gas company should accept to close supply to large consumers and get a compensation covering lost fixed payment for infrastructure.*

What was finally the crucial parameter for go /no-go decision?

- *The crucial parameter was for all projects that Vestforbrænding could prove that each of the projects was profitable for the society.*

### **6.9.5.3 Financing Issues**

- *The business plan demonstrated that each of the projects were profitable and “bankable,” that the heat consumers would connect*
- *Records demonstrated that the heat consumers could pay all the bills.*
- *The owner municipalities could guarantee for the loans.*

Which business model applies to the project?

- *The objective of the district heating business is to minimize the price for the consumers in the owner municipalities*
- *The offer to the new consumers is adjusted to increase demand, which increases the positive response and thereby enhances the cost effectiveness of the projects.*
- *Vestforbrænding has better option for obtaining loans than many consumers and invest in a long-term perspective of 30 -40 years, whereas many commercial consumers only plan 7 years ahead.*

### **6.9.5.4 Technical issues**

What have been major technical challenges/constraints regarding system design?

- *To consider if it were feasible to connect a high temperature consumer, which had 60 °C return temperature in a district in which there were capacity problems in the network (later the consumer found the fault and could reduce to less than 50)*
- *To plan the construction work and coordinate with road authorities in a municipality that was not accustomed to district heating.*

#### What solutions have been considered for generation, storage and load management?

- *The overall plan is to optimize considering load fluctuations of the waste heat and heat demand as well as electricity prices.*
- *A small heat storage tank is in the pipeline for regulating the load dispatch.*
- *A larger storage tank or pit storage is considered.*
- *The 8000 m<sup>3</sup> tank at DTU will be fully used for integrating heat from CHP only at large electricity prices and the electric boiler at low electricity prices.*
- *in Energy Plan 2035 Vestforbrænding may have 11 district cooling clusters, most of them with chilled-water tanks and ATES and combined with surplus heat from wastewater, datacenters and industry.*
- *By 2035, Vestforbrænding is considering the possibility of hosting a CCU and P2X.*

#### **6.9.5.5 Design Approach Applied**

The design has been in accordance with the Danish and international standards mainly, e.g., allowing installation of the modern district heating preinsulated pipe technology including:

- welded muffs
- surveillance system
- fixed system without expansion loops and compensators
- curved pipes and twin pipes.

#### Which design targets have been set and why?

*The overall criteria have been to identify the most cost-effective solution, which at the same time meets the criteria of security of supply.*

*The criteria for maximal capacity demand for heating is in principle -12 °C and strong wind, and the criteria for total installed capacity has been based on actual measurements of the actual consumption hour by hour in winter periods forming a realistic max load hour value to characterize the total demand for all.*

#### **6.9.6 Resilience**

The system design with local backup plants and interconnection has established a very resilient system, which has proven to be very resilient with very few interruptions in the more than 30 year of operation.

One of the largest consumers is a hospital that has no boiler backup boiler, but Vestforbrænding has connected the hospital with a branch that can be supplied from each end of the network, either the waste CHP or a peak boiler, which Vestforbrænding shares with the CTR transmission company. The boiler is in normal operation supplying CTR with peak load, but in case of interruption of the supply from the waste CHP, the hospital has first priority.

If a pipe cannot be repaired within 24-hours, e.g., in case it is deep under a railroad, there is a backup boiler in the district that can be interrupted or there is an installation for a mobile boiler.

Therefore, a 24 MW peak boiler was located on the other side of a deep railroad crossing with a DN400. A few years later actually a drilling damaged one of the pipes, and the backup boiler had to operate for several weeks.

The main criteria is that there be enough capacity if the largest unit were to shut down. It was considered unlikely that both units would be out of operation at the same time. However, in one cold December, a fire in some cables to the control center took both units offline for several weeks. Vestforbrænding managed to keep all consumers warm, but it was close to a deficit.



### 6.9.7 Lessons Learned

The Vestforbrænding project demonstrates that district heating is a vital part of the urban energy infrastructure in a city like Greater Copenhagen that cost-effectively interacts:

- with the power system (use surplus heat and capacity)
- with the gas system (optimal zoning of the heat market)
- with district cooling for combined heating and cooling
- with the waste sector for using heat from all waste in the region
- with wastewater for use of heat via heat pump
- with industries, e.g., data centers for use of surplus heat
- with the buildings/campuses, which can be supplied with cost-effective low carbon resilient.

Moreover, the project demonstrates that this can be executed to the benefit of the consumers in case the consumers or municipalities takes the responsibility as project owners and cooperate openly to the benefit of all local stakeholders and benefit from the market forces for all activities for which there is a market, e.g., fuels, electricity market, consultants, equipment, contractors, service companies and financing institutions

### 6.10 University Campus of Technical University of Denmark (DTU), Denmark

Case No.	Country	Location	Type specific Type	Photo	Special points of attention
10	Denmark	DTU Close to Kopenhagen	Campus District heating and cooling in a University campus		  district heating and cooling
<b>Country:</b>		Denmark			
<b>Name of city/municipality/public community:</b>		Technical University of Denmark, Lyngby-Taarbæk Municipality, Greater Copenhagen			
<b>Title of case study:</b>		DTU, Campus Energy, DH&C and microgrid			
<b>Author name(s):</b>		Anders Dyrelund			
<b>Author email(s):</b>		<a href="mailto:ad@ramboll.com">ad@ramboll.com</a>			
<b>Link(s) to further project related information/publications, etc.:</b>		<a href="https://ec.europa.eu/jrc/en/publication/efficient-district-heating-and-cooling-markets-eu-case-studies-analysis-replicable-key-success">https://ec.europa.eu/jrc/en/publication/efficient-district-heating-and-cooling-markets-eu-case-studies-analysis-replicable-key-success</a>			



### **6.10.1 Background and Framework**

The Technical University of Denmark moved to a new campus site in the 60s (Figure 59) and established an infrastructure. All buildings were connected by walkable tunnels, which included vital parts of the infrastructure, including a heating network and a power grid owned by the university.

In the first stage, the heat was generated by 3 x 10 MW heavy fuel oil boilers and all power was supplied from the grid. Around 1985, the power utility established a coal-dust-fueled CHP plant, and shortly after the heavy oil was converted to natural gas. In 1998 the CHP plant was upgraded to a 30 MW natural gas fueled CC CHP plant with a heat storage tank, and there was established a heat transmission system (the DTU-HF transmission system) to supply DTU and Holte District heating north of DTU from the CHP plant. The heat demand connected to the DTU-HF heat transmission system is 60 GWh from DTU Campus and 100 GWh from Holte District Heating. All boilers at DTU and Holte District Heating remain as backup capacity. Thus the total installed capacity of the CHP plant, the heat storage tank and all the boilers is almost twice the maximal demand of DTU-HF on the coldest day. In 2000, DTU established a district cooling network in the tunnels to supply all cooling end-users from the three largest chiller plants.



**Figure 59. DTU Campus 2020 (Source: Strategic campus plan DTU Lyngby).**

### **6.10.2 Energy Objectives of the DTU Campus**

The objectives of the campus energy solutions are:

- To deliver cost-effective, resilient, and environmentally friendly energy for power, heating and cooling to the campus buildings
- To be prepared for the long-term development of the campus for more than doubling the building stock within the coming 30 years
- To show the three university campuses owned by DTU and managed by the DTU Campus service as a world class demonstration.

### 6.10.3 The Campus Projects at DTU in Lyngby-Taarbæk Municipality

In the period 2014 to 2019, several projects have been implemented and planned to upgrade the system and integrate it into the Greater Copenhagen District heating system (see case 1 in link above), including large buildings around DTU Campus. Moreover, DTU has prepared a long-term vision for further development of the campus energy up to 2050. The following projects have been implemented or are going to be implemented from 2014 to 2020:

- The DTU-HF heat transmission system has been connected to a heat transmission system north of the system (NORFORS), to transfer up to 12 MW efficient surplus heat from a waste-fueled CHP plant in the summer season and backup in case there is no breakdown in the NORFORS transmission system. The heat supplied from this system is primarily heat, which would otherwise be wasted or could be produced by feeding more waste into the incinerator
- DTU established an economizer to extract heat from the flue gas by reducing the temperature of the flue gas from around 120 °C to 60 °C and thereby increasing the efficiency of the boiler plants from around 88 to 98% based on lower calorific value. The economizer generates 3 MW at maximal boiler load. To avoid corrosion in the stack, three stainless steel tubes were installed in the stack
- The tariff for sale of electricity from the CHP plant to the public grid changed from a fixed three-part feed-in tariff to the Nordpool market price. Previously the CHP plant had suboptimized the production and generated a loss, which was paid for by other electricity consumers. But from that moment the plant generated only in an optimal way and operated at the electricity market for generation and regulation. Due to low electricity price, the combined production of heat was reduced from around 90% to 5% of the annual demand. The rest was supplied from the efficient gas boilers at DTU and from the surplus waste heat in the summer period
- Figure 60, derived from the project of Vestforbrænding for integrating the systems, shows how the campus area is becoming an integrated part of the district heating system around the campus

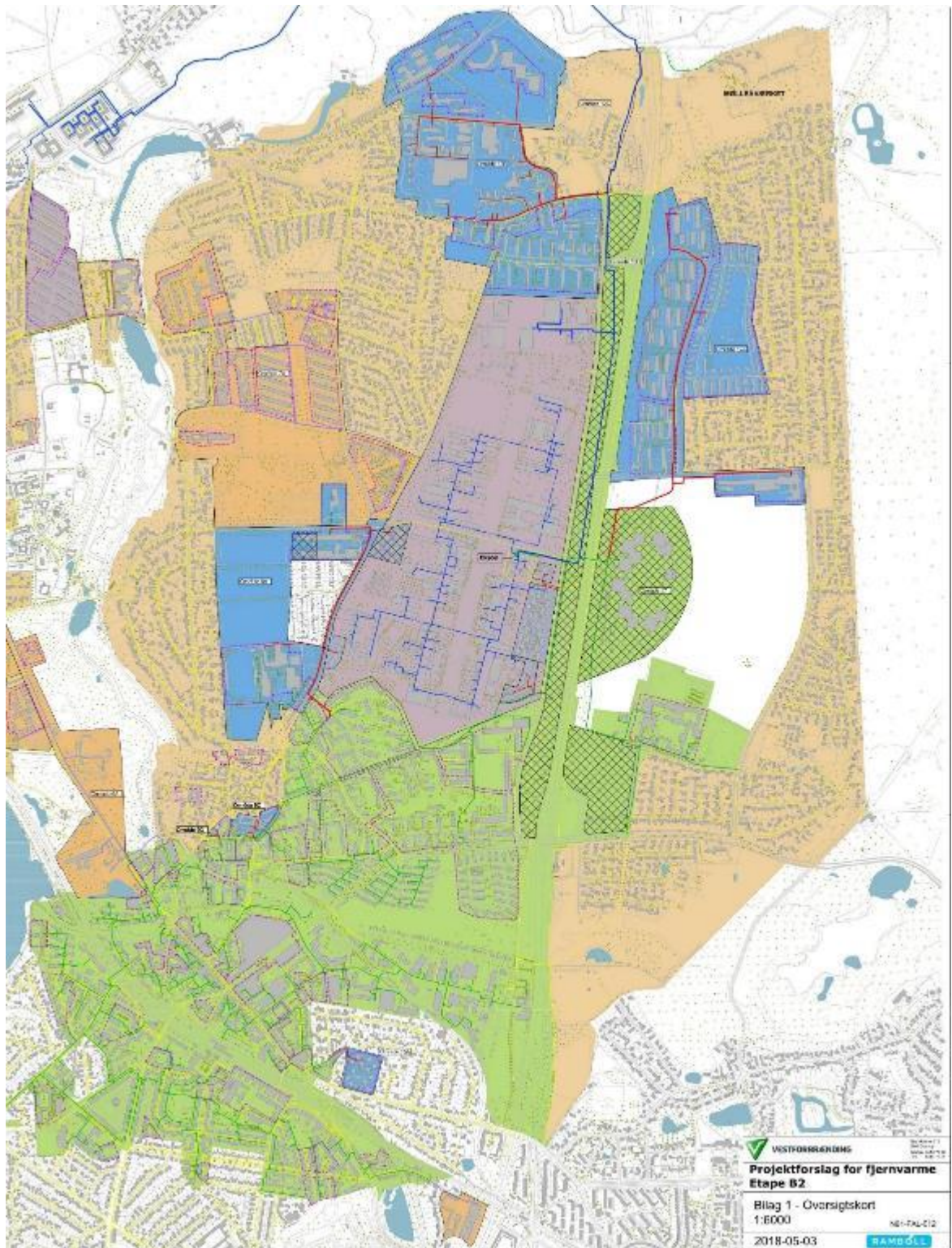

**Figure 60. Map of the district heating system around the DTU campus (Source: DTU and Ramboll).**

The connection to Vestforbrænding and thereby Greater Copenhagen District heating system is via a DN350 green pipe going south. The DTU-HF network is the blue DN250 pipe going north.

- The boilers at DTU, which previously were only connected to the Campus grid, were now connected directly to the transmission grid of DTU-HF and could feed heat into the storage tank in parallel with the CHP plant. Thereby it was more efficient for the CHP

plant operator to optimize the production of heat from CHP and boilers considering the storage volume of the tank. To increase the resilience for DTU, the old connection to the boilers remain, enabling DTU to reconnect the boilers to supply DTU only, in case the DTU-HF heat transmission system breaks down.

- The heat transmission system of Vestforbrænding, which is part of the Greater Copenhagen District system, had in the same period (from 2014) been extended to the municipality of Lyngby-Taarbæk and supplied densely populated area south of DTU. This network has now been connected to DTU-HF transmission network via a heat exchanger at the CHP plant. Interconnecting these two networks have the following benefits for DTU and the other stakeholders:
  - Vestforbrænding can supply efficient renewable heat from the Greater Copenhagen District heating system as a base load to DTU-HF. However, due to connection of many consumers and limited transmission capacity, this capacity is fully used in the coldest 5-6 months, and the gas boilers at DTU have to operate for peak generation.
  - The surplus capacity in DTU-HF, including part of the capacity of the boiler plants of DTU, can be transferred to Vestforbrænding, which can therefore supply the urban area south of DTU without investing in any new peak capacity.
  - The total operation and production of heat from the CHP plant at DTU, the heat from NORFORS and the heat from the Greater Copenhagen District heating system can be optimized.
- A 40 MW electric boiler is in 2019 at the CHP plant using the available cable to the CHP plant, which normally is used to transfer power to the grid.
- DTU can, in the operation of the district cooling system, analyze the most likely need for new cooling capacity and recognize that the maximal capacity demand is only around 47% of the total installed capacity of around 80 cooling devices at DTU, which is mainly for process cooling (not for comfort cooling in the old buildings). However, due to increasing building stock and need for comfort cooling to all new buildings, DTU needs to install new cooling capacity. As an alternative to traditional chillers and to supplement the existing chillers, DTU plans to install a heat pump with a capacity of 2.4 MW cooling and 3.4 MW heat. As there is available space in the 6-year-old boiler house, it is the plan to establish the heat pump as two units in the boiler house right next to the heat exchanger between DTU and DTU-HF and the boilers of DTU. The heat pump will be connected to the local network for normal operation, but also to the DTU-HF transmission network, to ensure that all the heat capacity can be used in the warmer periods in which the heat load in the campus network is lower than 3.4 MW. The heat pump will be able to generate around 5 GWh cold and 7.5 GWh heat annually in combined production with cooling, corresponding to 2.000 hours of max. load, thus only 25% of its production capability is used.
- As the heat pump has available capacity and replaces gas boilers in half of the year the plan is to deliver cooling to the flue gas via a flue gas condensation unit. This condensation unit will be installed right after the economizer will be able to cool the flue gas further from 60 °C to 25 °C and thus achieve maximal condensation of the wet flue gas. It is expected that additional 3 MW can be extracted from the flue gas, and that the Coefficient of Performance (CoP) factor for this will be around 5. Thus, the total efficiency of the gas boilers will be around 110% based on the lower calorific value
- The generation of heat from the DTU heat pump at the campus will indirectly increase the performance of the heat supply to DTU-HF and Vestforbrænding in the district around the campus. Moreover, Vestforbrænding plans to install a similar heat pump to generate combined heating and cooling to new buildings outside the campus area and to use surplus heat from a sludge incinerator at a wastewater treatment plant north of the campus and also a heat pump to extract heat from the wastewater, which will contribute to a more efficient heat generation in the area around DTU. That will stimulate a further

extension of the district heating based on efficient base load generation and available surplus capacity

- The production of the CHP plant, the boilers and the heat storage tank is already today optimized on a weekly, daily, and hourly basis by the operator using the optimization tool Mentor Planner, based on electricity price and weather forecast. In the future, this optimization tool will be even more important as it has to integrate the interaction with the electric boiler and the heat pumps as well as the price signals from the Greater Copenhagen District heating system
- Both the CHP plant and the electric boiler exchange power with the regional power high voltage grid, and DTU has its own power distribution grid to the campus connected to the same grid. In principle, the CHP plant and the electric boiler and the micro grid of DTU could be disintegrated from the regional power grid and operate as an independent microgrid and even in island operation. That would however not be optimal from an overall perspective and could never be justified with reference to resiliency, as the regional power grid is very reliable and as the CHP plant serve as backup for both the regional grid and DTU's own grid. Nevertheless, as DTU owns its own distribution grid, DTU is able to operate heat pumps in an optimal way considering that the heat pumps can interrupt heat generation in case of capacity problems in the grid
- Figure 61 shows the tunnel system, with old heating pipes at the upper right and new cooling pipes at the lower right part of the picture.



**Figure 61. Heating and cooling in the tunnel system (Source: Ramboll).**

Figure 62 shows a map of DTU today with tunnel and DC installations marked.



**Figure 62. DTU in 2019 with tunnel and DC installations (Source: DTU).**

Figure 63 shows a diagram of the energy infrastructure in the tunnel system in the long-term solution in the Campus Strategy Plan, including the heat pumps for combined heating and cooling as will be established at the boiler plant (T) and integrated in the some of the Parking buildings (P), and one of them will host a chilled-water tank. Table 21 lists additional Information on DTU case.

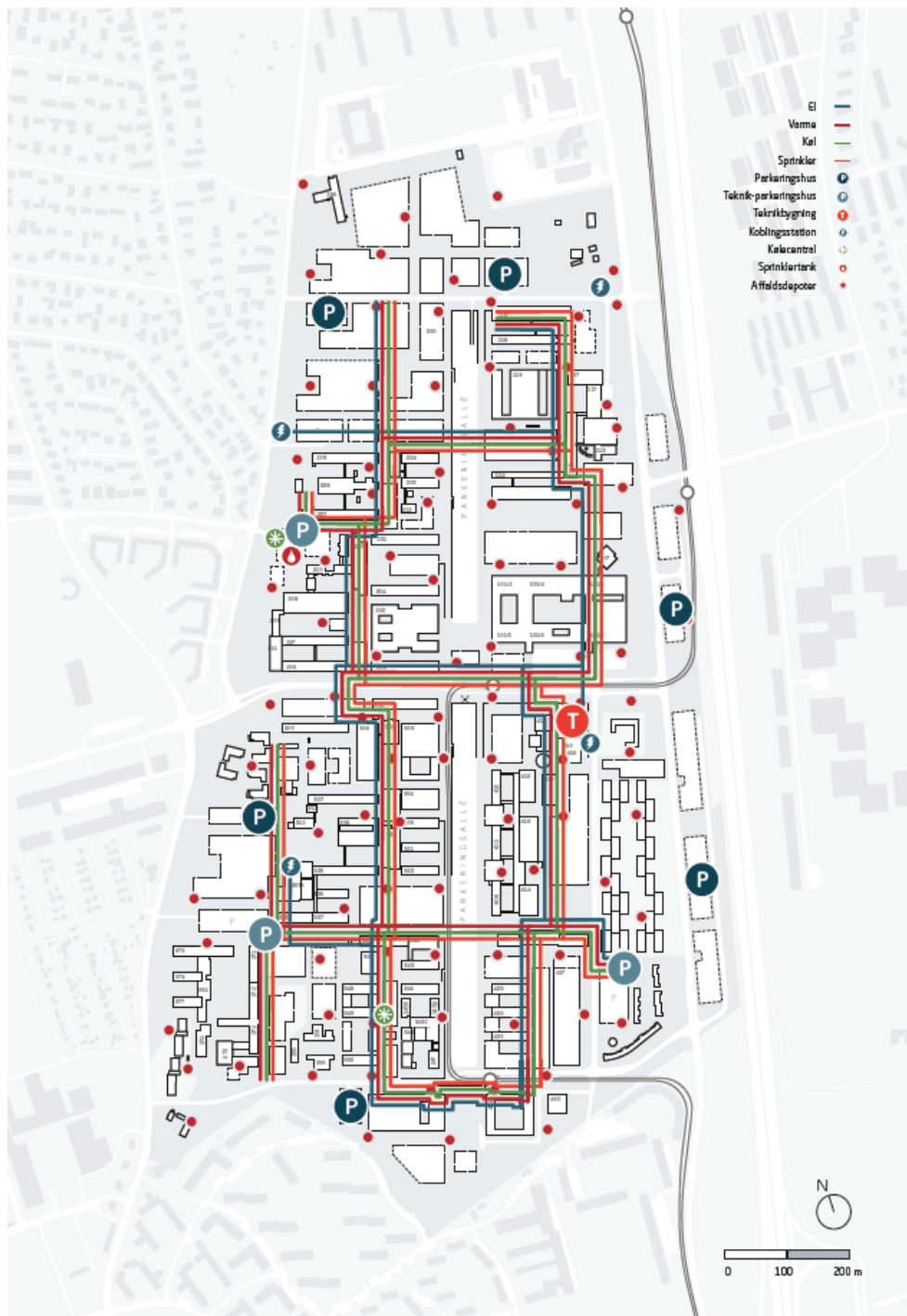
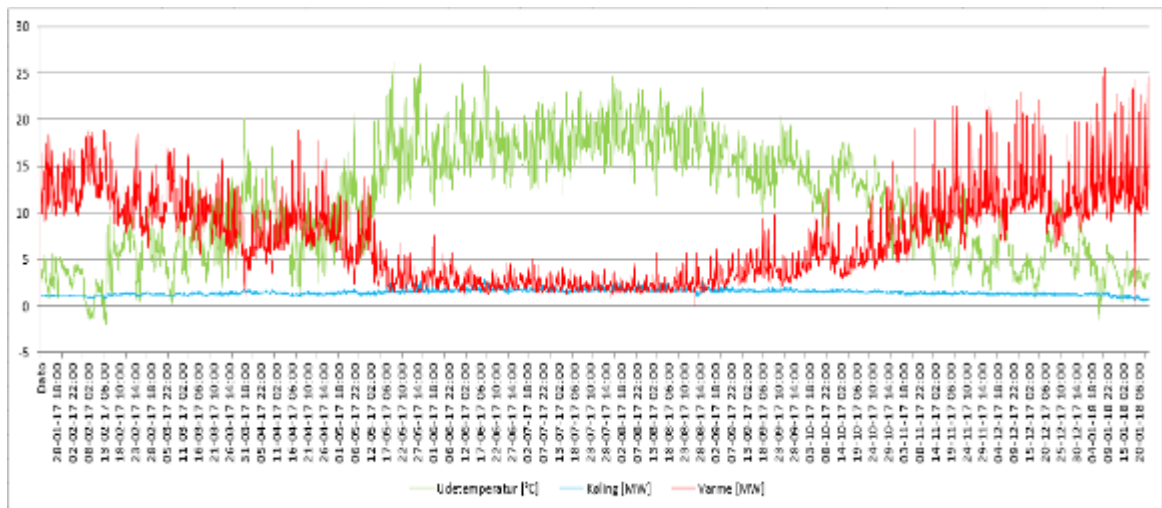

Figure 63. Long-term development including new buildings and infrastructure in the tunnel system. The infrastructure. electricity (green), district heating (red), district cooling (blue) and water for fire protection (orange). (Source: Strategic campus plan DTU Lyngby.)



**Table 21. Additional Information on DTU case.**

Building mix in the area:	400,000 m <sup>2</sup> , planned to be 1,200,000 m <sup>2</sup> in 2050 Office buildings and laboratories
Consumer mix in the area:	Large consumers
Energy plant owner (public or private):	Public campus owner, but private owner of CHP
<ul style="list-style-type: none"> <li>• Heat supply network in tunnels</li> <li>• 60 GWh Heat demand, planned to be 95 GWh in the long term due to efficient new buildings</li> <li>• DTU is part of the DH system DTU-HF which has a total demand of 160 GWh</li> <li>• 2.500 max load hours measured and estimated based on actual consumption and weather data</li> <li>• 25 MW maximal design capacity to the network at DTU</li> <li>• 30 MW capacity from 3 gas fueled boilers to DTU-HF or to DTU local network</li> <li>• 3 MW capacity from flue gas economizer to DTU-HF</li> <li>• 38 MW electric capacity from gas CC CHP plant</li> <li>• 33 MW heat capacity from gas CC CHP plant to DTU-HF</li> <li>• 8,000 m<sup>3</sup> pressure less heat storage tank to DTU-HF</li> <li>• 30 MW heat exchanger from DTU-HF transmission to DTU local network</li> <li>• 12 MW from transmission from NORFORS to DTU-HF</li> <li>• 30 MW heat exchanger for exchange +/- between DTU-HF and Vestforbrænding</li> <li>• 40 MW electric boiler under construction to DTU-HF transmission system</li> <li>• Normal supply temperature 70-80 °C</li> <li>• Normal return temperature 50-55 °C</li> <li>• district cooling network in tunnels</li> <li>• 3 MW district cooling maximal capacity</li> <li>• 6 GWh cooling for process, estimated to 60 GWh in the long-term incl. new comfort cooling</li> <li>• 3 MW existing old chillers</li> <li>• 2.4 MW cold / 3.4 MW heat pump in the planning stage connected to flue gas condensation</li> <li>• Power grid in tunnels</li> </ul>	



**Figure 64. Profiles for outdoor temperature (green), heat load (red), cooling load (blue).**

### 6.10.4 Technical Highlight

The 8,000 m<sup>3</sup> pressure-less heat storage tank next to the CHP plant (Figure 65) and the old boiler plant (tall stack to the right) are important for the optimization of the heat and power generation.



## 6.10.5 Decision and Design Process

### 6.10.5.1 General/Organizational Issues

The project was initiated for several reasons:

- DTU campus was established as one big project and this was the opportunity to establish a district heating system in a combined tunnel infrastructure and heated by one single boiler plant
- This grid has been an opportunity to adopt the changes in the energy policy, first replacing oil with gas, then use the gas more efficient with a CHP plant and finally to start integrating fluctuating electricity in the energy system

Who were the major stakeholders?

- *DTU as a state organization*
- *The Municipality of Lyngby-Taarbæk*
- *The gas distribution company, who established gas supply to boilers and CHP plant*
- *The Power company, who established the CHP plant at the campus area*
- *The electricity distribution company NESAs, who invested in the transmission line from the CHP plant to DTU and Holte District heating*
- *The consumer-owned district heating company Holte Fjernvarme, with whom DTU formed the district heating company DTU-HF and bought the heat transmission network from NESAs*
- *The company DCG, who bought the CHP plant from the power company and continued all contractual relations*
- *The district heating company NORFORS, who delivers 12 MW surplus heat to DTU-HF*
- *The district heating company Vestforbrænding who:*
  - *Established a DN350 district heating pipe connection to DTU-HF to exchange heat between the companies*
  - *Rented surplus heat production capacity from DTU and the other stakeholders*
  - *Supplies a few other consumers at the campus area*
  - *Is going to establish the 40 MW electric boiler in cooperation with DCG.*

Which stakeholders were involved in the project?

*All the stakeholders listed above had their role.*

Which resources were available before the project? What are local energy potentials?

*There we no local resources*

*The energy potential is that the campus and several city districts around the campus have a large building density and that there is an ongoing urban development.*

Who (what) were drivers and who (what) were opponents (barriers) – and why?

*The main driver was that the government wanted to reduce the dependency of oil*

### 6.10.5.2 The Campus Objectives

What have been the main challenges regarding decision finding?

*Vestforbrænding elaborated a project proposal in accordance with the Heat Supply Act for interconnection and for extension of the DH system to replace gas boilers. This was divided in two subprojects, one for interconnection and new buildings and one for shift from gas to DH. The first and most important was approved by the city council in accordance with the Heat*

*Supply Act according to the plan, whereas the other was delayed due to negotiations and disputes with the gas company.*

*Having the formal approval from the municipal planning authority, the main challenge was to agree among all stakeholders, in particular as one of them was a private investor who owed the CHP plant, in particular the project for supply of heat from Vestforbrænding and negotiating contracts with DTU-HF, DTU and DCG, which is privately owned.*

*With regard to the heat pump, DTU has submitted a project proposal in accordance with the Heat Supply Act, but is still awaiting approval from the municipality and the Energy Agency, which has to administer the Secondary Act, which has not yet been fully adjusted to the new energy policy.*

What was finally the crucial parameter for go /no-go decision?

*Approval from the planning authority and agreements among parties.*

### **6.10.5.3 Financing Issues**

DTU has via the planning been able to establish energy supply cheaper than else.

Vestforbrænding had been able to finance all their investments based on lowest interest rate, due to the fact that the consumers pay, that the project is profitable for Vestforbrænding and that the municipalities who own Vestforbrænding guarantee for the loan.

Which business model applies to the project?

- *DTU Campus service is an energy consumer who owns almost all buildings at the campus area, which provide services for electricity and thermal comfort based on building level investments and supply of heating and cooling.*
- *DTU-HF is owned by DTU and Holte District heating company and therefore, all gained profit is given to the owners and in terms of reduced heat prices.*
- *Holte District Heating company is owned by the heat consumers, and therefore all this profit is being used to reduce the heat prices.*
- *DCG is a private company, who within the regulation in the Heat Supply Act can make profit/loss of operation of the CHP plant in the market.*
- *Vestforbrænding is owned by municipalities and all profit is include in the price forecast to lower the heat price to all heat consumers.*

### **6.10.5.4 Technical Issues**

What have been major technical challenges/constraints regarding system design?

- *There have been no major challenges.*
- *It has been discussed how to interconnect the two transmission systems, directly or indirectly via heat exchanger. The first solution would be preferred, but it was only possible to agree on the second in the first stage due to different pressure levels.*
- *With regard to the heat pump, the maximal heat capacity that shall be fed into the local heating network may exceed the maximal demand. Several solutions can solve the problem, but the most likely is to establish an additional minor heat exchanger for transfer of heat to the transmission network.*

What solutions have been considered for generation, storage and load management?

*In addition to the thermal storage, a chilled-water storage is considered in the next stage, since the best site for it has been identified.*

*The load management for optimizing the total operation for heat in the integrated system is a task for either Vestforbrænding or the owner of the CHP plant, whereas DTU will operate the cooling and the heat pump considering the cooling load, the electricity price and the heat price.*

### **6.10.5.5 Design Approach Applied**

Which design targets have been set and why?

*The installations have been designed based on measurements of capacity demand and performance of the existing infrastructure.*

### **6.10.6 Resilience**

The backup boiler can offer maximal backup capacity in case the heat transmission system breaks down, as it can shift to the campus network. The burners operate on gas, but could in case of unreliable gas be converted to combi burners, which can shift to oil.

The cooling grid is supplied from several chillers and a heat pump will be installed. Moreover, the network is a ring network and all consumers on the network can be supplied from one side or the other.

The electricity micro grid at DTU owned by DTU has sufficient security of supply from the public grid, as the public grid is very reliable; however, in principle, the network could be supplied from the CHP plant at the campus area and operate in island mode.

DTU has installed a SCADA system for monitoring and control of the supply system, including heating, cooling, and electricity consumption and supply.

All energy infrastructure is established in the tunnel system and well protected against damage and impact of the climate, and the tunnel system is monitored for possible leakage and penetration of water.



The operation of the production in particular the CHP plant and the electric boiler (under construction) is guided by the optimization system Mentor Planner, which offers the operator an overview and a guidance of the operation.

Therefore, the system serves as a good model for campuses for which resilience could be a crucial parameter.

### **6.10.7 Lessons Learned**

The project is a good model for a campus, which can establish its own resilient heating, cooling and power supply; it also has a high sustainability score, as the projects are cost effective for the society (including environmental costs) and they contribute to more cost-effective energy for the local community. It also proves that it is possible to cooperate with other stakeholders in the neighborhood.

## 6.11 District Quaanaap in Greenland, Denmark

Case No.	Country	Location	Specific Type	Photo	Special points of attention
11	Denmark, Greenland	Quaanaap	District District heating in a small town		 district heating
<p><b>Country:</b> Denmark, Greenland</p> <p><b>Name of city/municipality/public community:</b> Quaanaaq</p> <p><b>Title of case study:</b> Arctic district heating</p> <p><b>Author name(s):</b> Anders Dyrelund/Henrik Steffensen</p> <p><b>Author email(s):</b> ad@ramboll.com/hst@ramboll.com</p> <p><b>Link(s) to further project related information/publications, etc.:</b>  <a href="https://stateofgreen.com/en/partners/ramboll/solutions/low-carbon-arctic-community-qaanaaq-in-greenland/">https://stateofgreen.com/en/partners/ramboll/solutions/low-carbon-arctic-community-qaanaaq-in-greenland/</a>  <a href="http://stateofgreen.com/files/download/540">http://stateofgreen.com/files/download/540</a></p>					

### 6.11.1 Background and Framework

In remote arctic regions far from the electric grid, the challenge of resilient solutions and efficient use of resources and opportunities is obvious.

When practically no local resources are near, the aim is to cost-effectively minimize the import of Arctic Grade Oil for the diesel motor powered generator and for the heating of buildings. If some local resources could be viable, it is a challenge how to use them.

The establishment of Qaanaaq close to the north pole took place back in 1952-53 to host the native population of the Uummanaq area (Figure 67), which in 1951 became the Thule Air Base.



**Figure 67. The new urban settlement Quaanaaq in Greenland (Source: Nukissiorfiit).**

As the settlement was planned as a green-field project, it was possible to establish an infrastructure that was both energy efficient for its time and resilient for the population.

As a result and after some modifications up through the 1990s, the system in Qaanaaq can show remarkable high energy efficiency today, which should be a landmark for any other local and isolated community.

The district heating infrastructure that is the key to this high efficiency is owned by Nukissiorfiit, Greenland's national supply company, and Ramboll has provided the consultancy services.

The overall efficiency of the imported arctic fuel (light oil) for electricity and the heating measured at end-user level was, up to year 2010, around **80-85%** based on the LCV (lower calorific value), as a fully developed district heating network distributes all the surplus heat from the diesel engines. In fact, this surplus energy, which would otherwise be wasted, covered around 70% of the total heat production. If there had been individual oil boilers instead of district heating, the total efficiency of all electricity and heating would not have been 80-85%, but only **55%** (40% for the electricity only and 80% for small oil boilers). Figure 68 shows the energy balance for Qaanaaq

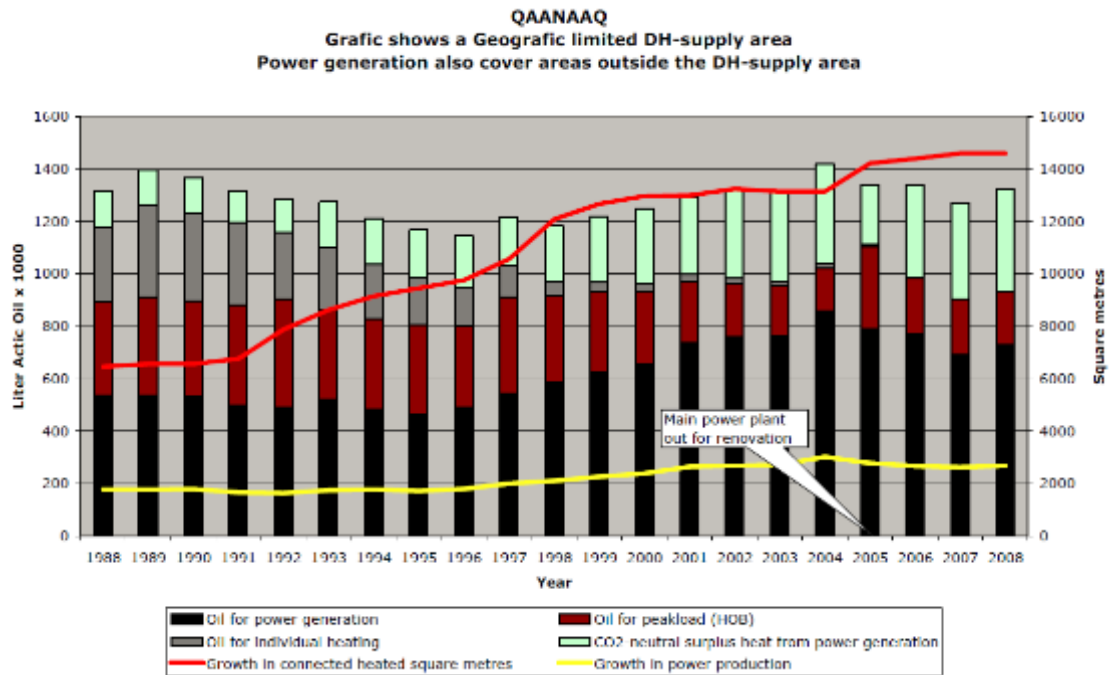

**Figure 68. Energy balance for Qaanaaq (Source: Nukissiorfiit).**

It is remarkable that an overall efficiency of 80-85% is possible without a thermal storage, which could be installed if necessary. Moreover, if the network is supplemented by a thermal storage, it will be ready for efficient integration of renewable energy like wind and solar PV. These renewables would supplement the diesel engines and boiler and renewable energy would be absorbed by an electric boiler, stored in a tank, and used for heating in accordance with the demand.

Additionally, the district heating system opens for use of local waste, which is the case in several larger settlements in the Arctic. In the short term, hydropower alone, and in mid- and longer-term, hydrogen and carbon captured synthetic generated E-fuels using the significant potentials for the entire country would be an option.

**An important precondition for these future success is that the heating density is sufficient and that the costs of the district heating pipes are modest, as they are placed in ducts above ground together with other infrastructure, such as wastewater pipes and fresh water pipes, which is protected against frost — a symbiosis as the low heat losses of the district heating pipes is contributing to keep the other pipes warm. Moreover, all the heat losses are generated by heat**

from the diesel engines, which would otherwise be ejected to the ambient air (see Figure 69).



Figure 69. Cooling fans on the roof are now used only for emergency (Source: Nukissiorfiit).

Table 22 lists additional information on district Quanaap (mostly measured in 2010).



Figure 69. Cooling fans on the roof are now used only for emergency (Source: Nukissiorfiit).



**Table 22. Additional Information on district Quaanaap (mostly measured in 2010).**

Inhabitants	656 people in 2018
District heating Heated floor area	14,600 sqm
Annual heat demand (DH) an net	5,227 MWh
Annual electricity demand	2,752 MWh
Combined heat and power plant:	2 newly (2015) renovated B&W-man MBDH diesel engines type 5T23LH from 1984, 550 rpm. Rating each 518 kW power, plus 1 Scania diesel engine type DI 16 44, 1500 rpm rating 400 kW power. All units are cooled by DH return water, from turbocharger, lubrication, piston, and cylinders to the exhaust gas systems that are attached to exhaust boilers for optimal use of energy almost to condensation level. Additionally, 2 Scania diesel engines each with generators rating 600 kW power serving as emergency units.
CHP Power/heat capacities:	Total generator capacity 1436 kW power. Steady performance 918 kW power. Surplus heat from 3 temperature levels ranges 2.5 MW thermal.
Boiler Heat capacity:	Three Peak load boilers Danstoker type VBN can operate in parallel and in series with the CHP plant. The Peak load boiler plant was renovated in 2000-2004. New boiler capacity 1.51 MW thermal. Efficiency rate 93-95% at fluegas temperature of 110-120°C.
Total efficiency of power and heat generation	90%
Total efficiency of the DH-network	85%
Total efficiency of the Power grid	95%
Total efficiency of heat and electricity at end-user level	80-95% (end-use measured / fuel)

Figure 70 shows the infrastructure, which interconnect the buildings in this arctic climate. Note that all the infrastructure is above ground as it is very difficult to keep it under ground in the arctic climate with permafrost.



**Figure 70.** The infrastructure in Quanaap, Greenland, is above ground due to permafrost (Source: Nukissiorfiit).

## 6.11.2 Decision and Design Process

### 6.11.2.1 General/Organizational Issues

Why was the project initiated?

*The population from Uummannaq/Thule area needed a new settlement. The town Quanaaq was established as a green-field project, like it was a campus.*

Which resources were available before the project? What are local energy potentials?

*There were sufficient financing to establish the infrastructure, and it could be planned in the most cost-effective way*

*There were no local energy potential at all.*

Who (what) were drivers and who (what) were opponents (barriers) – and why?

*The drivers was fast and simple to establish an energy-efficient urban infrastructure suitable for the arctic climate and soil*

What have been the main challenges regarding decision finding?

*All options were open because the settlement was forced to move.*

What was finally the crucial parameter for go /no-go decision?

*The hunting grounds were under severe pressure from the newly created air base.*

### **6.11.2.2 Financing Issues**

Construction of the new settlement in 1952 was financed by the Danish state budget. The modernization up through the 1990s was financed by Greenland's home rule.

Which business model applies to the project?

*The public utility of Greenland is responsible for all the infrastructure and the cost of heat as well as electricity are average prices.*

### **6.11.2.3 Technical Issues**

What have been major technical challenges/constraints regarding system design?

*In recent years, it has been a challenge to operate and maintain the installations as well as keeping a steady qualified staff as it is a remote settlement. Therefore, it has not been possible to collect all data and maintain the large efficiency continuously.*

What solutions have been considered for generation, storage and load management?

*Obviously, the maximal use the surplus heat has been possible without storage tank, as there is a good match between thermal power generation and heat demand.*

### **6.11.2.4 Design Approach Applied**

Which design targets have been set and why?

*Targets have been cost effectiveness and resilience as it is a remote settlement in the arctic, and therefore district heating in ducts with other infrastructure based on efficient use of surplus heat has been an obvious solution.*



### **6.11.3 Resilience**

The hot water district heating in ducts and a diesel generator divided on several engines offers the most resilient energy and environmental services in the arctic climate.

### **6.11.4 Lessons Learned**

The project demonstrates that it is possible to plan and operate an efficient and resilient energy services in symbiosis with water and wastewater in the arctic, however it also shows that it is difficult to keep and attract qualified staff to ensure efficient operation and a high maintenance standard.

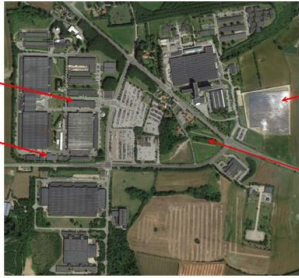
## 6.12 Company Campus of Danfoss, Denmark

Case No.	Country	Location	Specific Type	Photo	Special points of attention
12	Denmark	Danfoss Campus	Campus Company Campus		 <p>district heating, heat pump, solar energy, thermal storage</p>
<b>Country:</b>		Denmark			
<b>Name of city/municipality/public community:</b>		Nordborg			
<b>Title of case study:</b>		Danfoss campus energy renovation			
<b>Author name(s):</b>		Oddgeir Gudmundsson			
<b>Author email(s):</b>		<a href="mailto:og@danfoss.com">og@danfoss.com</a>			

### 6.12.1 Background and Framework

Danfoss Nordborg energy renovation involved a smart energy renovation of an industry campus. In 2007 it was decided to investigate and implement energy-saving measures in Danfoss campuses around the world. This case study discusses the energy renovation process in the Nordborg campus.

The Danfoss campus in Nordborg (Figures 71 and 72) is the initial production campus of Danfoss. The buildings were built in the 1950s to 2000. The buildings are a mix of production facilities and office buildings, in total there are 27 buildings with total of 250.000 m<sup>2</sup> floor area. Over the years, the facilities have been changed to fit the evolving production processes as well as generally changing usage of the buildings. The campus has its own natural gas CHP plant that has been used for generating power and heat for the campus area. Additionally the campus is connected to the national power grid for operational security and resilience reasons.

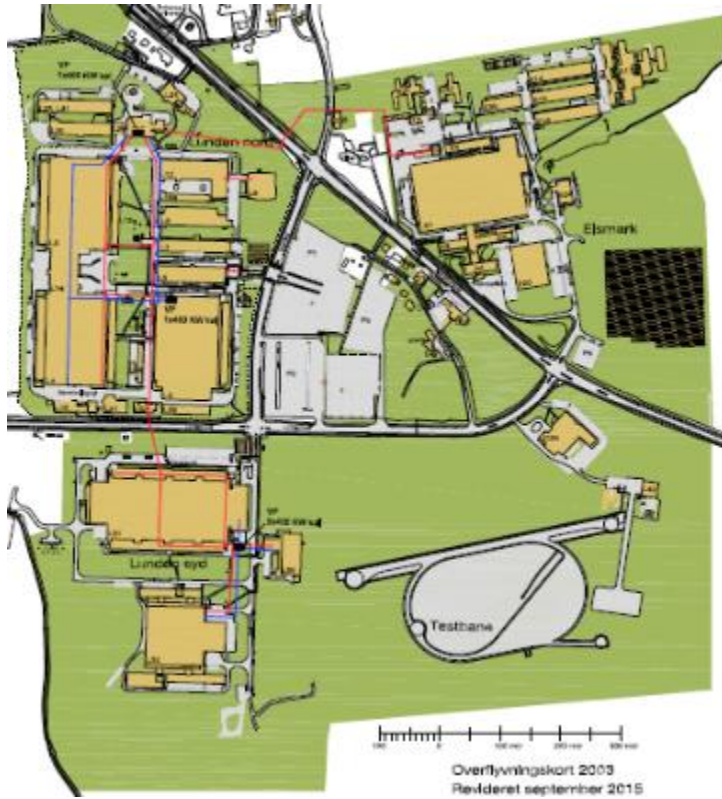

Figure 71. Danfoss Nordborg Campus (Source: Danfoss).

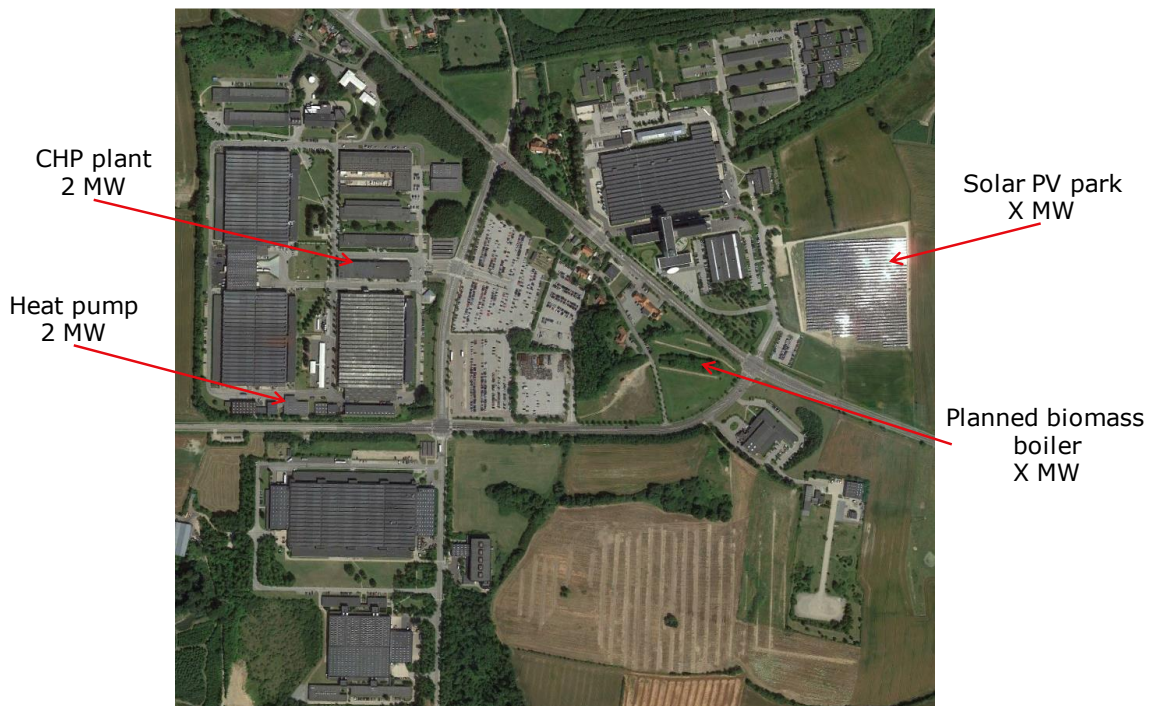

Figure 72. Areal view of the campus area (Source: Danfoss).

### 6.12.1.1 Energy Market and the Campus Energy Supply

The campus has its own natural gas CHP plant that has been used for generating power and heat for the campus area. The campus also has its own microgrid district heating system. Additionally, the campus is connected to the national power grid for operational security and resilience reasons. In 2016 the national power grid fuel mix was 37.2% was fossil fuel based,

2.3% from nonrenewable sources and 60.5% from renewable energy sources. Beginning in 2020, the municipality plans to install a district heating system connecting the towns Nordborg, Guderup, and Ketting. As the Danfoss Nordborg campus is situated in the middle of the planned network, it will host the biomass heat plant that will supply the district heating in the campus area and become an anchor load customer.

### 6.12.1.2 Campus Energy Supply

Before the energy renovation work, the campus had two distribution networks, a high temperature network, supply 152 °C and return 137 °C, supplying buildings that required process heat, space heating and domestic hot water preparation, and a separate lower temperature network, supply 92 °C and return 85 °C, to buildings that only had space heating and domestic hot water preparation requirements. The high temperature requirements made the system both inefficient and not capable for use of waste heat from local manufacturing processes. In 2007, the reference year, the heat demand of the campus was 83,550 MWh, fully supplied by a natural gas boiler (Figure 73). In 2017 the heating degree day normalized heat demand was 29,900 MWh, where 67% was based on natural gas and 33% from waste heat that had been temperature enhanced by a heat pump. In addition to the thermal energy savings, efficiency improvements on the electric side has led to almost 45% electricity savings. Tables 23 and 24 list and Figure 74 shows additional quantitative information on energy supply of Danfoss Campus.

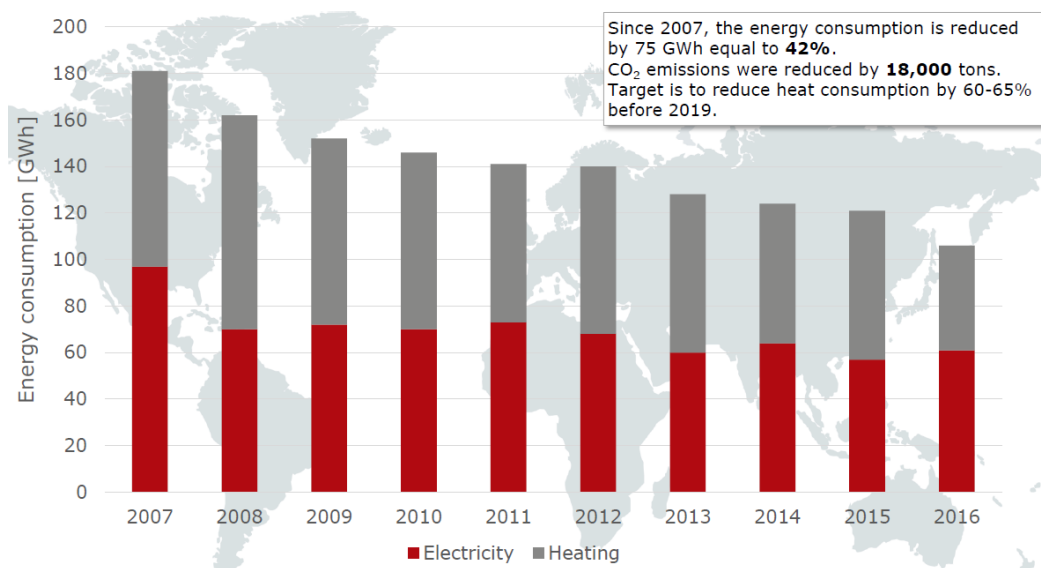

**Figure 73. Electricity and heating demand of Danfoss Campus has significantly decreased between 2007 and 2016 (Source: Danfoss).**

Table 23. General quantitative Information on energy supply of Danfoss Campus.

	Urban scale of area [m <sup>2</sup> ]	Total gross floor area [m <sup>2</sup> ]	Heated floor area [m <sup>2</sup> ]	Population/Users in the area	Thermal energy demand [GWh/a] (in 2017)	Network heat losses [%]	Heating grid trench length [m]	Number of consumer substations; heat	Number of producer substations; heat	Supply/return T [°C]	Thermal energy storage volume [m <sup>3</sup> ]	Annual heat yield from local renewable <sup>1</sup> sources [MWh] (*waste heat)	Cooling energy demand [MWh/a]	Electrical energy demand [MWh/a] (in 2016)	Annual electric energy yield [MWh/a]
Before		250,000	250,000		84.1			27	1	152/137 92/85	1.000	0	-	96.7	82,000
After		250,000	250,000		30.0			27	2	77/40	1.000	10,000	-	60.6	45,000

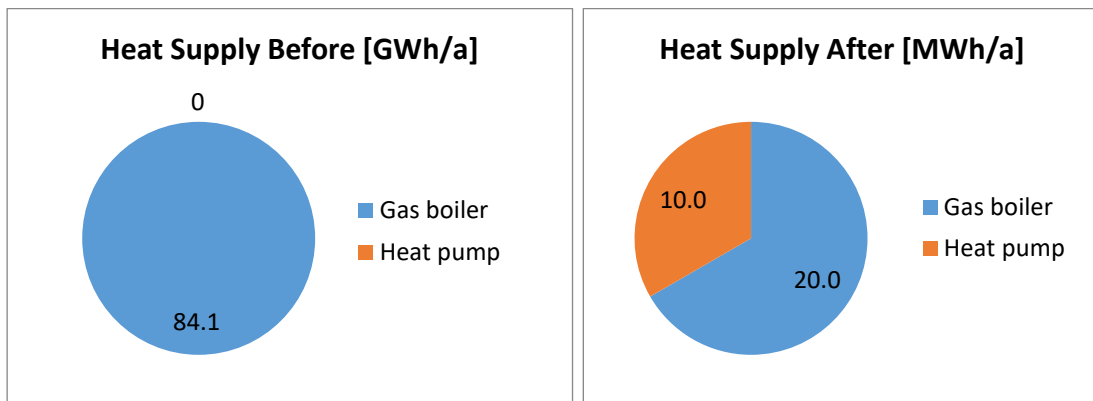

Figure 74. Heat supply of Danfoss Campus before and after renovation.

**Table 24. Additional Information on Energy Supply of Danfoss Campus.**

<b>Additional Information:</b>	
<b>Building mix in the area*:</b>	160,000 m <sup>2</sup> factory facilities and 90,000 m <sup>2</sup> office facilities
<b>Consumer mix in the area**:</b>	One consumer – Danfoss
<b>Energy plant owner (public or private):</b>	Private
<b>Insert additional information that is relevant for this project. The list below is only an example</b>	
<b>Thermal energy supply technologies***:</b>	Natural gas CHP, oil boilers and heat pumps
<b>Thermal energy production from solar:</b>	No
<b>Geothermal collectors:</b>	No
<b>Thermal energy storage:</b>	1.000 m <sup>3</sup>
<b>Investment costs****:</b>	21,540,000 [EUR], 75% own funding, 25% subsidies
<b>Cooling energy used:</b>	Adiabatic cooling using ground water
<b>Available cooling power:</b>	N/A
<b>Electrical energy demand:</b>	Before renovation: 82,000 [MWh/a]
<b>After renovation:</b>	45,000 [MWh/a] (measurement)
<b>Voltage level:</b>	The campus is connected to the 15 kV grid and has transformers on-site to adjust the voltage to the desired voltage
<b>Peak power demand:</b>	15 MW
<b>Electric power supply technologies:</b>	Grid connection and solar PV with 2 MW capacity
<b>Annual electric energy yield:</b>	
<b>Backup power, critical demand:</b>	4 MW gas fired CHP

### 6.12.2 Energy Objectives

Before the initiation of the energy efficiency renovation project, the general consensus was that the campus was running efficiently. The project was part of a local initiative, Project Zero, which is aiming for zero CO<sub>2</sub> emissions for the local community as well as to prepare for connecting the campus to the district heating system that will be built in the area. The first part of the analysis was to increase the energy consumption measurement points to allow for tracking where the energy was being used. After a detailed analysis based on the measured data had been performed on all aspects of the energy consumption, it was realized that the heating energy consumption could be more than halved and the electricity consumption could be reduced by up to 40% using well-known and proven technologies.

The energy objectives were to:

- Save energy on ventilation and air-conditioning
- Increase process energy efficiency and capture/reuse waste heat
- Upgrade the heating installations, insulate buildings and run with low supply temperature heating
- Renovate the campus heating system to facilitate future connections to the planned district heating system
- Install light emitting diode (LED) lights and implement light control system.

The overall objective was to achieve 34% savings in energy consumption through cost sustainable energy efficiency measures. The following sections describe the main measures.



## 6.12.3 Technical Highlights and Efficiency Measures

### 6.12.3.1 Ventilation

Installation of a large industrial ventilation systems with heat recovery by connecting exhaust heat from production processes into the main ventilation system realized energy savings that vary from area to area, but that are between 30% to 75% (Figure 75).



**Figure 75. Left: large ventilation system installed in the production halls to collect exhaust heat from machinery; right: main ventilation system (Source: Danfoss).**

### 6.12.3.2 Process Heat

Before the energy efficiency projects, the process cooling water was cooled by use of cooling towers, resulting in ~10.000 MWh of heat vented to the atmosphere every year. To recover this heat from the process cooling water, four 500 kW ammonium-based industrial heat pumps were installed (Figure 76). The heat pumps are optimized with a Turbocor® compressor. The heat pumps are cooling ~250-350 m<sup>3</sup> per hour from 26-30 °C down to ~21 °C. Energy consumption of the pumps driving the process water was further reduced by optimizing the flow with Danfoss VLT® AQUA Drives.



**Figure 76. One of the installed 500 kW heat pumps (Source: Danfoss).**

### 6.12.3.3 Heating System Energy-Saving Measures

By taking a system optimization approach to energy efficiency, a diversity of improvements and retrofits have been implemented in the central heating system over the years. The improvements included separating the process demand from the space and domestic hot water heating demand, new central control of space heating in production halls (no individual settings), new thermostatic control valves on radiators in office buildings, increased insulation

of critical buildings, increased energy awareness of users by awareness raising and systematically monitoring for uncontrolled air exchanges, i.e., opened doors and windows.

The result was that the operating temperature for building heating could be reduced; supply temperature fell from 92 °C to 77 °C and return temperature fell to below 37 °C. The reduced temperature requirements opened up for the possibility to harness industry waste heat in the campus, 26 °C to 30 °C, and boost it via heat pumps. The heat pump is currently supplying 33% of the campus heat demand. The reduced supply temperature further increases the efficiency of the campus CHP plant, which is now used as peak and backup boiler.

Once the heat saving potential in the Danfoss campus was identified in 2007, the originally proposed business model for the district heating system became unsustainable and needed to be reconsidered. After reconsidering the district heating business model to consider the significantly reduced heat demand from Danfoss, the decision was made to construct the network. Once the district heating system becomes operational, planned for 2021, it will replace the current natural gas-based heat supply in the campus with green heat from a biomass boiler.

#### **6.12.3.4 Rationales for the Energy Savings Projects**

The key motivator for the energy savings has been to take responsibility of own energy consumption and to provide an economically sustainable showcase on energy efficiency improvements for the industry using well proven technologies. Additional rationales have been to reduce emissions from energy consumption to comply with national requirements, fulfill local government targets, free resources, increased resilience, and competitiveness.

#### **6.12.3.5 Key Points**

- Ensure that energy consumption measurements are performed at relevant locations
- Identify the energy-saving potential before considering changing of the heat supply.
- Energy efficiency makes a great business case for industry and business, but regulatory push is needed.
- The solutions identified in the Nordborg campus (Figure 77) are easily transferable between industries.

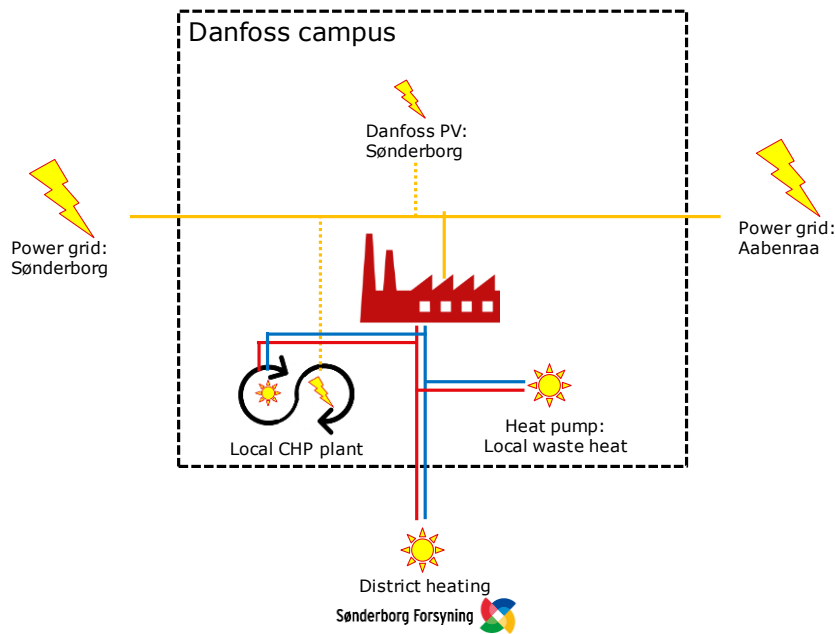

**Figure 77. Energy system in the Danfoss Nordborg campus (Source: Danfoss and Sønderborg Forsyning).**

## 6.12.4 Decision and Design Process

### 6.12.4.1 General/Organizational Issues

Why was this project initiated, to answer which need?

*In accordance with Danish national and local governmental climate goals as well as the ambition of Danfoss to lead the way in energy efficiency, it was decided to explore energy-saving opportunities within Danfoss premises around the world. For Danfoss Nordborg campus, there was also a need to prepare the campus for connecting to the district heating system planned to be constructed in the area.*

Which stakeholders were involved in the project?

- *Danfoss property management department*
- *Different business segments*
- *Manufacturing process owners*
- *COWI consultants*
- *Sønderborg forsyning – The district heating utility company.*

Which resources were available before the project? What are local energy potentials?

- *Strong support from the Danfoss top level management*
- *Dedicated individuals with strong expertise in the field*
- *Decades of inhouse experience of energy-efficient technologies and controls.*

Who (what) were drivers and who (what) were opponents (barriers) – and why?

*The drivers were to comply with Danish climate goals, save energy, free resources, increased resilience and competitiveness and to develop a state-of-the-art demonstration case on how energy efficiency can be achieved in existing industry campuses. The main barrier was to achieve the demonstration goal that great energy savings can be achieved with strict*

*financial constraints. In this case, the maximum return on investments was considered to be 4 years. The reason for the financial barrier was to create a showcase of energy savings that all industries should be able to accept. A second main barrier was that the energy improvements should not affect the processes and day-to-day operations of the facility.*

What was finally the crucial parameter for go /no-go decision?

*The crucial parameters were the fast return on investment requirement and that the improvements should not interrupt the day-to-day operation of the facility.*

#### **6.12.4.2 Financing Issues**

What have been the main challenges/constraints regarding financing?

*The main constraint regarding financing was the requirement of maximum 4 years on return on investment (ROI). After implementation, the real payback period was 3.1 years, which was above expectations.*

Which business model applies to the project?

*The projects were financed 75% by Danfoss and 25% by governmental subsidies.*

#### **6.12.4.3 Technical Issues**

What have been major technical challenges/constraints regarding system design?

*The major technical challenges have been to implement the projects without disturbing the manufacturing processes and day-to-day operations.*

#### **6.12.4.4 Design Approach Applied**

Which design targets have been set and why?

*The original target was 50% reduction, compared to 2007, in energy demand and CO<sub>2</sub> by 2030. The target has since been updated to be CO<sub>2</sub> neutral by 2030.*

*Danfoss is funding partner of the local initiative Project Zero, which is an umbrella organization for energy efficiency projects in the local community. The goal of Project Zero is to realize CO<sub>2</sub> neutrality of the Sønderborg commune in 2029.*

#### **6.12.5 Resilience**

Which threats were considered and are to be considered? Are there redundancies in the energy supply system?

*The main threat considered is national power grid failure, disruption of gas, and whether district heating would be introduced to the area. In 2019, the district heating grid was finally confirmed.*

##### **6.12.5.1 Power**

To minimize the risk in the event of failure in the national power grid, two independent national power grid connections are applied. In case of full failure of the national power grid, onsite power generation facility can be started. Due to the reliability of both the power and gas grid in Denmark, there are no onsite backup fuels for power generation.

## 6.12.5.2 Heat

Heat is not considered a vulnerability as multiple heat sources are available in the campus area; once the district heating is connected in 2020, a significant heat supply security is added, especially as the district heating biomass boiler will be located within the campus area. For short term thermal interruption, a thermal storage of 1,000 m<sup>3</sup> is located onsite. In case of longer disruptions, there is onsite gas LPG storage dimensioned for 24-hour supply at design conditions, -12 °C outdoor temperature. Further, in case of heat source failure there are couple of hours lead time before a critical situation will arise.

### What is the degree of autarky?

*The campus is dependent on having either power or gas grid connection for power generation.*

*The campus can operate the thermal supply system for 24-hours at design conditions, -12 °C, using onsite thermal storage and gas boiler fueled by gas from an onsite LPG storage.*

### Are there backup systems? On which time-scale can they be accessed?

*Heat from the onsite thermal storage can be accessed immediately and is more than sufficient to cover the demand until emergency boiler is operational.*

*Emergency power generation can be started within a minute and ramped up to 100% in little over 2 minutes.*

## 6.12.6 Lessons Learned

### 6.12.6.1 Major Success Factors

- When starting to look into the potential energy-saving measures a significantly more improvement potentials were identified than originally expected.
- Improvements were possible without interrupting daily operations.
- Energy efficiency improvements were more effective than anticipated.

### 6.12.6.2 Major Bottlenecks

There were no major bottlenecks.

### 6.12.6.3 Major Lessons Learned

The most important part for ensuring success is the involvement of affected stakeholders in identifying and realizing energy savings.

Most savings are achieved with simple improvements of existing systems and application of proper automatic control equipment.



All technologies required for energy improvements are readily available on the market. There are no missing fundamental technologies to realize significant energy savings.

### What should be transferred from this project:

*Energy savings are generally possible with small amount of investments. The technologies for realizing the energy savings are readily available.*

*Most energy savings can be realized with small investments and fast payback periods.*

## 6.13 Energy Planning in Urban Development Favrholt, Denmark

Case No.	Country	Location	Specific Type	Photo	Special points of attention
13	Denmark	Favrholt	Energy Supply System District heating and cooling in urban development		 district cooling/heatig heat pump, thermal storage
<b>Country:</b>		Denmark			
<b>Name of city/municipality/public community:</b>		Hillerød Municipality			
<b>Title of case study:</b>		Energy planning in urban development Favrholt			
<b>Author name(s):</b>		Anders Dyrelund			
<b>Author email(s):</b>		ad@ramboll.com			
<b>Link(s) to further project related information/publications, etc.:</b>		<a href="http://www.favrholt.dk/media/262641/strategisk-energiplan-for-favrholt.pdf">http://www.favrholt.dk/media/262641/strategisk-energiplan-for-favrholt.pdf</a>			

### 6.13.1 Background and Framework

The city of Hillerød in Denmark is a local community of around 33,000 inhabitants. Almost all the buildings in the city are connected to the district heating system, and in the outskirts of the city some districts are supplied with natural gas and there is not yet district cooling in the city. South of the city the municipality is planning a new urban development area including a new S-train station and a new main hospital for the region. The new green-field area is neither approved for district heating or gas, and it is therefore an open question how to establish the supply of heating and cooling.

According to the Heat Supply Act, the municipality is obliged to work with heat supply planning in cooperation with local stakeholders to ensure the most cost effective supply for the society. The municipality can ask energy utilities to prepare business plans to be assessed and approved/rejected by the municipality in accordance with the law, or alternatively, the utilities or the municipality can prepare proposals on their own initiative. To get an overview of the best options for heating and cooling for the new urban development area and thereby to define any projects and business plans of interest (and from which utilities), the municipality prepared a **strategic energy plan**. According to this plan, district heating and cooling in interaction with the district heating in the city will be the best solution. This recommendation has been approved by the city council and is now going to be implemented. The first project is an energy plant to supply the hospital and connection to the city district heating system. Figure 78 shows the urban development area (highlighted) south of the city, with the hospital and a new city center close to the station in the eastern end of the area.



**Figure 78. The new urban development area Favrholt (Source: Hillerød Municipality).**

### **6.13.2 Energy Objectives**

The objective for the local authority is, as the planning authority for heat supply, in accordance with the obligation in the Heat Supply Act, to ensure that the heat supply to the new urban district will be the most cost effective for the society of Denmark.

As a local government, a second objective was to facilitate the most cost-effective, reliable, and environmentally friendly supply of energy services to the whole city of Hillerød, considering the symbiosis between the new city district and the rest of the city.

### **6.13.3 The Planning Process and Methodology**

The production of district heating will normally be defined at the cost of extending the supply form the city to the new city district, including EnergyPro analysis with and without the new district. In this case, the heat supply of the city is in a transition from 100% gas CC/CHP to a mix of biomass CHP, biomass boilers, solar, heat pumps, and electric boilers, including the use of gas boilers as backup. There is no existing district cooling. Therefore, the production dimension will be divided into two parts:

- First, to establish production of district heating and cooling in symbiosis for the district alone without interconnection with the city district heating.
- Second, to establish an interconnection for the exchange of heat for storage and to supply backup capacity from the existing district heating boilers.

The first production alternative is therefore to establish an energy plant with heat pumps for combined district heating and cooling with chilled-water storage, ground source cooling, and a backup boiler for heating

The second is to use the existing district heating including heat storage and backup boilers and thereby save investments and to benefit for exchange heat in between the energy plant and the district heating system.

The CBA model will be prepared for comparing the scenarios.

Next is the preliminary design of the new networks for district heating hot water and district cooling, based on the GIS information on the map, consumer database and the production scenario. As a first estimate to calculate realistic lengths of the network, the pipe trench will be defined by the planned roads, which interconnect the buildings. The trench and the heat loads will be transferred automatically to the hydraulic model.

In the general case, the hydraulic analysis will focus on critical load cases, such as

1. Peak load case: including all production plants
2. Base load case: maximal use of a centralized base load combined with a decentralized peak load
3. Critical load case: production in case of a critical disruption, e.g., breakdown of a pipe, which cannot be repaired urgently
4. Low load case: to analyze possible problems with temperature drop for heating in summer.

In this case, it was sufficient to use load case 1, not least because the plant was located very close to the only critical consumer, which is the hospital.

If other critical consumers in the network are located far from the plant or if they have critical process cooling, consideration will be given to establishing a peak production plant, a chiller, or a boiler to serve both as spare capacity for this consumer and as peak capacity for the whole system.

The hydraulic model will give a list of pipe lengths and dimensions to be included in the CBA model.

Next is the formation of annual load profiles for heating and cooling demand, hour by hour and simulation of the load dispatch hour by hour by a model, in this case EnergyPro.

In the very first stage, a simple standard duration curve for heating and cooling (in which the demand is sorted from largest to smallest,) is used. This gives a good overview, which in this case was sufficient for a preliminary estimate of the base load and peak load capacities.

In the second stage, and in particular because the electricity prices fluctuates, the production was simulated with EnergyPro hour by hour. It should in principle be for be 20-year period, but for practical reasons only for the years in which there is significant changes in the production capacity and demand.

The result of the load dispatch as well as average electricity prices for units, which use or produce electricity is transferred to the CBA model.

Based on all data from the consumer data base, the hydraulic analysis and the load simulation, all total energy flows and costs are calculated in the CBA model for each scenario.

For each utility that includes calculation of energy balance, costs, and revenues:

- Forecast for development of network in each district and connection of consumers
- Heat loss of the network divided on districts based on temperatures, list of pipe length and dimensions and standard heat loss
- Energy balance of demand and production as well as fuel consumption and emissions
- Investment cost of the network divided on districts based on list of pipe length and dimensions as well as an assessment of the trench with regard to conditions (open field, small road, heavy road, difficult crossing etc.)



- Costs and revenues for the supply alternatives and the baseline alternatives for the selected districts and production plants including
  - Investments cost minus residual value for lifetime > 20 years, e.g., network
  - Annual operation maintenance cost
  - Fuel and electricity costs
  - Revenues for sale of heat, cold and electricity.

For each consumer divided by districts, the following are calculated:

- Energy data for maximal capacity and annual energy demand for comfort heating and cooling and process heating and process cooling
- For each alternative supply form, e.g.,
  - District heating
  - Gas boiler
  - Individual heat pump
  - Individual solar water heating
  - District cooling
  - Individual chiller and free cooling
- The following costs are calculated:
  - Cost for connection to DH&C or investment in individual plant
  - Annual energy costs
  - Annual operation and maintenance cost.

For all utilities, heat consumers and cooling consumers, the total annual costs are calculated.

Thereby it is possible to calculate the NPV for each alternative and to calculate the internal rate of return (IRR) compared to the base line, where it has been defined.

With regard to the district cooling, the IRR may not be defined, as the total investments for all consumers in the baseline often is larger than the total investments in the supply alternative.

Finally it is possible to summarize the NPV benefit for all stakeholders including the consumer groups in the local community, to facilitate that the stakeholders identify the solution that is the best for all.

Figure 79 shows the interaction between the economic model and the submodels for GIS data, buildings, and consumers, in a simulation with Energy Pro and a hydraulic analysis.

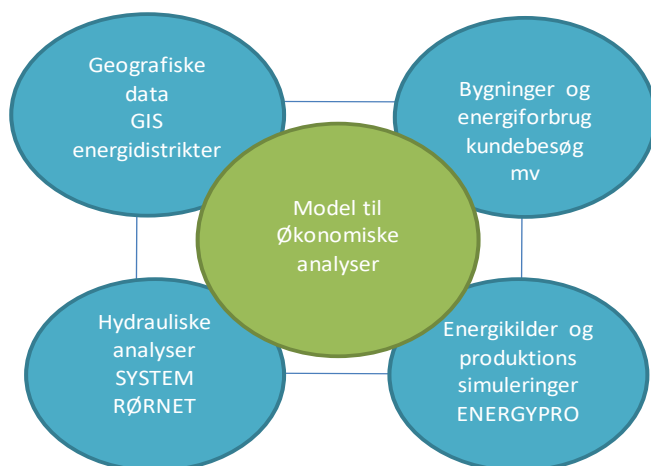

**Figure 79. Diagram of interaction between models.**

Finally, the economic model can include a financial analysis for the utility that is going to invest in the infrastructure including depreciation and financial options (see Tables 25 to 27.).

Figure 80 shows the district heating network from hydraulic analysis in all districts.

**Table 25. Additional information of energy planning in urban development Favrholm.**

<p>Building mix in the area: Mix of one large hospital, medium size buildings and single-family</p> <p>Heating</p> <ul style="list-style-type: none"> <li>• 600,000 m<sup>2</sup>, 1,500 buildings</li> <li>• Heat Demand: 12 MW, 24 GWh</li> <li>• Base line: Individual heat pumps,</li> <li>• DH scenarios in steps <ul style="list-style-type: none"> <li>○ DH from central heat pump</li> <li>○ Cogeneration from heating and cooling</li> <li>○ Ground source ATES</li> <li>○ Heat storage tank</li> <li>○ Integration with existing DH.</li> </ul> </li> </ul>
---

**Table 26. No of heat consumers, floor area, and heat demand by district.**

Nr	Hillerød Kommune Energiområde	Antal kunder	Areal	Behov	Behov
			m2	MWh	kWh/m2
1	Salpetermosefinger	4	12.500	500	40
2	Roskildevejfinger	234	30.540	1.222	40
3	Smørkilddegårdfinger	53	77.304	3.092	40
4	Solrødgårdfinger	213	95.160	3.806	40
5	Brødskovfinger	231	34.410	1.376	40
6	Hestehavefinger	483	112.577	4.503	40
7	Serviceområde	5	19.500	780	40
8	Hospitalsområde	1	120.000	6.000	50
9	Stationsområde	327	73.200	2.928	40
10	Hovedledning uden behov	0	0	0	0
<b>I alt</b>	<b>I alt</b>	<b>1.551</b>	<b>575.191</b>	<b>24.208</b>	<b>42</b>

**Table 27. Summary of district heating investments by district.**

6 bar 30 °C Investering i net og stik	Distribution m	Stik m	Net i alt m	Distribution 1.000 kr	Stik 1.000 kr	Net i alt 1.000 kr
Salpetermosefinger	222	0	222	563	0	563
Roskildevejfinger	4.949	1.404	6.353	13.039	3.257	16.296
Smørkildefinger	2.277	240	2.517	7.140	811	7.951
Solrødgårdfinger	3.716	1.158	4.874	12.139	3.913	16.052
Brødskovfinger	3.949	1.374	5.323	11.383	4.643	16.026
Hestehavefingre	3.433	2.826	6.259	9.229	9.549	18.778
Serviceområde	518	0	518	1.459	0	1.459
Hospitalsområde	121	0	121	535	0	535
Stationsområde	1.896	1.908	3.804	5.342	6.447	11.789
Hovedledning	1.049	0	1.049	7.246	0	7.246
<b>I alt</b>	<b>22.130</b>	<b>8.910</b>	<b>31.040</b>	<b>68.075</b>	<b>28.620</b>	<b>96.695</b>



**Figure 80. District heating network from hydraulic analysis in all districts (Source: Ramboll and Hillerød Municipality).**

#### 6.13.4 Technical and Organizational Highlights

Figure 81 and the data in Tables 28 and 29 describe the district cooling network at Favrholt, Denmark.



Figure 81. District cooling network from hydraulic analysis to all buildings that have a cooling demand (Source: Ramboll and Hillerød Municipality).

Table 28. Number of cooling consumers, floor area, and cooling demand and capacity demand by district.

- 400,000 m<sup>2</sup>, 62 buildings
- Cooling demand: 13 MW, 16 GWh
- Base line: Individual chillers
- DH scenarios in steps
  - DH from central chiller, same technology
  - Cogeneration from heating and cooling
  - Chilled water storage tank
  - Ground source ATES.

Nr	Overskudsvarme fra fjernkøling i Favrholm Hillerød Kommune Energiområder	Antal kunder	Areal iht. BBR m <sup>2</sup>	Kølebehov i gennemsnit for hvert område				
				Enhedsforbrug		Energi	Max timer	Effekt
				kWh/m <sup>2</sup>	W/m <sup>2</sup>	MWh	timer	kW
1	Salpetermosefinger	0	0	0	0	0	0	0
2	Smørkildefinger	13	72.504	24	30	1.764	800	2.205
3	Solrødgårdfinger	20	75.000	24	30	1.800	800	2.250
4	Brødeskovfinger	2	4.500	28	35	126	800	158
5	Hestehavefinger	12	59.297	24	30	1.430	800	1.788
6	Serviceområde	5	19.500	24	30	468	800	585
7	Hospitalsområde	1	120.000	84	42	10.080	2.000	5.040
8	Stationsområde	9	41.400	24	30	994	800	1.242
<b>I alt</b>		<b>62</b>	<b>392.201</b>	<b>42</b>	<b>34</b>	<b>16.662</b>	<b>1.256</b>	<b>13.268</b>

**Table 29. District cooling network.**

Dimension DN	Enhedspris kr/m	Distribution m	Stik m	Distribution 1.000 kr	Stik 1.000 kr	Investering 1.000 kr
DN65	3.440	1.055	0	3.628	0	3.628
DN80	3.830	998	0	3.821	0	3.821
DN100	4.439	1.215	0	5.396	0	5.396
DN125	5.238	788	0	4.128	0	4.128
DN150	5.413	542	0	2.932	0	2.932
DN200	7.618	563	0	4.291	0	4.291
DN250	9.981	1.172	0	11.694	0	11.694
DN300	12.044	671	0	8.078	0	8.078
DN350	14.047	0	0	0	0	0
DN400	15.304	30	0	451	0	451
<b>Køleprojekt</b>	<b>normal</b>	<b>8.430</b>	<b>0</b>	<b>48.783</b>	<b>0</b>	<b>48.783</b>

#### 6.13.4.1 Strong Symbiosis between District Heating and District Cooling

The integrated DH&C solution is the most profitable for the society and for the local community compared to individual building-level solutions.

- The investments in the DH&C solution and the investment in the baseline, which is building-level heat pumps and chillers are almost equal, but
- The DH&C with the thermal storage and conversion technologies can react on the electricity prices, offer a significant demand response, and act like it there was installed a battery (a virtual battery)
- The DH&C is a more resilient solution as several sources can be used for heating and cooling and combined (Table 30))
- The DH&C is also more environmentally friendly in the local environment as regarding noise and visual impact
- Taking all into account, the NPV benefit of the DH&C is around 30 mill (Table 31). Euro compared to the building-level solutions.

**Table 30. Technical data for network and production capacity.**

<b>Optimized DH&amp;C to the district</b>		<b>DH</b>	<b>DC</b>
Length of network and branch lines	km	35	10
DH storage tank, rough estimate	m <sup>3</sup>	7000	
DC storage tank	m <sup>3</sup>		3500
Capacity demand to network	MW	12,0	11,0
Capacity leveling of storage	MW		3,0
Ground source cooling	MW		3,0
Gas boiler for peak	MW	5,0	
Total installed heat pump for DH&C	MW	7,0	5,0
<b>Total installed capacity</b>	<b>MW</b>	<b>12,0</b>	<b>11,0</b>
Necessary electric capacity	MW	2	
Total COP for cogen of DH&C	MW/MW	(7+5)/2 = 6	

**Table 31. Total costs of individual scenario and combined scenario.**

<b>Investment in base line</b>		<b>Heating</b>	<b>Cooling</b>	<b>Total</b>
<b>Individual heat pumps / chillers</b>	<b>mio.Euro</b>	<b>20</b>	<b>19</b>	<b>39</b>
<b>Investment in DH&amp;C system</b>				
		<b>DH</b>	<b>DC</b>	<b>DH&amp;C</b>
DH&C networks	mio.Euro	20,0	7,9	27,9
DH&C storages	mio.Euro	1,6	0,8	2,4
DH&C boiler / ground source cooling	mio.Euro	0,7	1,1	1,7
DH&C heat pump for DH&C	mio.Euro	5,5		5,5
<b>Total DH&amp;C</b>	<b>mio.Euro</b>			<b>37</b>

The data in Tables 32 to 34 demonstrate the profitability for the society including cost of CO<sub>2</sub> and harmful emissions but excluding taxes (in accordance with the guidelines and price forecast from the Energy Agency) and for the local community including taxes based on today's commercial energy prices.

The data in Table 32 show that there is a huge benefit integrating the district heating with the cooling and with the city district heating system, e.g., that the available capacity in the city can be backup for the heat pump. It also shows the advantage of maximal connection of all buildings to the network.

**Table 32. Profitability for the district heating part.**

<b>Profitability of the district heating compared to individual heat pumps</b>	<b>For the society</b>		<b>For the local community</b>	
	100% mill.DKK	70% mill.DKK	100% mill.DKK	70% mill.DKK
Connection 100% or 70% to the grid				
<b>District alone without integration with cooling</b>	<b>90</b>	<b>48</b>	<b>115</b>	<b>75</b>
<b>Integration with cooling and the city</b>	<b>124</b>	<b>73</b>	<b>159</b>	<b>107</b>

The data in Table 33 show that the benefit of district cooling with ground source cooling alone and compared to individual chillers at the building level. Also for district cooling it is vital for the cost effectiveness that all buildings are connected.

**Table 33. Profitability for the district cooling part.**

Profitability of district cooling only compared to individual chillers, no integration Connection 80% or 60% to the grid	For the society		For the local community	
	80% mill.DKK	60% mill.DKK	80% mill.DKK	60% mill.DKK
<b>Fjernkøling med grundvandskøling</b>	<b>55</b>	<b>18</b>	<b>65</b>	<b>31</b>

Finally, the data in Table 34 show the benefit of the two parts of the project and demonstrate the importance of maximal connection.

**Table 34. Profitability of the whole project for combined heating and cooling.**

Profitability of integrated DH&C project DH&C with ground source cooling	For the society	For the local community
	mill.DKK	mill.DKK
<b>Large connection rate</b>	<b>179</b>	<b>224</b>
<b>Low connection rate</b>	<b>91</b>	<b>138</b>

Figures 82 and 83 show the load profile of heating and cooling

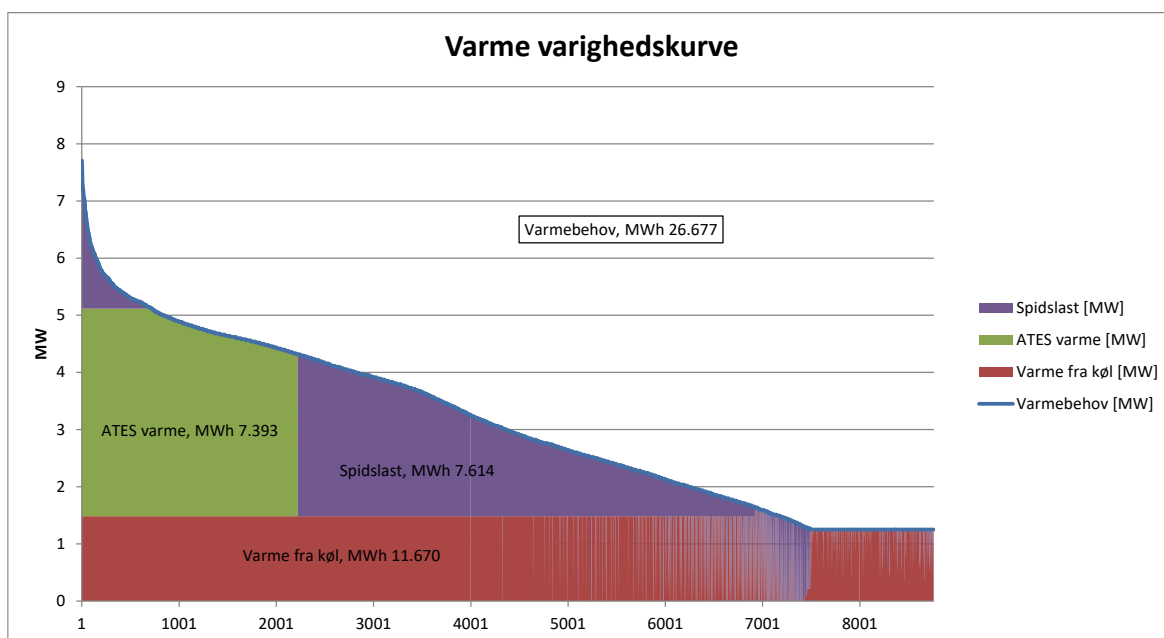

**Figure 82. Simple heat duration curve for the district heating in the district (sorted hours).**

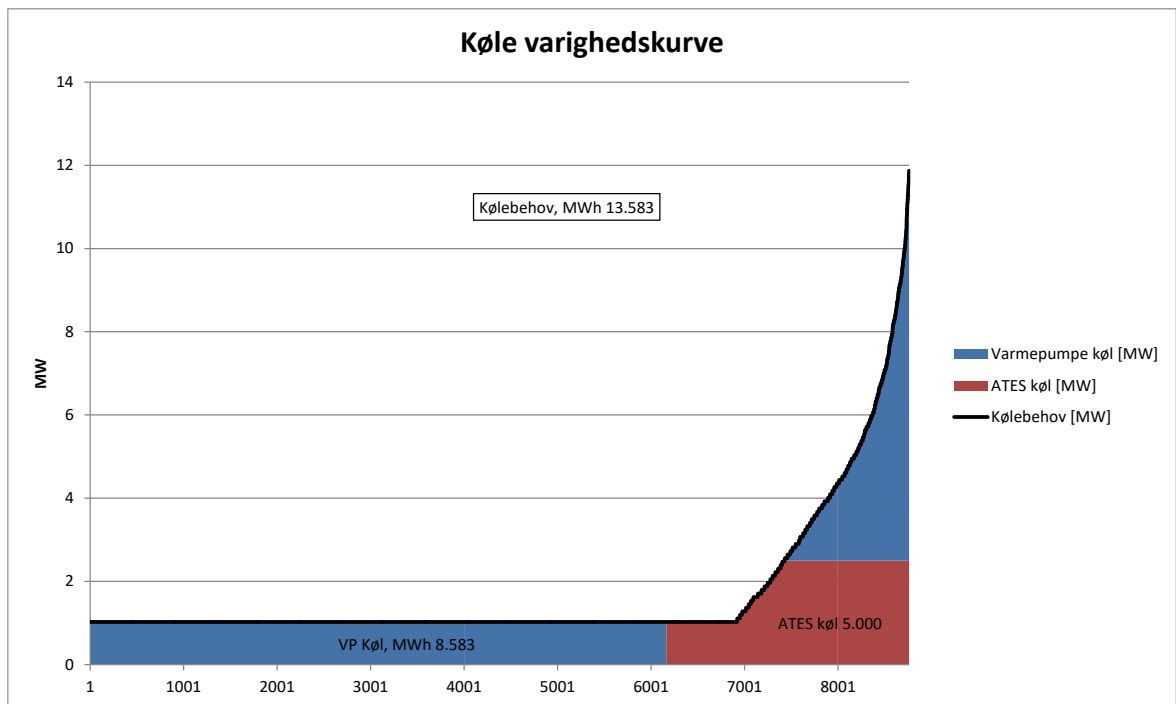

Figure 83. Simple load profile for the district cooling supply (sorted hours).

## 6.13.5 Decision and Design Process

### 6.13.5.1 General/Organizational Issues

#### Why was the project initiated?

*The local authority has an obligation to work with heat planning, and therefore it was important to include the planning of the energy infrastructure for heating in the urban planning of the whole urban development area.*

*The local authority is also elected to serve the interest of the residents and all landowners and business in the municipality, and therefore it is important to consider the best energy solutions in the urban planning and facilitate that the most logic energy utilities take part in this process.*

#### Who were the major stakeholders?

- *The public utility of Hillerød, district heating branch*
- *The public utility of Hillerød, a new district cooling branch*
- *Major land owners and developers in the new city district, not least the hospital*
- *The power distribution company, in case individual heat pumps will be the preferred solution*

#### Which stakeholders were involved in the project?

*The public utility of Hillerød was involved in meetings.*

*The hospital was involved indirectly via regular contact with the municipal planning authority.*

#### Which resources were available before the project? What are local energy potentials?

- *A district heating transmission line to Hillerød district heating crosses the district and is connected to an 80 MW gas-fueled CC plant and a 16,000 m<sup>3</sup> heat storage tank. This is an opportunity to use the storage tank and exchange heat with the network.*



- *The CHP plant is going to be closed as it is not cost effective to reinvest in it, but the space around it could be perfect for a new heat pump installation.*
- *There is excellent resources for ground source cooling, which could be explored.*
- *West of the district there is a wastewater treatment plant and a district for pharmaceutical industry, which in the longer term could be connected to the district.*

Who (what) were drivers and who (what) were opponents (barriers) – and why?

- *The city council and the city administration wanted this study.*
- *There were no opponents, as it was urban development area in which natural gas is not an option.*
- *In case the strategic energy plan had included a natural gas supplied district, west of Favrholt, the gas company would have been an opponent.*
- *This conflict of interest can in a later stage be handled in a separate project proposal in accordance with the Heat Supply Act.*

What have been the main challenges regarding decision finding?

- *This overall plan has been approved by the city council, but it is not legally binding. It gives an overview of the most profitable final solution and has to be implemented by more detailed project proposals from energy utilities to be assessed by the city council in accordance with the regulation in the Heat Supply Act. Thus, the city council has the back ground for assessing incoming project proposals.*
- *The plan does not specify which utility shall submit project proposals for the district heating and implement district heating and cooling, but the most likely is the public utility of Hillerød, which supplies the rest of the city. It is important that the same utility establish both district heating and cooling and that the project starts with the first and largest consumer, namely the hospital.*
- *In that regard, it has been a challenge that the hospital has not been willing to negotiate contract for cooling with the local utility, but called for a tender.*

### **6.13.5.2 Financing Issues**

The supply of district heating will be supplied 100% by low interest loans as the municipality will guarantee for loans for the heat supply, including heat pump installations.

The utility and the consumers will have to share the financing for the district cooling network and chilled-water tank.

Which business model applies to the project?

- *The public utility will invest in district heating, and also in heat pump installations and consumer installations, and collect connection fee and annual payments including a variable fee for energy and fixed fee for fixed costs. In the longer term, the heat supply of the district will contribute to a lower heat price for all heat consumers in Hillerød.*
- *It is most likely that the public utility will develop the combined district heating and cooling and be able to offer a competitive supply of cooling to the hospital. The tariffs for cooling will be a significant connection fee and a minor annual payment for energy and capacity reflecting the cost structure of the individual cooling.*
- *According to the strategic energy plan, there will be a total economic benefit for district heating and cooling, in particular due to the symbiosis between the two systems and the use of ATES.*
- *The new hospital is the first large consumer that is important for the success of the project.*

- *The district heating branch of the local public utility has prepared a project document for supply of district heating in accordance with the Heat Supply Act and the municipality has approved the project.*
- *The hospital and a new district cooling branch of the public utility have entered a commercial contract for supply of district cooling to the hospital; in August 2019, the utility was preparing a project document for investment in a heat pump for combined heating and cooling, which in combination with ground source cooling will supply heat to the district heating and cooling to the new district cooling network in combination with a chilled-water tank and ground source cooling.*

### **6.13.5.3 Technical Issues**

What have been major technical challenges/constraints regarding system design?

*It has been a challenge to find an agreement between the municipally owned public utility and the regional owned new hospital with regard to the technical concept for connection. Finally, it was agreed that there was no need to separate the networks for district heating from the internal heating system of the hospital via heat exchangers and, likewise, that there was no need to separate the network of the district cooling from the internal cooling network in the hospital,*

What solutions have been considered for generation, storage and load management?

*Individual building-level heat pumps for heating and chillers for cooling have been compared with a central plant for combined heating and cooling with ground source cooling as the most suitable site and in combination with the existing DH system with backup boilers and a large heat storage tank.*

### **6.13.5.4 Design Approach Applied**

Which design targets have been set and why?

*The criteria has been to find the most cost-effective solution for the society and the local community, in particular with regard to the zoning of the grids. In this case, district heating was more cost effective in all districts; however, in the district with single family houses, individual ground source heat pumps were almost as cost-effective. If development is uncoordinated, there is a risk that more than 30% will not connect and that will reduce the benefit of district heating to zero.*

### **6.13.6 Resilience**



The supply of district heating and cooling is more resilient than individual solutions as there are several sources and storages and as leaks in the network can be identified via surveillance system and repaired within 24-hours. At the hospital, there is backup for electricity and cooling for critical functions.

### **6.13.7 Lessons Learned**

The study demonstrate that the urban planning authority has the opportunity to identify overall cost-effective solutions already in the early beginning of the implementation and thus pave the way for utilities to be ready to offer the opportunity to developers and building owners at an early stage.

It also demonstrates that energy planning in line with planning of water, wastewater and transport is an important part of urban development and spatial planning in modern cities.

## 6.14 Gram District Heating Solar Heat, Storage Pit, Denmark

Case No.	Country	Location	Specific Type	Photo	Special points of attention
14	Denmark	Gram	Energy Supply System District heating in a small town		  thermal storage, district heating
<b>Country:</b> Denmark <b>Name of city/municipality/public community:</b> Gram in Haderslev Municipality <b>Title of case study:</b> Gram district heating solar heat, storage pit <b>Author name(s):</b> Anders Dyrelund <b>Author email(s):</b> ad@ramboll.com <b>Link(s) to further project related information/publications, etc.:</b> <a href="http://www.gram-fjernvarme.dk/">http://www.gram-fjernvarme.dk/</a> <a href="https://ec.europa.eu/jrc/en/publication/efficient-district-heating-and-cooling-markets-eu-case-studies-analysis-replicable-key-success">https://ec.europa.eu/jrc/en/publication/efficient-district-heating-and-cooling-markets-eu-case-studies-analysis-replicable-key-success</a> , case 2 in this report.					

### 6.14.1 Background and Framework

The town of Gram in Denmark is a small community of around 2,500 inhabitants. Almost all the 1,200 buildings in the town are connected to the district heating system and thereby co-owner of the consumer-owned district heating company Gram Fjernvarme Amba.

This project in Gram is a fully commercial project that demonstrates that is possible to get more than 50% of the heat from solar (Figure 84) in the Danish context without subsidy, in which taxed gas is the alternative.



**Figure 84. Gram district heating solar heating and heat storage pit (Source: Gram Fjernvarme).**

### **6.14.2 Energy Objectives**

The main objective of the company is to produce and deliver energy in Gram, but the company may offer technical and administrative services for other suppliers.

The development of the company including the extension of the supply area is the responsibility of the board and will be in accordance with the legislation.

As the consumers are the owners, who elect the board, the focus is to offer a resilient and cost-effective heat supply to all the connected buildings.

### **6.14.3 The Historical Development**

The company was founded 60 years ago and started to distribute heat from a large heavy oil boiler, which was cheaper and more convenient than individual oil boilers or solid fuel boilers.

The first established network was in concrete ducts, which were expensive and unreliable due to risk of corrosion and losses. As the preinsulated pipes were introduced 30 years ago it was cost effective to expand the system to most of the town (green area in Figure 85) and replaced the old pipes.

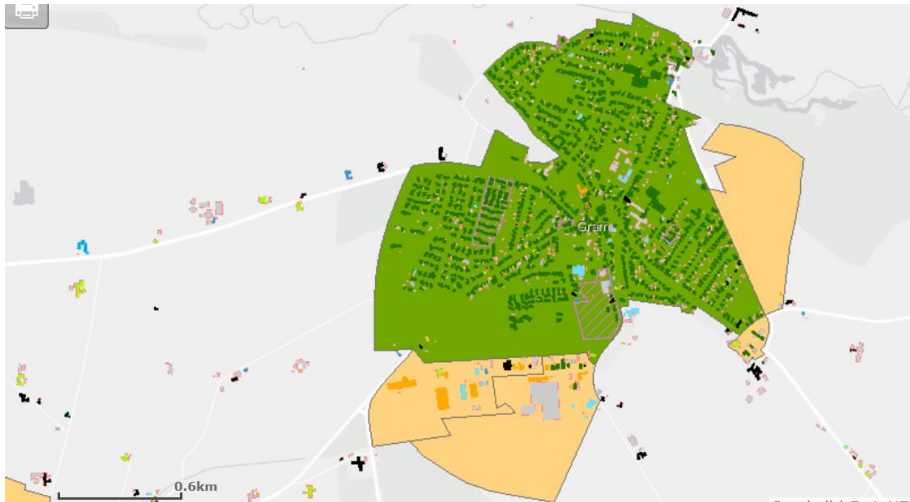

**Figure 85. Map of district heating zone (green) and gas boiler zone (yellow) (Source: Gram Fjernvarme).**

In the past 30 years, the production has developed in following steps:

- The district heating boiler were converted from heavy oil to natural gas.
- A gas-fueled CHP engine and a heat storage tank was established as base load the gas boilers remained as backup.
- A solar heating plant was established to cover up to 20% of the heat production as the existing heat storage tank could level the daily fluctuations.
- Installations for use of surplus heat from a factory was established.
- A heat pump for use of surplus heat was established.
- A 10 MW electric boiler was established to use low price electricity and enter the market for regulation.
- The solar water heating was extended to supply more than 50% of the heat production in combination with a heat storage pit..

Parallel to this improvement of the heat production, the network has been extended to supply almost all buildings in the local community.

A typical example of how the plant can react on the power market is when the electric boiler operates a few hours around noon to use surplus electricity from solar PV from Germany, which would otherwise be lost, such that the gas CHP starts operating during the evening peak period (Figure 86-88). Table 35 lists additional Information on the supply system for Favrholt, Denmark.

## EXAMPLE FROM GRAM

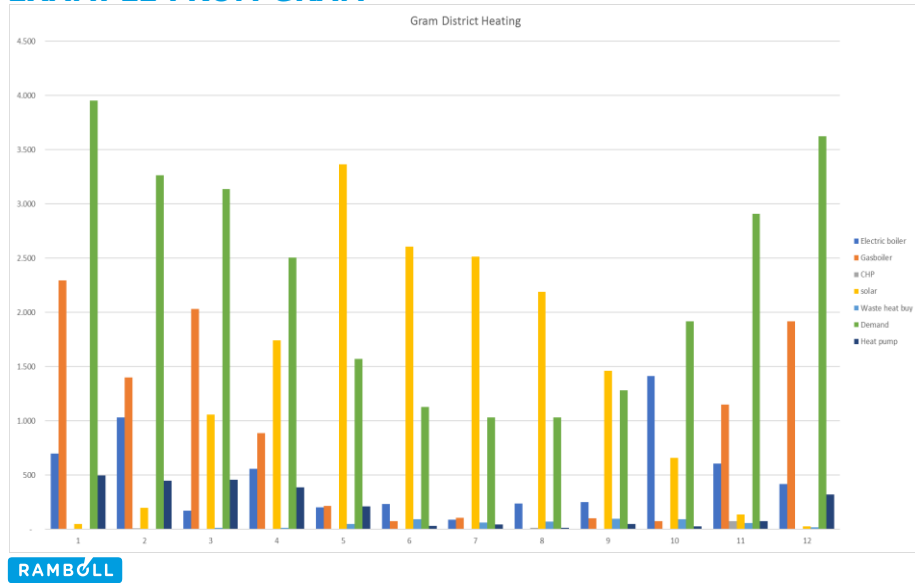

Figure 86. Operation simulated with EnergyPro (Source: Ramboll).

Table 35. Additional Information on Supply System for Favrholt, Denmark.

<b>Building mix in the area:</b>	Mainly one- family houses
<b>Consumer mix in the area:</b>	Small consumers
<b>Energy plant owner:</b>	Privately owned by heat consumers
<b>Trench length:</b>	21 km heat supply network in preinsulated pipes
<b>Heat production:</b>	28 GWh
<b>Heat demand:</b>	20GWh
<b>Heat storage:</b>	Pit of 122,000 m <sup>3</sup>
<b>Heat generation:</b>	Solar panels 44,000 m <sup>2</sup> (61%)
	Electric boiler 10 MW (15%)
	Heat pump 900 kW (8%)
	Industrial surplus heat (8%)
	5 MWe/6 MWth CHP gas engine(8%)
	Gas boilers for spare capacity (0%)

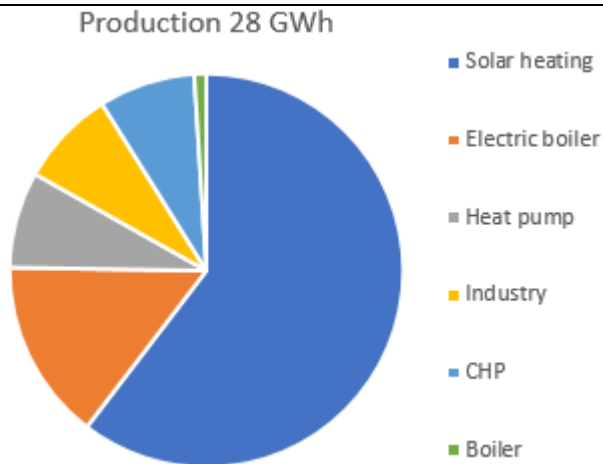

Figure 87. Heat production to the network (Source: Ramboll).



Figure 88. Investments in heat production (Source: Ramboll).

### 6.14.4 Description of a Technical Highlight

Figure 89 illustrates that the company use the potential for meeting the objectives by using the local resources, including available space for solar heating and the market conditions in the power system.

- The gas engine, the electric boiler, and the heat pump can respond efficient on the market prices in the power system.
- The electric boiler can use surplus electricity from solar PV and wind, which is sold at the market at zero or negative prices.
- The electric boiler can offer service for down regulation to the power grid (by fast upregulation).
- The CHP plant can use opportunity to generate electricity at peak prices.
- The CHP plant can offer services for upregulation to the power grid.
- The heat pumps can be connected with an obligation to disconnect in case the power grid is over loaded.

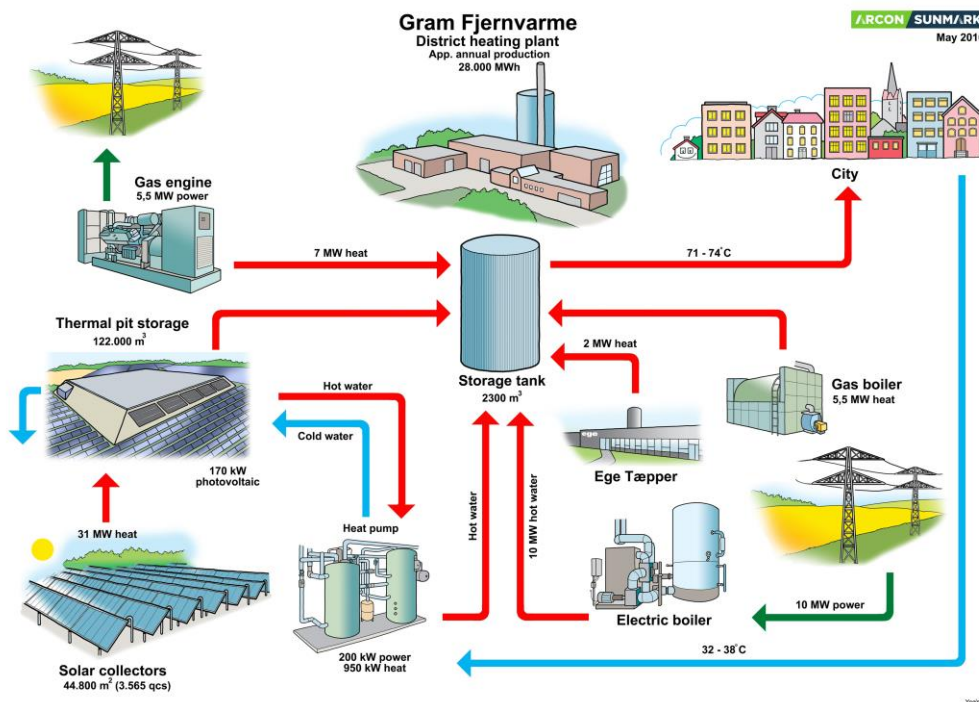

Figure 89. Gram district heating system design (Source: Gram Fjernvarme).

The potential for operating in the market has been analyzed with EnergyPro and the daily operation is optimized with Mentor Planner, which has used the data from the plant for considering the fluctuations of the solar heating.

The large storage, which is designed to level the seasonal fluctuations of the solar heating has a huge storage capacity available from mid-September to mid-April to store inexpensive heat from the CHP and the electric boiler.

## 6.14.5 Decision and Design Process

### 6.14.5.1 General/Organizational Issues

Why was the project initiated?

*To offer better comfort compared to building-level solutions*

*To reduce the heat price.*

Who were the major stakeholders?

*The district heating company.*

*A local industry, which could deliver surplus heat.*

Which stakeholders were involved in the project?

*All the stakeholders listed above had each their role.*

Which resources were available before the project? What are local energy potentials?

*Local surplus heat and solar heat.*

*The power grid transfer wind and solar PV as a resource.*

Who (what) were drivers and who (what) were opponents (barriers) – and why?

- *The main driver has been the aim of serving the consumers, who are the owners.*
- *The legislation forces the company to use expensive natural gas, as one of the national objectives was to replace oil with gas and the district heating companies were obliged to purchase gas at a price close to that of oil, which was more expensive than coal or biomass.*
- *As it became possible to establish solar heating to replace the expensive gas, the large gas price has been the driver for the solar heat and the storage.*
- *The symbiosis between CHP, electric boiler, heat pump, solar heat and storage.*

What have been the main challenges regarding decision finding?

*The extension of the solar water heating was a fully developed and concept, where the heat storage pit was among the first commercial projects of its kind. Until the plant was planned there were only one small and two large heat storage pits in operation as demonstration projects with state subsidy. This project in Gram is a fully commercial project, which demonstrates that it without subsidy is possible to get more than 50% of the heat from solar in the Danish context, in which taxed gas is the alternative.*

### 6.14.5.2 Financing Issues

The consumers pay for the heat and the municipality has guaranteed for loans to the plant.



Which business model applies to the project?

*Gram District heating coordinates the project and has contracts with consultants and contractors for storage, and (separately) with a contractor for solar heating.*

### **6.14.5.3 Technical Issues**

What have been major technical challenges/constraints regarding system design?

- *The major challenge has been to establish the insulated cover.*
- *As there were problems with the previous technology for insulation a new solution was chosen with ceramic insulation material, which was resistant against humidity and heat and could be handled and stored efficiently.*
- *Unfortunately there appeared some faults during the construction. There appeared some small holes in the top liner and water penetrated into the insulation and reduced the insulation capability.*
- *This has delayed the final implementation as it is difficult to identify all holes and as it is only possible to search in the storage in the period from January to March.*

*The next project in Toftlund, a similar district heating system in a village nearby, was constructed with careful focus on the liner and how to prevent damage. The installation was completed successful without holes in the liner, however some water penetrated into the insulation layer during a heavy rain fall. Therefore, it took some months to dry-out the insulation by ventilation.*

*Both cases demonstrate that the insulation material will not be damaged even from a combination of humidity and heat.*

*Another incident was that an additional layer of corrosion protection of the pipes, which is used in off shore constructions cannot be used in this case in warm water up to 90 °C. Therefore, the in- and outlet pipes might have shorter lifetime than 20 years and will have to be replaced. This operation is also foreseen as all pipes can easily be replaced once the storage is unloaded and the temperature is below 40 °C.*

What solutions have been considered for generation, storage and load management?

*The challenge in the operation is to use the models for planning the operation including reliable forecasts for weather and electricity prices.*

### **6.14.5.4 Design Approach Applied**

Which design targets have been set and why?

*An important target has been to ensure that the top insulation layer will be kept dry during construction and operation.*

*The dry soil around the pit is heated and in thermal balance after around 2 years of operation.*

### **6.14.6 Resilience**

The multi-source heating and the large heat storage pit offers a significant security of supply to ensure that there always is sufficient heat.

The power system is very reliable and it has not been an issue to operate the local community in island mode. However, it would in principle be possible to operate the town as a micro electricity grid and generate power from own gas engine.

Instead, the company take part in the overall regulation of the power grid like many other similar companies.



### 6.14.7 Lessons Learned

Like most other district heating companies, this project is a good model for a campus, in that it can establish its own resilient heating and power supply, but at the same have a high sustainability score; the projects are cost effective (including environmental costs) for the society and they contribute to more cost-effective energy for the local community.

The company has been a first mover with regard to new technologies in the pit storage on a large scale. This has caused some problems and reduced the economic benefit in the first years of operation.

It has however been to the benefit of the next generation of storages, e.g., a storage pit in Toftlund not far from Gram, which has learned from this experience and managed to avoid holes in the liner during the construction.

## 6.15 Nymindegab Military Camp in Denmark

Case No.	Country	Location	Specific Type	Photo	Special points of attention
15	Denmark	Nymindegab	Military camp		 <p>Biogas CHP, district heating, storage (biogas, thermal)</p>
<b>Country:</b>				Denmark	
<b>Title of case study:</b>				Resilient and renewable energy system for military camp	
<b>Location of case:</b>				55°49 North 8°11 East	
<b>Author name(s):</b>				Anders N. Andersen	
<b>Author email(s):</b>				ana@emd.dk	
<b>Author name(s):</b>				Jens Peter Sandemand	
<b>Author email(s):</b>				FES-BES25@mil.dk	

### 6.15.1 Background and Framework

Nymindegab Military Camp is situated at the west coast of Jutland in Denmark. It was initially established during World War II by the German Luftwaffe and has been rebuilt several times since then. It has training facilities at the shore.

There is no natural gas grid nearby; however the Blåbjerg Biogas plant is situated 10 km away, which makes it possible to make a resilient and renewable energy system for Nymindegab Military Camp.

There has been made a 10 km biogas pipe from Blåbjerg Biogas to Nymindgab Military Camp, and a CHP has been made at Nymindgab Military Camp, which makes it possible to cover the heating and electricity demand at the camp in island mode. The camp is shown in Figure 90 and the biogas plant is shown in Figure 91.

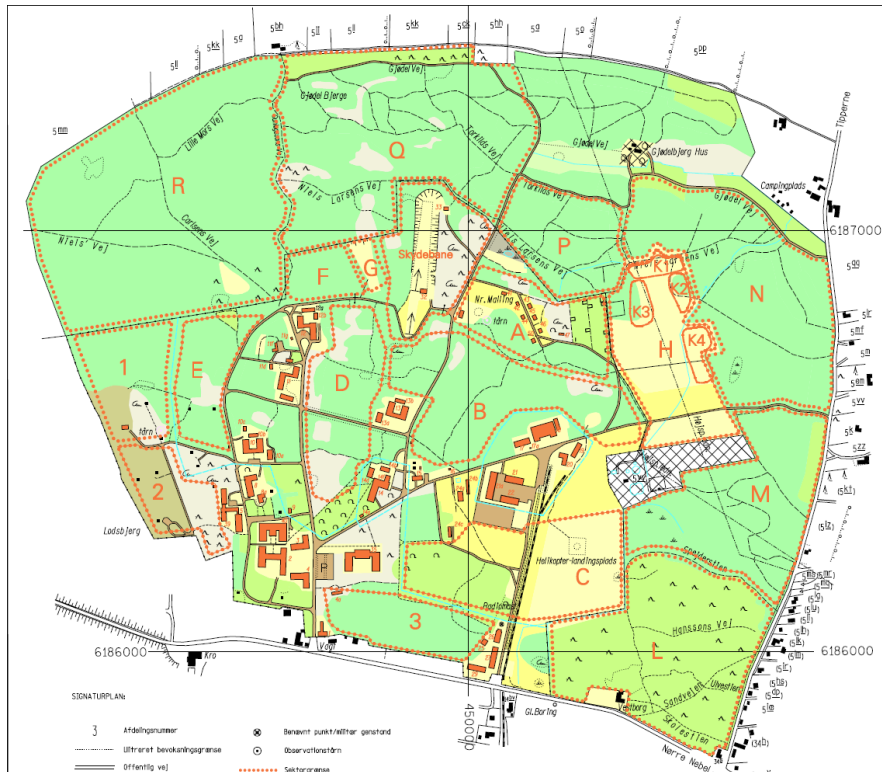

**Figure 90. Nymindgab Military Camp in Denmark (Source: © 2002 Skov- og Naturstyrelsen, Driftspankontoret og Hjemmevoernet).**



**Figure 91. Blåbjerg Biogas plant is situated 10 km from Nymindgab Military Camp (Source: blaabjergbiogas.dk).**

### 6.15.1.1 Climate Conditions at Nymindgab

In the year 2019 the average ambient temperature in Nymindgab was 10.4 °C, with a maximum temperature of 31.6 °C and a minimum temperature of -4.8 °C (Figure 92).

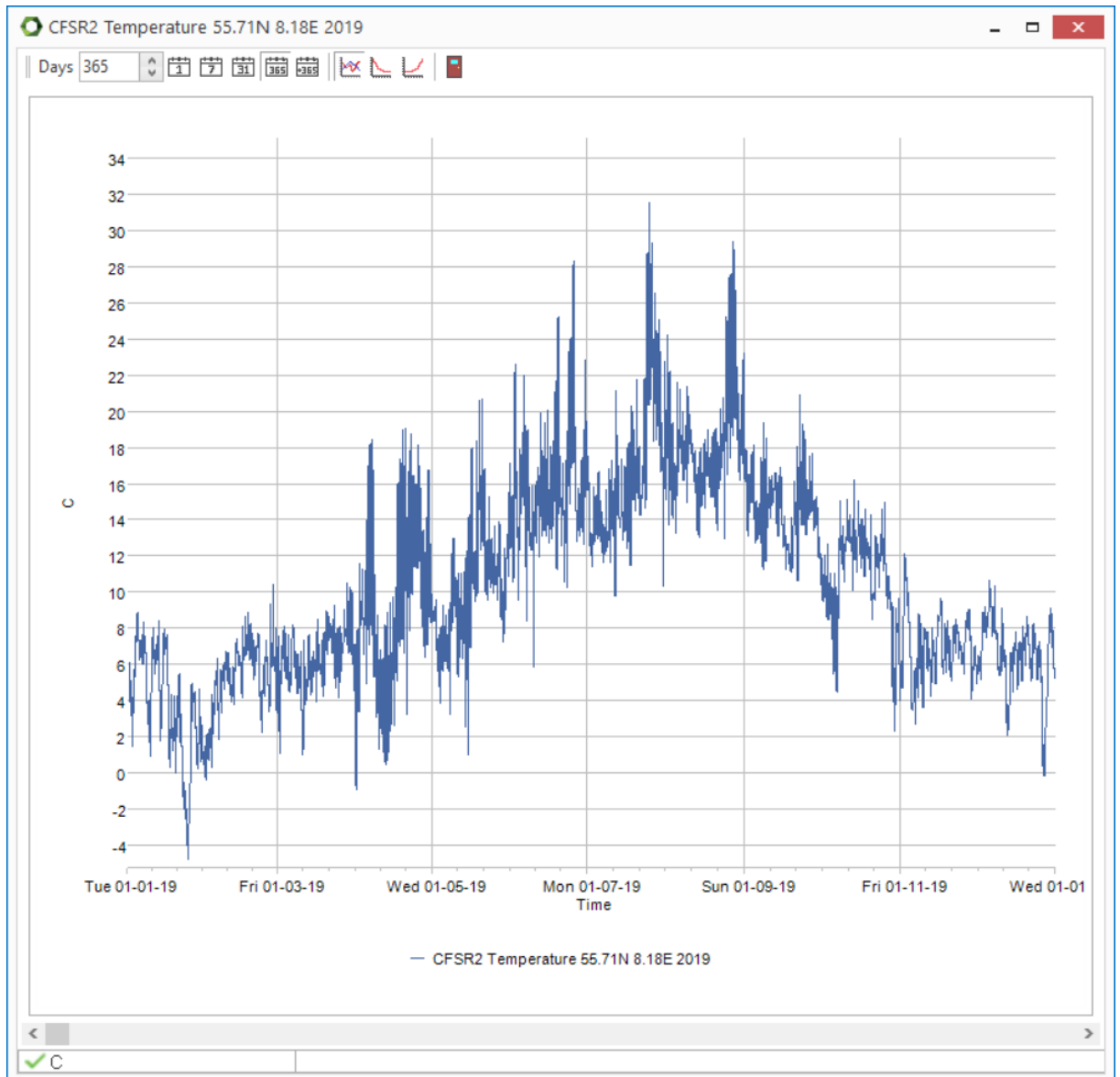

Figure 92. Ambient temperature at Nymindegab in 2019. Created with Energy system analysis tool energyPRO.

### 6.15.1.2 Heating Demand at Nymindegab Military Camp

As an example, in the year 2016 there was an estimated heating demand of 3016 MWh, with a maximum heat demand of around 0.8 MW-heat. Table 36 lists the monthly spread of the heat demand, and Figure 93 shows the duration curve for heat demand.

Table 36. Estimated heat demand in 2016 at Nymindegab Military Camp.

Estimated heat demand		
January	490 304	kWh
February	396 087	kWh
March	384 363	kWh
April	288 567	kWh
May	124 503	kWh
June	93 285	kWh

Estimated heat demand		
July	65 588	kWh
August	102 130	kWh
September	115 386	kWh
October	253 009	kWh
November	346 733	kWh
December	355 547	kWh

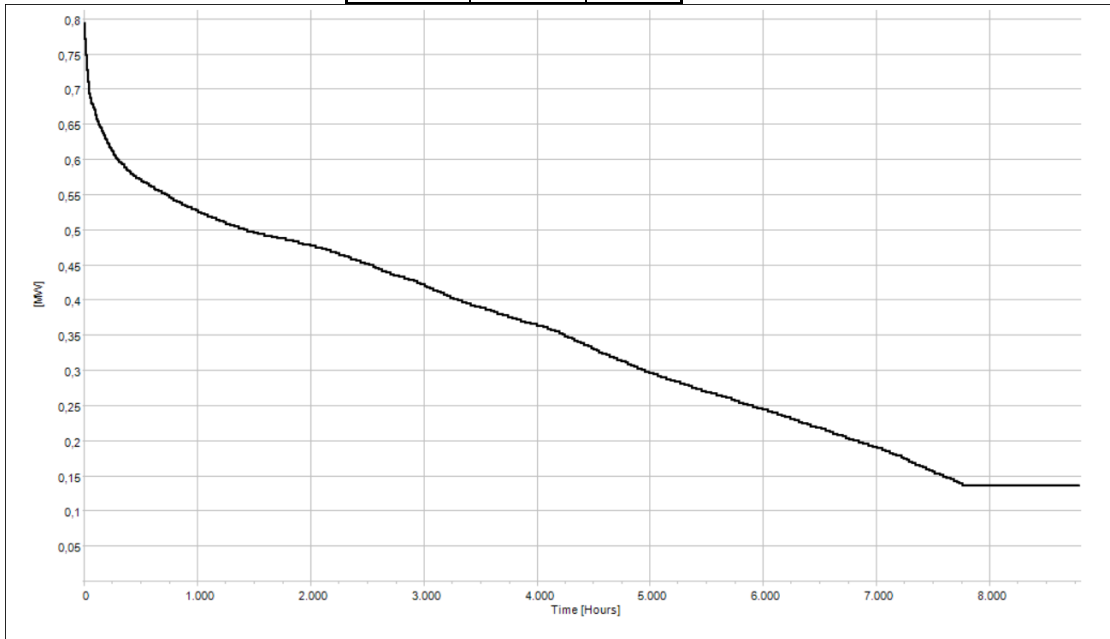
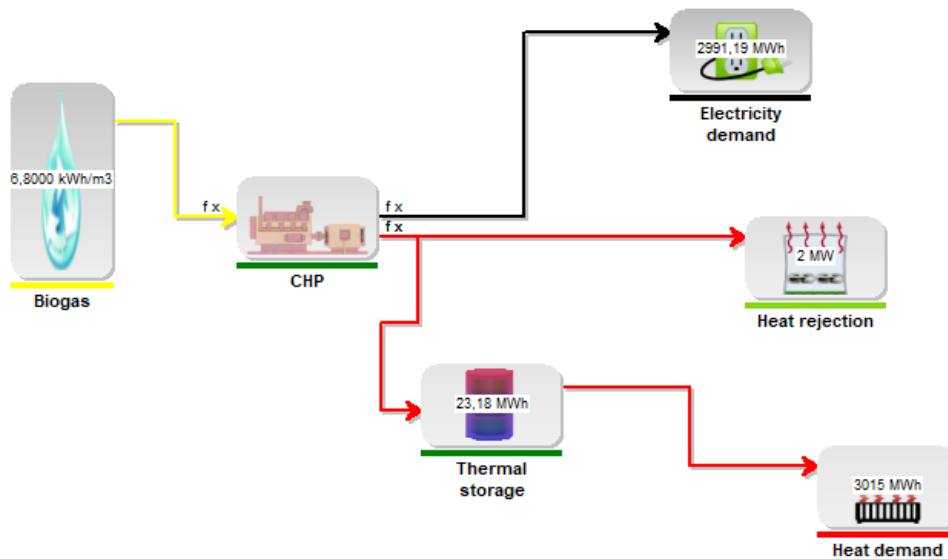

**Figure 93. Duration curve for heat demand at Nymindegab Military Camp. Created with Energy system analysis tool energyPRO.**

### 6.15.2 Resilience in the Energy System at Nymindegab Military Camp

This section analyses the resilience in the energy system at Nymindegab Military Camp. There is no natural gas grid nearby, however, a biogas plant situated 10 km from the camp delivers through a biogas pipe sufficient biogas to operate the CHP at the camp covering both heating and cooling demand at the camp.

A thermal storage and a biogas storage increase the resilience. Furthermore, when operating the CHP in island mode, covering both heating and cooling demand at the camp, a cooling tower is needed (Figure 94).



**Figure 94. A resilient energy system shown for Nymindgab Military Camp. Created with Energy system analysis tool energyPRO.**

To illustrate its resilience, Nymindgab Military Camp has been modeled in the energy system analysis tool energyPRO. Figure 95 shows simulated energy demand for 14 days in April, which illustrates the use of both a biogas storage and a thermal storage, both of which increase resilience. In the last 3 days, heat rejection in the cooling tower makes it necessary to operate the CHP in island mode covering both heating and cooling demand at the camp.

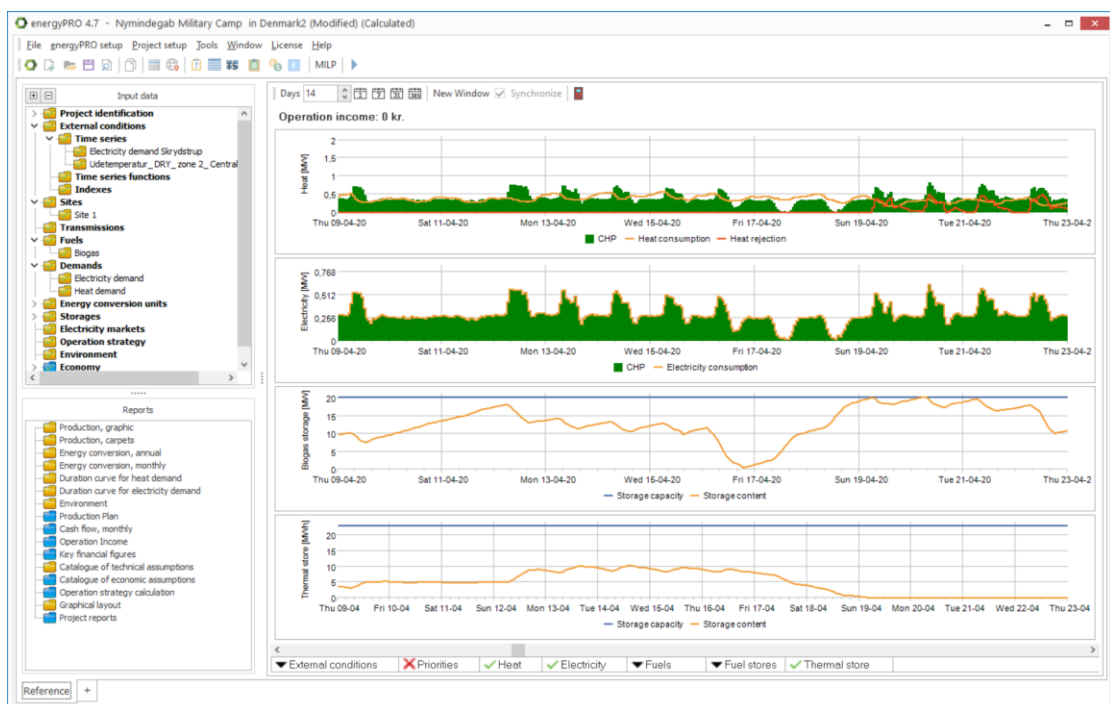
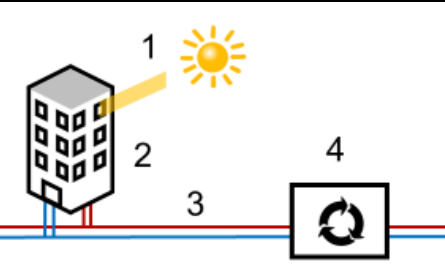



**Figure 95. The CHP at Nymindgab Military Camp simulated in 14 days in April, covering both electricity and heating demand when operated in island mode. Created with Energy system analysis tool energyPRO.**

### 6.15.3 Lessons Learned

The main lesson learned is that, even if there is no natural gas grid close to the camp, a resilient and renewable energy system has been possible for the military camp, by connecting it to nearby biogas plant (Figure 96).

### 6.16 SunZEB Building for Energy Harvesting, Finland

Case No.	Country	Location	Specific Type	Photo	Special points of attention
16	Finland	Helsinki Kalasatama	Singe Components sunZEB Building for District		 building focus, district heating/cooling, solar energy
<b>Country:</b>		Finland			
<b>Name of city/municipality/public community:</b>		Helsinki			
<b>Title of case study:</b>		SunZEB Building for energy harvesting			
<b>Author name(s):</b>		Pekka Tuominen			
<b>Author email(s):</b>		<a href="mailto:pekka.tuominen@vtt.fi">pekka.tuominen@vtt.fi</a>			
<b>Link(s) to further project related information/publications, etc.:</b>					
<b>Project report (in Finnish with English summary in the end):</b> <a href="https://www.vtt.fi/inf/pdf/technology/2015/T219.pdf">https://www.vtt.fi/inf/pdf/technology/2015/T219.pdf</a>					
<b>Helen (local energy company) presentation of the SunZEB building:</b> <a href="https://www.helen.fi/en/news/2017/energy-efficient-homes-designed-for-the-sunzeb-city-block">https://www.helen.fi/en/news/2017/energy-efficient-homes-designed-for-the-sunzeb-city-block</a>					
<b>MySmartLife project report includes a section on the SunZEB building:</b> <a href="https://www.mysmartlife.eu/fileadmin/user_upload/Deliverables/D4.2_Report_on_retrofitted_actions_and_implemented_actions_in_new_buildings_including_RES_and_storage.pdf">https://www.mysmartlife.eu/fileadmin/user_upload/Deliverables/D4.2_Report_on_retrofitted_actions_and_implemented_actions_in_new_buildings_including_RES_and_storage.pdf</a>					

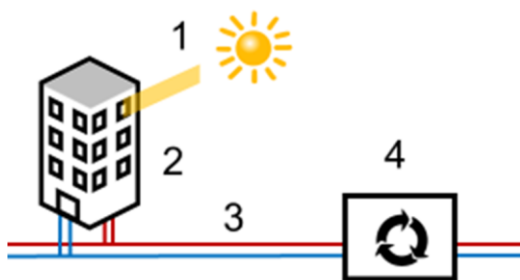
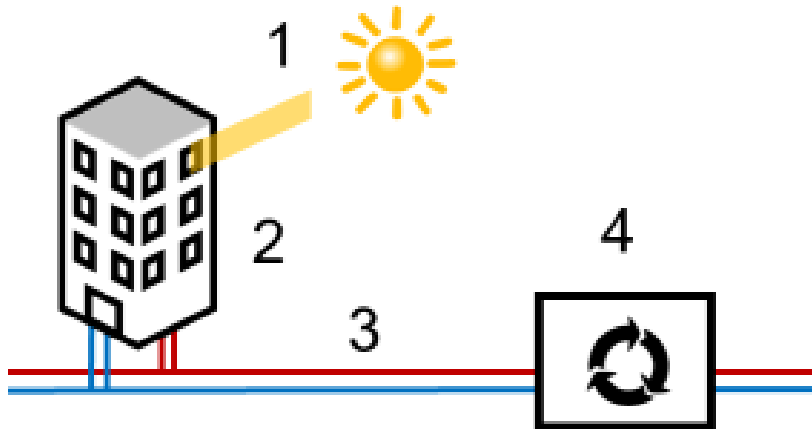

Figure 96. Operating principle of the SunZEB Building. Solar thermal flow (1) passes through the building, especially through optimized window surfaces (1). In the building (2) the cooling system collects heat energy while maintaining a comfortable indoor environment. The collected thermal energy is transferred via the district cooling network (3) to a central heat pump plant (4) of the energy company, where the heat is used, in this case to the district heating network. Source: VTT.

#### 6.16.1 Introduction and Framework

The conceptual idea of a SunZEB building is that the thermal loads of a building can be seen as part of a broader energy solution, whereby the potential overheating problem becomes a

usable energy resource. Thus the whole building can be turned into a large-scale heat collector that produces energy (Figure 97).



**Figure 97. Operating principle of the SunZEB Building. Solar thermal flow (1) passes through the building, especially through optimized window surfaces (1). In the building (2) the cooling system collects heat energy while maintaining a comfortable indoor environment. The collected thermal energy is transferred via the district cooling network (3) to a central heat pump plant (4) of the energy company, where the heat is used, in this case to the district heating network. (Source: VTT.)**

The SunZEB block (Figure 98) is located south from the district of Kalasatama in Helsinki, Finland. The block is a residential apartment building block totaling 14 200 m<sup>2</sup> for 350 residents. The SunZEB block is implemented by the real estate development companies Fira, Kojamo, and Asuntosäätiö, which are developing both rental and private owned housing. The new SunZEB building block is part of the city's Evolving Apartment Building Programme, an initiative of the city of Helsinki to increase the attractiveness, flexibility, and individual solutions of apartment buildings in the city area. The city of Helsinki has been committed to develop apartment buildings to offer individual housing solutions and to enable a competitive option to live in the capital area. The program targets are realized by granting city-owned lots to builders, whose construction projects support the common development targets. The SunZEB concept was developed in 2014-2015, the detailed planning of the building was done in 2017, and the construction took place in 2018–2020.

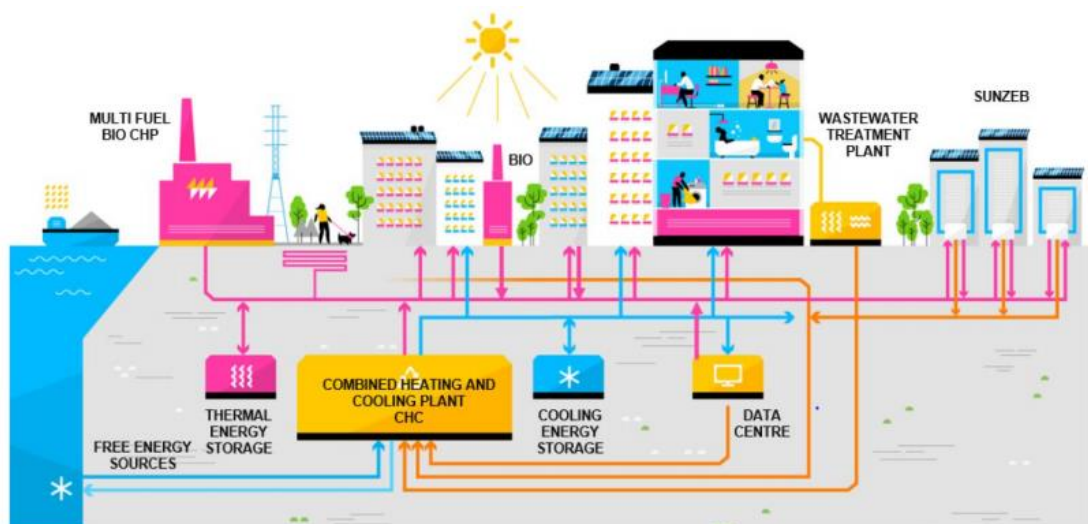



**Figure 98. Illustration of the planned area in Kalasatama, Helsinki, with the SunZEB building block indicated with an arrow (Source: City of Helsinki 2014).**

### 6.16.2 Energy Market Context

The SunZEB building is a district level integrated Nearly Zero Energy solution undertaken to maximize the use of renewables in the district heating system by using district cooling recycling in the dense city area. SunZEB buildings are integrated with the urban energy platform and they form an energy community (Figure 99). The urban energy platform acts as an enabler for the resource efficiency to harvest, convert, store, and distribute the heating, cooling, and electricity in the city of Helsinki. This platform has evolved during decades and enables diverse energy supply for city of Helsinki. The SunZEB is the latest addition to this platform. The SunZEB solution mainly focuses on the thermal energy (district heating and district cooling).



**Figure 99. SunZEB buildings are part of the urban energy platform in Helsinki operated by Helen Ltd. SunZEB together with other energy resources is connected to a combined heating and cooling plant using heat pumps between district heating and district cooling networks, converting the renewable solar energy harvested from the building.**

District heating in Helsinki is presently still mostly produced with fossil fuels with coal in CHP plants producing 53% of the energy, natural gas also in CHP plants 35%, heat pumps 8%, bio fuels 3%, and oil 1%. Converting the mix to renewable energy is a priority with the city of

Helsinki, which also owns the energy company, as it has committed to becoming carbon neutral by 2035.

Energy objectives were:

- Creating a novel solution for a Near Zero Energy Building
- Becoming an integrated part of the local energy platform and wider energy system
- Allowing the city to reduce its reliance on fossil fuels and supporting becoming carbon neutral by 2035
- Creating excellent indoor conditions for the occupants of the building.

The use of solar radiation in the SunZEB building is based on four design principles:

- The building is designed with a large enough window area to create comfortable and bright indoor conditions. The windows use a type of window with a very low U-value and a relatively high g-value (no sunscreen).
- Solar thermal load peaks are cut with properly dimensioned facade structures. Shading is primarily based on solid facade structures. When adjustable or controlled facade structures are used, the system must be functional in all circumstances.
- Overheating is prevented by a cooling system based on district cooling, which uses the solar thermal energy from a large heat pump located in the district cooling station.
- Indoor glare and overheating are further protected by user-adjustable accessories such as blinds or curtains.

In A residential SunZEB case, building solar energy accounts for 55% of the annual heat requirement. Calculations for the office building have resulted in a heat production of 157% compared to the need, which turns the building into a net producer of thermal energy over the year. In the case of the office, the result is influenced by larger window areas and lower consumption of hot water compared to residential buildings. The effectiveness of the solution in reducing CO<sub>2</sub> emissions is significant and in direct proportion to the amount of solar energy harvested. Compared with conventional construction, the SunZEB solution increases construction costs by 2%–4%, reduces energy costs by 3%–7% and increases total lifecycle costs by 1%–2%, which represents a minimal share in the total costs of the building. As a whole, the cost of the SunZEB solution is therefore low compared to the benefits of improved energy efficiency, lower carbon footprint, and more comfortable indoor conditions compared to a conventional building.

### **6.16.2.1 Electricity Supply**

The building has a conventional electricity system with high energy efficiency. In the Nordic climatic conditions the main energy consumption component and source of emissions is heating. However, the SunZEB concept (see Table 37) is compatible with the use of, for example, solar PV energy on location. Figure 100 shows the monthly energy balance calculated for the SunZEB building.

**Table 37. Information table on SunZEB project.**

The target values of the SunZEB building in measurable numbers are:	
	District heating demand < 60 kWh/m <sup>2</sup> /a
	District cooling < 20 kWh/m <sup>2</sup> /a
	Electricity < 40 kWh/m <sup>2</sup> /a
	Primary energy (national E-value) 100 - 105 kWhE/m <sup>2</sup> /a
	Indoor temperature between 21 °C (winter) to 26 °C (summer)
Additional information:	
Building mix in the area*:	14 200 m <sup>2</sup> subsidized housing, both rental and occupant owned
Consumer mix in the area**:	100% medium consumers
Energy plant owner (public or private):	Public (through city-owned company)
Insert additional information that is relevant for this project:	
Thermal energy supply technologies***:	passive solar collection, heat pump, district energy
Thermal Energy production from solar:	55% of annual heat need.
Investment costs****:	2138 €/m <sup>2</sup> compared to 2024 €/m <sup>2</sup> in conventional construction.
Lifetime costs:	2690 €/m <sup>2</sup> compared to 2598 €/m <sup>2</sup> in conventional construction.
Cooling energy used:	26 kWh/m/a

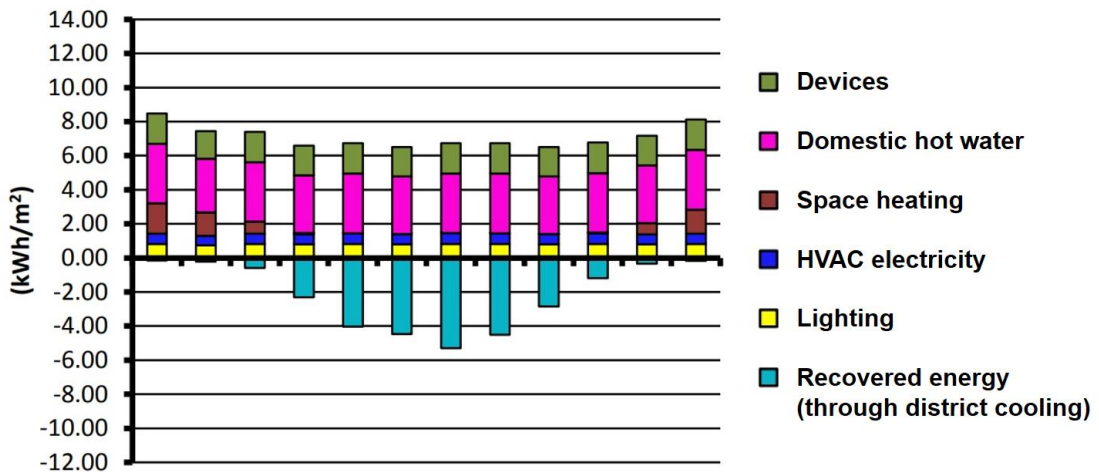

**Figure 100. Monthly energy balance calculated for the SunZEB building.**

### 6.16.3 Technical Highlight

As buildings become more energy efficient, two problems arise: district energy demand diminishes while solar heat loads grow and might require cooling. The main innovative aspect of SunZEB is that the thermal loads of a building can be seen as part of a broader energy solution, whereby the potential overheating problem becomes a usable energy resource. Thus, the whole building can be turned into a large-scale heat collector that produces energy. Benefits include that it:

- Does not require separate solar collectors, i.e., the house itself acts as an energy catcher meaning less maintenance and service needs.
- Renewable energy accounts for 55–157% of the heat need over the year and the excess energy is recovered in the grid.
- Large window surfaces improve the feeling of comfort.

- The concept includes mechanical cooling and intelligent indoor climate control for increased personal influence on comfort.
- The same life cycle cost compared to a conventional building.

Moreover, new business potential can be created: cooling can be sold as a service on the one hand and on the other hand the excess heat carried away and is sold to heat consumers.

## 6.16.4 Decision and Design Process

### 6.16.4.1 General/organizational issues

Why was this project initiated, to answer which need?

*City of Helsinki has the ambitious goal of reaching carbon neutrality by 2035 and a big part of that goal is finding alternative energy sources for the district heating and cooling network. SunZEB buildings can form an integrated renewable energy source in the urban context. Moreover, city of Helsinki has the Evolving Apartment Building Programme where innovative building concepts are sought and builders are granted benefits by the city government. Thus builders are also interested in finding and developing new innovations such as SunZEB. The main target was to reach the goal of a Near Zero Energy Building with an innovative approach and reduce GHG emissions.*

Which stakeholders were involved in the project?

- VTT Technical Research Centre of Finland Ltd. (research partner)
- Helen Ltd. (city-owned energy company)
- Finnish Energy (organization of the energy industry)
- City of Helsinki
- Ministry of Environment
- Confederation of Finnish Construction Industries RT
- Finnish Real Estate Federation
- Arkkitehtuuritoimisto Kimmo Lylykangas oy (architecture company)
- KONKRET (architecture company)
- Asuntosäätiö (real estate developer)
- Asuntosäätiön ASO-kodit Oy (real estate developer)
- Kojamo Oyj (real estate developer)
- Fira Oy (construction company).

Which resources were available before the project? What are local energy potentials?

- City development plan for the new district
- Strong participation and intervention by local administrative facilities and overall good cooperation between involved actors
- Dedicated individuals with high specific expertise
- Local solar energy potential
- Local district energy infrastructure.

Who (what) were drivers and who (what) were opponents (barriers) – and why?

*Main drivers for the project were the key stakeholders' commitment to carbon neutrality goals: the city, energy company and real estate developers. Moreover, the Evolving Apartment Building Programme of the City of Helsinki offered an attractive framework for the development especially from the real estate developer's point of view. The energy*

*infrastructure in the area, especially the connection to the large central heat pump, was a key enabler.*

*The main barrier to overcome have been the risks (perceived and real) in developing a new concept different from conventional construction practices. The developer of a pilot project often has to pay some learning costs that later projects can avoid from learning from the experiences. Another barrier is the need to efficiently organize communication with the project partners and key stakeholders.*

What have been the main challenges regarding decision finding?

*Efficient communication between the key stakeholders.*

What was finally the crucial parameter for go /no-go decision?

*Similar overall cost level compared to conventional buildings.*

#### **6.16.4.2 Financing Issues**

What have been the main challenges/constraints regarding financing?

*As the building has nearly the same cost level as a conventional building, attracting financing on a commercial basis was not a problem.*

*Which business model applies to the project?*

*The energy company (Helen) owns the equipment and sells heating and cooling as a service to the housing company managing the building. The occupants of the building pay a monthly fee.*

#### **6.16.4.3 Technical Issues**

What have been major technical challenges/constraints regarding system design?

*Optimizing the flow of solar radiation balancing between visual and thermal comfort, heating needs and optimal energy production to the network.*

What solutions have been considered for generation, storage and load management?

*In this case, the local cooling/heating network takes care of these roles. The issue becomes pertinent if there are a lot of SUNZeb buildings in a particular area. In the scale of a single building or block it is not a limiting factor.*

#### **6.16.4.4 Design Approach Applied**

Which design targets have been set and why?

*The City of Helsinki has the ambitious goal of reaching carbon neutrality by 2035 and a big part of that goal is finding alternative energy sources for the district heating and cooling network. SunZEB buildings can form an integrated renewable energy source in the urban context. Moreover, city of Helsinki has the Evolving Apartment Building Programme where innovative building concepts are sought and builders are granted benefits by the city government. Thus builders are also interested in finding and developing new innovations such as SunZEB. The main target was to reach the goal of a Near Zero Energy Building with an innovative approach and reduce GHG emissions.*

Which decision steps/workflow lead to the retained solution?

1. *The City of Helsinki has ambitious climate goals and a need to reduce fossil fuel use in the city.*

2. *This has led Helsinki's city-owned energy company Helen Ltd. to seek new innovative ways to generate energy to their district energy system.*
3. *VTT Technical Research Centre of Finland is the leading innovator in Finland with regard to new building energy systems. A project was started between VTT and Helen and other partners to create a novel approach to create a low-cost Near Zero Energy Building that is an integrated part of the local district energy network.*
4. *The concept was developed in a research project in 2014–2015.*
5. *The detailed planning of the building was done in 2017.*
6. *The construction of the building is taking place 2018–2020.*

Which tools have been used during the design phase? Include name, originate (plus web link), purpose of the tool, specific use of the tool within the case study, practical experiences during application, cost/price (if commercial tool)

*The central energy simulation tool used in the project was IDA-ICE*

What have been the main challenges in the design phase?

*To identify and bring together all necessary stakeholders and actors.*

*To ensure efficient communication between energy concept developers and architectural and technical planners of the building.*

What have been the most crucial interfaces?

*Three-way communication between the city, energy company and real estate developer.*

*Close collaboration between energy concept developers and architectural and technical planners of the building is necessary for successful results.*

What parameters are controlled via monitoring?

*Temperatures, heating, and cooling.*

### **6.16.5 Resilience**

Which threats were considered and are to be considered? Are there redundancies in the energy supply system?

*Threats: Losing the district heating or cooling service.*

*Redundancies: Passive heating can meet much more than the usual heating needs; emergency cooling can be done by ventilating to the outdoors. Natural light can also be used to meet most lighting needs.*

*The building is located at the immediate vicinity of the coastline. Helsinki city has updated its flooding strategy after a 2005 flood that momentarily covered the main market square with sea water. As a result the whole of Kalasatama area has been built high enough so that it is protected against sea level rise except in the most extreme cases.*

What is the degree of autarky?

*For heat supply, the degree of autarky is 55%. For a calculated SunZEB office case autarky degrees of over 100% have been reached but this project is yet to be realized.*

*For power supply, the degree of autarky is 0%.*

Which processes that require heat, cooling or power are there? Which ones are critical? (Order by priority). What is the possible timeout without imposing damage?

- *Emergency Lighting (critical)*

- Heating (critical in cold season)
- Cooling
- Domestic hot water
- Ventilation
- Domestic power – device shutdown after 0 seconds
- Elevator – device shutdown after 0 seconds.

Are there backup systems? On which time-scale can they be accessed?

*For heating and cooling supply, there is no backup to the district energy access. Passive heating can cover much more than usual of the heating need, emergency cooling can be done by ventilating to the outdoors. Natural light covers more than usual of lighting needs.*

*For power, there is no backup system. Future installation of PV modules and power storage would allow for autarky. This is however not necessary, due to the highly reliable local power supply.*

## **6.16.6 Lessons Learned**

### **6.16.6.1 Major Success Factors**

Tying the project to the strategic goals (carbon neutrality and others) of the city, energy company and real estate developers

Affordable solution with a similar lifetime cost compared to the conventional approach.

### **6.16.6.2 Major Bottlenecks**

District cooling with access to a heat pump that can reuse the energy is needed

If a large number of SunZEB buildings are developed, the district energy system will need to be adapted to meet the additional loads.

### **6.16.6.3 Major Lessons Learned**

Engagement of all stakeholders early on to the project is crucial to the success



Close collaboration between energy concept developers and architectural and technical planners of the building is necessary for successful results.

What should be transferred from this projects:

*In areas with district cooling access the use of buildings as solar collectors is an efficient, economical, maintenance-free way to produce large amounts of renewable energy that can have a major impact in approaching carbon neutrality*

*Collaboration between builders and the energy company can have a major impact on developing new energy solutions.*

## 6.17 Horizon 2020 Lighthouse Project mySMARTLife - Actions in Merihaka Retrofitting Area, Finland

Case No.	Country	Location	Specific Type	Photo	Special points of attention
17	Finland	Merihaka	Campus District Refurbishment		 building efficiency
<b>Country:</b>		Finland			
<b>Name of city/municipality/public community:</b>		Helsinki			
<b>Title of case study:</b>		Horizon 2020 Lighthouse project mySMARTLife - Actions in Merihaka retrofitting area			
<b>Author name(s):</b>		Esa Nykänen (VTT) Mikko Martikka (City of Helsinki, coordination of actions)			
<b>Author email(s):</b>		<a href="mailto:esa.nykanen@vtt.fi">esa.nykanen@vtt.fi</a> , <a href="mailto:mikko.martikka@hel.fi">mikko.martikka@hel.fi</a>			
<p>The Lighthouse project mySMARTLife aims at making the three Lighthouse Cities of Nantes, Hamburg and Helsinki more environmentally friendly by reducing the CO<sub>2</sub> emissions and increasing the share of renewable energy. Three Fellow Cities of Bydgoszcz (Poland), Rijeka (Croatia) and Palencia (Spain) are involved to collaborate in the project and build their sustainability agenda.</p> <p>The interventions include innovative technological solutions in connection with energy refurbishments of buildings, usage of renewable energies, clean transport and supporting ICT solutions. The project aims for transformation towards more sustainable and inclusive cities allowing improved quality of life.</p> <p>More information: <a href="https://www.mysmartlife.eu/cities/helsinki/">https://www.mysmartlife.eu/cities/helsinki/</a></p>					

### 6.17.1 Background and Framework

The City of Helsinki is doing rigorous work for climate change mitigation. The framework is embedded in the City Strategy of 2017-2021 and has been realized in the Carbon Neutral Helsinki 2035 Action Plan. One of the main topics in terms of emission reductions is to enhance the energy efficiency of the existing buildings. Merihaka, located in the Eastern inner-city area, represents a district with typical residential apartment buildings from the 1970s-1980s and such buildings are common in Helsinki (Figures 101 and 102). The area is one of the target locations for promoting energy retrofitting on district level and the pilot work is carried out in the EU Horizon 2020 Lighthouse project mySMARTLife. The project is carried out together with the Lighthouse Cities of Nantes and Hamburg as well as Fellow Cities Bydgoszcz, Palencia and Rijeka.





Figure 101. Aerial view of Merihaka area (Source: mySMARTLife/City of Helsinki).



Figure 102. Plan of Merihaka area (Source: mySMARTLife/City of Helsinki).

### 6.17.1.1 Merihaka and mySMARTLife Activities

The retrofitting work of these privately-owned apartment buildings in Merihaka was first introduced through pre-pilot experiences. This helped in creating a level of acceptance for the project actions, such as a smart heating control, heat demand response, and thermal comfort optimization study. The actions will be carried out from 2018 onwards in the project's pilot apartment building that has 167 apartments and where smart thermostats will be installed in every room. The smart heating service is connected to the city's urban platform through Internet of Things (IoT) and this allows performance evaluation and optimization with a cloud-based service by Salusfin Ltd. Other supporting measures include **Multi Objective Building Performance Optimization (MOBO)** study for hybrid solutions and

thermal imaging to pinpoint heat loss and management and optimization of the district heating and cooling system.

The project also focuses on information sharing and co-creation to achieve a larger impact. Knowledge gained through discussions and studies, for example through collaboration in district level planning, and the outcome of different incentives is shared during meetings and public events to further motivate energy efficiency measures. The city has long-term renovation of the pilot district Merihaka with 12 residential buildings as a target in the future. The first collaborative efforts by the project have inspired and drawn interest of six out of seven housing associations in the area and the planning continues with the local real estate management business. As a continuation, the measures in the project are directly linked to the implementation of the so-called Energy Renaissance program to enhance district level energy efficiency improvements as a part of the Carbon Neutral Helsinki 2035 Action Plan.

### **6.17.1.2 Energy Renaissance**

The energy renaissance program has been defined as part of mySMARTLife and it is aimed to improve the energy efficiency of buildings and to increase the share of renewable energy in the city in the long-term. The challenges identified include lack of suitable financing methods and knowledge in planning renovations and promote energy efficiency measures. Additionally, neighboring buildings' and district level collaboration can be considerably improved to reach shared targets more easily, to reduce risks, and to lower the bar for the need of individual investments.

Work in preparation has included collection of the baseline energy consumption data and estimation of the energy savings potential. VTT Technical Research Centre of Finland has performed a comprehensive technical and cost efficiency study on suggested renovation measures for particular type of apartment buildings. (The information table is embedded as a pop-up clickable feature onto the model Merihaka apartment buildings.) The City of Helsinki has also collected extensive data on buildings' energy information for open source use in the Energy and Climate Atlas as an integral part of the 3D City Model, accessible through <https://kartta.hel.fi/3d/atlas/#/>.

As one of the Merihaka activities, a study on renewable energy was performed and results discussed with the local building owners to acquire more feedback on their interests. The mySMARTLife project has also brought an energy advisor on board to assist with engagement of private stakeholders and to continue and trigger further co-creative discussions. The local energy company Helen Ltd. is also active with a business case and will be creating new business model studies as part of project actions and thus, contributing to achieve a large impact. In addition to this, measures related to the HTM and advanced smart heating control are conducted also for an office building in the Viikki Environment House, owned by the City of Helsinki Environment Services and the University of Helsinki Environmental Sciences. Similar smart heating control system as in Merihaka is provided by Fourdeg Ltd. in the case of Viikki Environment House.

The key element in smart energy transition is the focus on local renewable energy sources and decentralized energy production. The current heating system in the area is part of the citywide district heating network owned by the energy utility company Helen. The company also provides the energy grid. Helen has an ambitious development program either with the solutions already implemented or in the construction phase, such as renewable energy



The u-values of this residential building stock is already relatively good when compared to European building averages, and this can be explained by the cold climatic conditions. Thus, for replicability and impact, the project interventions focus more on the energy performance than on the building fabric (e.g., insulation of the envelope or glazing). Installation of smart controls for management of apartments' heat and electricity demand is a key intervention in the retrofitting process and the pilot approach demonstrates the solution in a building having 167 apartments. The aim is to be able to promote the uptake of retrofitting measures in the entire district. The total target area suitable for similar retrofitting measures consists of 34 buildings. The primary target for district level impact in Merihaka has 12 buildings.

Citizen engagement and involving the residents of the building are also critical to the project. Discussions with the local housing association chairpersons aim to motivate them and encourage exchange of knowledge to raise more awareness on the energy matters. Some events are open to public and some are specifically for the building owners in the form of living lab co-creation sessions. As an example, three events consist of cascading workshops with experts, residents and interested stakeholders, such as solution providers and financiers for energy retrofits. This exchange of ideas aims to match the preferences and transform retrofitting on district level. Joint discussions between the housing associations, the district real estate management company, local energy company, and the energy optimization study provider continue. The program on the city level is supported by the administration and conducted in conjunction with the City Strategy.

### **6.17.3 Highlight**

In Merihaka, smart heating control is applied with added focus of testing heat demand response to optimize energy systems and implement the human thermal comfort study with a QR code feedback system (based on the HTM developed by VTT). Together with HTM, predictive algorithms are also used to optimize energy use to achieve savings.

The MOBO study can be further used to map the best scenarios and combinations of energy conservation measures. The MOBO study for Merihaka presented interesting cases of local and hybrid energy production methods including the use of such technologies as, for example, electric boiler, seawater heat exchange, geothermal heat, and combinations of those technologies with the current district heating system. Realistic scenarios that consider all foreseen (predictable) costs on maintenance and service (energy pricing), based on current cost structure, may be used to propose possibilities to considerable savings and emission reductions. Best case studies show energy use reduction in the scale of 33kWh/m<sup>3</sup>/a, and savings on life cycle costs by 2.9MEur over a period of 25 years. Investment costs compared to BAU scenario are 1.2MEur higher yet at the same time CO<sub>2</sub> emissions are reduced by 730tCO<sub>2</sub>/a.

Helen uses multiple sources in its energy profile including coal, natural gas, nuclear, hydro, solar, wind, wood pellets, biogas, and fuel oil when necessary as well as excess and waste heat collected from household heat recovery systems, data centers, seasonal storages and sea water heat exchangers (Figure 104). Energy systems development are being developed also with options in decentralized energy production systems and increasing the share of renewable energy sources.

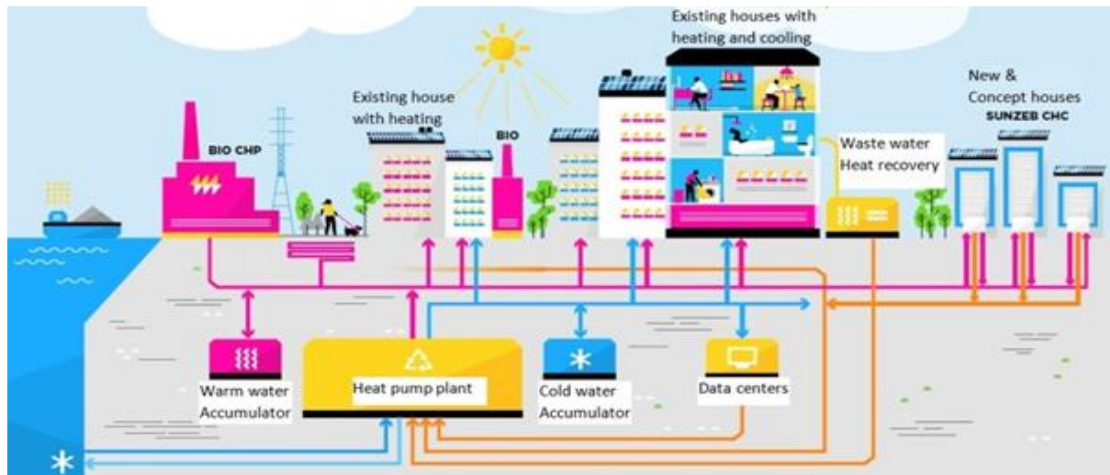

Figure 104. Merihaka Energy System (Source: Helen).

## 6.17.4 Decision and Design Process

### 6.17.4.1 General/Organizational Issues

Why was this project initiated, to answer which need?

*Buildings requiring refurbishment, phasing out of the coal power plant (heat sources?), Carbon Strategy for Helsinki*

Which stakeholders were involved in the project?

*Energy utility companies, residents, building owners, municipality*

Which resources were available before the project? What are local energy potentials? Who (what) were drivers and who (what) were opponents (barriers) – and why? What have been the main challenges regarding decision finding? What was finally the crucial parameter for go /no-go decision?

*The project mySMARTLife takes Carbon Neutral Helsinki 2035 Action Plan pilots into practice. The framework is supported by the City Strategic Objectives for a carbon neutral future. The main stakeholders in the process together with the city's climate experts, the innovation unit, and climate specialists network also include the local energy utility company, research and innovation development institutes, and SME's and start-ups on buildings energy efficiency. Comprehensive local participation work has been a standard for Helsinki for quite some time already and for mySMARTLife this covers several company contacts, target area residents, building owners, real estate management sector, and solution providers as well as the citizens as a whole in other areas, and urban transformation objectives.*

*Large-scale and district-wide energy efficiency improvements or "Energy Renaissance" is one of the main targets for the city and is a major driver as a tool to bring the stakeholders together and for the city to facilitate the improvements and provide the platforms to get buildings owners and renovation providers to interact.*

*Challenges lie in finding the correct motivators and sufficient resources and perspectives in active facilitation work on energy improvements. Initial drivers often vary and they may not arise primarily from a climate consideration or perspective, but from individual needs; they will require easy, practical solutions for daily use.*

#### **6.17.4.2 Technical Issues**

What have been major technical challenges/constraints regarding system design?

*Technical implementation has not been a considerable challenge but lack of cohesion and common vision towards same main objectives needs constant revising to streamline the process. This is also a clear target that will be improved through the Energy Renaissance program and commitments to the main objectives and project collaborations.*

What solutions have been considered for generation, storage, and load management?

#### **6.17.4.3 Design Approach Applied**

Which design targets have been set and why? Which decision steps/workflow lead to the retained solution?

*Individual building-level energy efficiency and district level system design use an integrated approach covering known and feasible solutions in system optimization possibilities. Current heating system is provided by the highly efficient district heating system extending almost throughout the city (94% coverage). Improvement steps have specific starting level values on energy efficiency (u-values, etc.) and spectrum of solutions and scheduling needs to be considered appropriately due to upcoming district developments. The current system is very efficient but it could be improved considering centralized/decentralized production and availability of renewables.*

Which tools have been used during the design phase? Include name, originate (plus web link), purpose of the tool, specific use of the tool within the case study, practical experiences during application, cost/price (if commercial tool)

*What have been the main challenges in the design phase?*

*FOR ENERGY RENAISSANCE and mySMARTLife Merihaka Actions: Commercial and private tools such as IDA-ICE and MOBO have been used for climate and energy and system calculations and scenarios.*

#### **6.17.5 Resilience**

Which threats were considered and are to be considered? Are there redundancies in the energy supply system?

*Relevant parts to discuss here for our pilot case study or linkages in project: H2020 EU project Stardust e.g., Tampere Energy Company and Enermix solutions on retrofitting of smart heating control*

What is the degree of autarky?

*Low/mediocre at start, possibility of considerable increase in self-sufficiency.*

Which processes that require heat, cooling or power are there? Which ones are critical? (Order by priority). What is the possible timeout without imposing damage?

*Large residential buildings require heating (cooling, pumping, lighting, other household electricity, parking facilities). There is a need for the technical possibility to provide businesses in the area with electricity (convenience store, sports arena, restaurants).*

## 6.17.6 Lessons Learned

### 6.17.6.1 Major Success Factors

The first pilots (at least in Viikki) already show savings. Numerous possibilities in implementation and viable hybrid solutions for all stakeholders.

### 6.17.6.2 Major Bottlenecks

Motivation – there are small to mediocre financial benefits with one smart heating control solution only without apartment/user-based billing.



### 6.17.6.3 Major lessons learned

Inclusiveness, shared decision making boosting local participation, knowledge transfer, networks of best practice solutions and their providers, match-making and district level learnings for early planning.

What should be transferred from this project

*Flexibility of consortiums/individual partnerships by the local needs, and working towards common goals. Improvement needed on methods of integrated approach on large-scale improvements.*

## 6.18 Underground District Heating and Cooling Plant Located in Esplanade Uses Waste Heat; Helsinki, Finland

Case No.	Country	Location	Specific Type	Photo	Special points of attention
18	Finland	Helsinki Esplanadi Park	Single Component Heat pump for district heat		 <p>heat pump for district heating/cooling</p>
<b>Country:</b> Finland <b>Name of city/municipality/public community:</b> Helsinki <b>Title of case study:</b> Underground District Heating and Cooling Plant located in Esplanade Uses Waste Heat <b>Author name(s):</b> Francesco Reda, Zarrin Fatima <b>Author email(s):</b> <a href="mailto:Francesco.reda@vtt.fi">Francesco.reda@vtt.fi</a> , <a href="mailto:Zarrin.fatima@vtt.fi">Zarrin.fatima@vtt.fi</a> <b>Link(s) to further project related information/publications, etc.:</b> <a href="https://www.helen.fi/en/news/2017/large-heat-pumps-arrive-in-helsinki/">https://www.helen.fi/en/news/2017/large-heat-pumps-arrive-in-helsinki/</a>					

### 6.18.1 Background and Framework

Helsinki has formulated its Carbon Neutral strategy for 2035. A Helsinki expert group has completed a proposal for an action plan that outlines how the city can be rendered carbon neutral by 2035. The plan provides details regarding how to minimize energy consumption and increase onsite renewable energy generation in the city. The plan will be implemented side by side with a program to render the city's centralized energy production carbon neutral (City of Helsinki 2018).

Helsinki's description of carbon neutrality is to decrease GHG emissions produced within the city borders by 80% and to offset the rest. The biggest emitter of GHGs is heating. Based on the action plan, the city can reduce emissions by upgrading old building stock, stricter standards for construction, heat recovery and geothermal heating (City of Helsinki 2018).

Helen, the city-owned energy company, has already made plans to become carbon neutral by 2035. Today, Helen uses combined district heat and power (CHP) to heat 90% of the buildings in Helsinki. The process is half fueled by coal and one-third by natural gas. Helen aims to raise renewable energy use from 10% to 70% and replace fossil goals by using waste heat through heat pumps (City of Helsinki 2018).

Helen has inaugurated a new heating and cooling plant (Figure 105) under the Esplanade Park at a depth of some 50 m. The pumps operate on the principle of capturing waste heat from buildings. The construction began in spring 2017 and the plant will begin operating in spring 2018 (Kaartokaallio 2018, Helen Co. 2018c). Finland's largest district cooling water reserve is located under the Esplanade Park in the rock cavern at a depth of about 100 m. The cooling reserve holds 25 million liters of water, corresponding to the volume of an average-sized lake (Helen Co. 2018d) and receives water from the lakes and sea (Peters 2014). The heat pumps operate together with the cooling accumulator; together they form the underground Esplanade cooling center to improve heat recovery from properties even further and use the heat in district heating (Helen Co. 2018d,e). However, the first cooling reservoir had already been built in Pasila in 2012 with a capacity of 11 million liters (Helen Co. 2018f). The Esplanade heat pumps will meet the growing need for district cooling in Helsinki (Galkin-Aalto 2017).

The two newly completed heat pumps that produce heat and cooling are large entities with their pipework. The heat pumps enhance the cooling output of the entire plant to 50MW and this is equivalent to meeting the cooling need of the Parliament House 35 times over. In parallel, the pumps are able to replace Helen's use of fossil fuels for energy provision and thus, carbon emissions are reduced by more than 20,000 tonnes a year (Table 38) (Helen Co. 2018e).





**Figure 105. New heating and cooling plant located under Esplanade Park at a depth of 50metres (Source: Helen).**

**Table 38. Quantitative Information of the heat pump project in Esplanade Park.**

<b>Esplanade heating and cooling plant Sources: Kaartokaallio (2018), Galkin-Aalto (2017)</b>	
Heat pump power	2 x 11 MW of heat 2 x 7.5 MW of cooling
Reduction in CO <sub>2</sub> emissions	20 000 tonnes
Total investment in heat pumps	EUR 10 million
Cooling output	New heat pumps 15 MW + existing cooling water reserve 35 MW = 50MW
Current project situation	New heat pumps inaugurated in summer 2018 Water reservoir in operation since 2015

### 6.18.2 Technical Highlight and Motivation

Energy storage is a critical part of a smart energy system as it enables flexible use of energy in various demand situations. The district cooling system in Helsinki is claimed to be the third largest in Europe. Helsinki reached record high levels of cooling demand in summer 2018 where the demand jumped from an average of 30-40 MW per day to 114 MW per day (Helen Co. 2018d, Galkin-Aalto 2013, Uusitalo 2015). The cooling storages (Figure 106) receive cooled water from the surrounding sea and lakes and as the demand for cooling increases the next day, the water circulates in the buildings and removes the waste heat and maintains comfort. At night, the water returns back underground to become cool again.



Why was this project initiated, to answer which need?

*The need for district cooling is on the rise. Helsinki reached its record high demand in the summer of 2018. The possibility to store cooling energy helps avoid day-to-day fluctuations in the cooling demand.*



Figure 106. Underground water cooling reservoir in Esplanade Park located at a depth of 100m (Photo by Pekka Nieminen from Helen cited in an article by Walker, <https://gizmodo.com/helsinki-built-an-underground-lake-to-cool-its-building-1631985837>).

## 6.19 Katri Vala – A Mega Heating and Cooling Plant; Helsinki, Finland

Case No.	Country	Location	Specific Type	Photo	Special points of attention
19	Finland	Helsinki Katri Vala	Single Component Heat pump for district		  heat pump for district heating/cooling
<b>Country:</b> Finland <b>Name of city/municipality/public community:</b> Helsinki <b>Title of case study:</b> Katri Vala - a mega heating and cooling plant <b>Author name(s):</b> Francesco Reda, Zarrin Fatima <b>Author email(s):</b> <a href="mailto:Francesco.reda@vtt.fi">Francesco.reda@vtt.fi</a> , <a href="mailto:Zarrin.fatima@vtt.fi">Zarrin.fatima@vtt.fi</a> <b>Link(s) to further project related information/publications, etc.:</b> <a href="https://www.helen.fi/en/company/energy/energy-production/power-plants/katri-vala-heating-and-cooling-plant/">https://www.helen.fi/en/company/energy/energy-production/power-plants/katri-vala-heating-and-cooling-plant/</a> <a href="https://www.youtube.com/watch?v=iVgOLyeEK90">https://www.youtube.com/watch?v=iVgOLyeEK90</a>					

### 6.19.1 Background and Framework

Katri Vala is the largest heat pump plant in the world to produce district heat and cooling (Figures 107 and 108). Its carbon dioxide emissions are 80% smaller than for example in separate heat production with heavy fuel oil (Helen Co. Undated). The plant is located in the

Sörnäinen district of Helsinki and inside a rock cavern located under the well-known Katri Vala park. The facility is an example of super-efficient recycling of energy (Kotilainen 2015).



Figure 107. Katri Vala facility (Source: Helen).

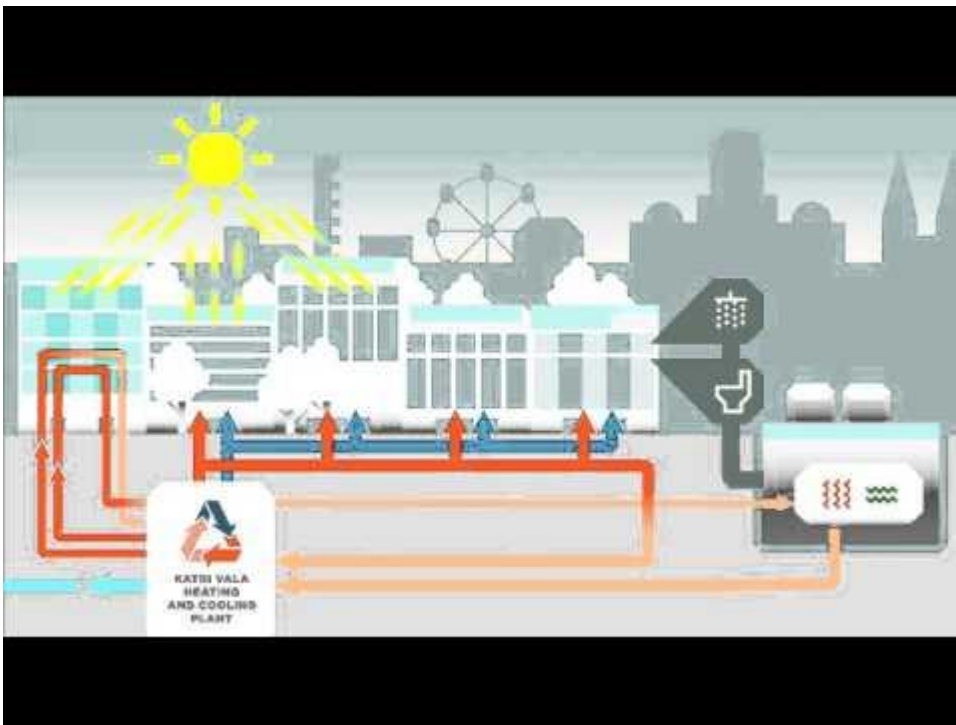

Figure 108. Katri Vala operation (Source: Helen).

A great deal of energy is wasted in traditional methods of cooling buildings. The cooling machinery of properties consumes a lot of electricity, but the heat recovered from the facilities is removed by directing it into the open air. The operating principle of the Katri Vala heating and cooling plant is different. The plant combines and recycles different kinds of energy flows from the city, which means that waste energy from one location is taken advantage of elsewhere. The most important task of the plant is to produce district cooling for offices, homes and, for example, data centers in Helsinki. The cooling water cools down and the heating water heats up in the same process, and hardly anything goes to waste. The second cycle is related to wastewater. Purified water is directed to the plant from the Viikki

wastewater treatment plant. The waste heat of the Viikki plant is also conducted into the district heating network (Kotilainen 2015).

The heat pump operates on the same principle as a refrigerator. In the Katri Vala plant, heat pumps transmit energy away from the return water of district cooling (about 16–18 °C), cooling it down to about 4 °C. Energy is transmitted to the other side of the pump where the return water of the district heating network (about 45 °C) is again heated up to 88 °C. The Katri Vala plant has five of these large heat pumps, each in its own ‘cave’. Purified wastewater from Viikki is directed into the heat exchangers at a temperature of 10–20 °C, and the heat of this water is recovered. Approximately 260,000 m<sup>3</sup> of water flows through the heat exchangers every 24-hours (Kotilainen 2015).

The plant was completed in 2006. The production output of the plant is 90 MW of district heat output and 60 MW of cooling output (City of Helsinki 2014). This is sufficient for meeting the heating needs of a small Finnish town and cooling needs of 100 large commercial buildings.

For 10 years now, Katri Vala’s heating and cooling plant has been an essential part of Helen’s heat and cooling production. In 2016, the plant reached a new production record and already produced 7% of the district heat in Helsinki (Kestävä Energia Talous 2017) and in 2017, the plant produced more heat than ever before, a total of 570,000 MWh (Helen Co. 2018).

Helen, the city’s energy company, is planning investments for a new heat pump to increase the plant’s production volume by as much as 200,000 MWh, i.e., by almost 30% (see Table 39). With the new pump, heat will be recovered from the heat of wastewater that has already been used, which will significantly improve the efficiency of recycling thermal energy. Moreover, this will substantially reduce the thermal load ending up in the Baltic Sea along with wastewater. The investment will reduce Helen’s carbon dioxide emissions by about 65,000 tonnes per year (Helen Co. 2018).

**Table 39. Quantitative information on Katri Vala heat pump in Helsinki, Finland.**

<b>Katri Vala</b>	
Year completed	2006
District cooling capacity	60MW
District heating capacity	90MW
New heat pump capacity	12MW - district cooling 18MW - district heating
Increase in heat recovery	130 000MW
Investment cost of sixth heat pump	EUR 20 million
New heat pump to be completed by	2021

### 6.19.2 Highlight and Motivation

A high volume of purified wastewater, the heat of which is used in district heat production, flows in the wastewater outfall tunnel 24-hours a day. In winter, heat energy is obtained with heat pumps from purified wastewater, which is led from the Viikinmäki central wastewater treatment plant to the sea (City of Helsinki 2014).

In summer, heat energy is recovered from the return water in district cooling, in which case the heat pumps produce both district heat and district cooling. If all of the heat produced in

the summer season is not needed, the extra heat can be expelled into the sea (City of Helsinki 2014). District cooling is also produced with the absorption cooling technology and, in the winter, with sea water. Production and demand response are balanced with gigantic cooling water reserves located under the Esplanade Park and in the district of Pasila. Waste energy recovered with district cooling is processed in the heat pump plant to be used further as district heat. In the summer, district heat is used for producing hot tap water for properties (Kotilainen 2015).

Why was this project initiated, to answer which need?

*Katri Vala plays a vital role in reducing the city's emissions and use of fossil fuels. CHP and District Heating (DH) have long been the basis of Helsinki's energy supply – without this system, emissions would be much higher in the city. Energy consumption in heating is a critical part of the Helsinki's struggle with CO<sub>2</sub> emissions. Of Helsinki's consumption-based GHG emissions, 44% comes from heating, 30% from the use of electricity and 20% from traffic. In 1998, trials with District Cooling (DC) systems began and by 2001 they were permanently introduced to the city. The production of DC is based on renewable and other energy sources otherwise wasted (C40 Cities 2011).*

## 6.20 Finland's Largest Heat Storage Facility to Be Constructed in Old Oil Caverns in Mustikkamaa Area Located in Helsinki, Finland

Case No.	Country	Location	Specific Type	Photo	Special points of attention
20	Finland	Helsinki Mustikkamaan	Single Component Heat storage for district	<p>The diagram illustrates the energy flow for the Mustikkamaan Lämpövarasto. It shows a power plant (ENERGIAVERKKO) connected to a district heating network. The network includes a heat exchanger (Lämpösiivittäjä) and two large storage caverns (LÄMPÖVARASTO) containing water. The caverns are connected to a network of pipes (300 m diameter) that deliver heat to buildings. The diagram also shows a cross-section of the caverns and the surrounding rock structure.</p>	<p>thermal storage, district heating</p>
<b>Country:</b> <b>Name of city/municipality/public community:</b> <b>Title of case study:</b> <b>Author name(s):</b> <b>Author email(s):</b> <b>Link(s) to further project related information/publications, etc.:</b>				Finland Helsinki Finland's largest heat storage facility to be constructed in old oil caverns in Mustikkamaa area located in Helsinki Francesco Reda, Zarrin Fatima <a href="mailto:Francesco.reda@vtt.fi">Francesco.reda@vtt.fi</a> , <a href="mailto:Zarrin.fatima@vtt.fi">Zarrin.fatima@vtt.fi</a> <a href="https://www.helen.fi/en/news/2018/Gigantic-cavern-heat-storage-facility-to-be-implemented-in-Mustikkamaa/">https://www.helen.fi/en/news/2018/Gigantic-cavern-heat-storage-facility-to-be-implemented-in-Mustikkamaa/</a> <a href="https://www.helen.fi/en/news/2017/rock-cavern-heat-storage-planned-for-Helsinki/">https://www.helen.fi/en/news/2017/rock-cavern-heat-storage-planned-for-Helsinki/</a>	

### 6.20.1 Background and Framework

The Finnish Government has submitted a legislative proposal to Parliament to ban the use of coal in energy production. According to the proposal, use of coal in energy production will cease in the 2020s (Uusitalo 2018).

Helen, the city's energy utility company, has already begun to replace coal in energy production by closing its coal-fired power plant in Hanasaari (western Helsinki) region by

2024. Due to the closure of the coal power plant, heat production will drop by 400MW. As a result, Helen’s capacity in district heat and electricity generation will fall by 870MW and 380MW, respectively. Alternative sources of heat and electricity are already in operation, such as a new pellet-fired heating plant in Salmisaari. However, Helen has further plans to meet the heat demand of the city (Uusitalo 2018).

One of Helen new plans includes construction of Finland’s largest rock cavern heat storage in Mustikkamaa Helsinki (see Figures 109 and 110, and Table 40). Three large oil caverns are located underground in Mustikkamaa and were previously used for storing heavy fuel oil. The oil storage facilities were decommissioned and vacated in 1999. Two of the rock caverns are identical and have the possibility to be used for heat storage. The volume of the storage facility would be about 260,000m<sup>3</sup>. The planned rock cavern heat storage facility is 10 times as large as Helen’s facility in Vuosaari and it would raise the optimization of Helen’s energy production to a new level. The possibility to store heat, in general, is to balance the daily consumption peaks. On the coldest winter days, the start-up of separate natural gas and oil-fired heating plants can be avoided by using the storage facility. The charging and discharging capacity of the heat storage is 120MW, i.e., the operating time is 4 days with full charging/discharging. In addition, the storage facility would accommodate over 40 times as much hot water as the amount of water in the pools at the Helsinki Swimming Stadium (Uusitalo 2018, Helen 2018).

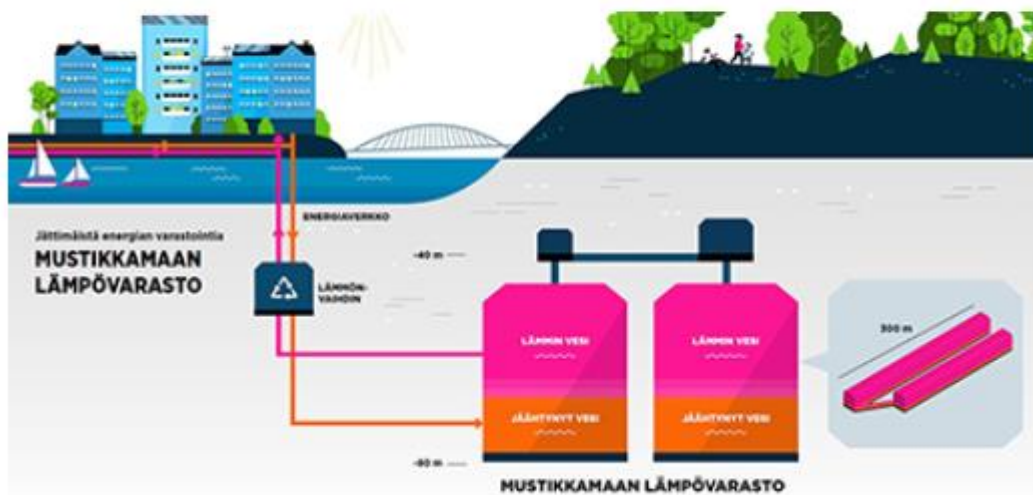

Figure 109. Mustikkamaa planned seasonal storage (Source: <https://www.helen.fi/en/news/2018/Gigantic-cavern-heat-storage-facility-to-be-implemented-in-Mustikkamaa/>).



**Figure 110. Underground facility** (Source: <https://www.helen.fi/en/news/2018/Construction-of-rock-cavern-heat-storage-facility-starts/>).

Helen is committed to climate-neutral energy production and by 2025 it aims to reduce CO<sub>2</sub> emissions by 40% compared to 1990 levels, enhance use of renewable energy by 25%, and halve the use of coal. Helen is already investing a total of some half a billion euros in low-emission energy production in the next few years (Uusitalo 2018). Regarding future plans, Helen plans to stimulate use of bioenergy, heat pumps, and energy storages as coal is phased out (Tsvetomira 2018).

**Table 40. Quantitative Information on Mustikkamaa.**

<b>Mustikkamaa (Sources: Galkin-Aalto 2018, Arponen 20180</b>	
Volume	260000 m <sup>3</sup>
Type of energy stored	District heating
Operating temperature	45 - 100 °C
Total energy stored	Energy content: 11.6 GWh Approximately 140 GWh annual production (corresponding to 25000 one-bedroom apartments)
Charging and discharging capacity	120 MW - sufficient for 4 days
Reduction of CO <sub>2</sub> emissions	21000 tonnes
Reduction in use of fossil fuels	1 000 000 liters of oil per year
Current project situation	Construction to start in early 2019 and to be completed by 2021
Investment value	EUR 15 million (EUR 2.1 million granted by Ministry of Economic Affairs and Employment)

### 6.20.2 Technical Highlight and Motivation

With the construction of the Mustikkamaa storage facility, it will no longer be necessary to use and produce district heat consumed in Helsinki all at the same time (Galkin-Aalto 2018).

Heat or surplus heat produced with a high-efficiency rate will be stored in the facility when the heating need in Helsinki is not at its highest. The heat can be used throughout the year.

During the winter time, it may help avoid starting up heating plants that operate on oil or gas, thus Mustikkamaa greatly reduces the dependency on fossil fuels (Galkin-Aalto 2018).

The heat storage facility will provide flexibility to the energy system as it will balance variable heating demand through charging and discharging. When discharging the storage facility, the heat can be used as such in the form of district heat (Galkin-Aalto 2018).



The water in the heat storage facility is not connected to the water in the district heating network. Heat is transferred from the water in the facility into the water in the district heating network by means of heat exchangers. It takes 4 days to fill the heat storage facility with heat, and it can be discharged in full in 4 days (Galkin-Aalto 2018).

The Mustikkamaa heat storage facility will allow to improve the energy efficiency of the energy system. It can be used to enhance operating time in combined heat and power generation and improve its possibilities of operating in the future, thus safeguarding the security of energy production and supply (Galkin-Aalto 2018).

Why was this project initiated, to answer which need?

*To mitigate climate change and optimize energy production. Finland will phase out use of coal in energy production in the 2020s and Helen has already planned to fill the gap in energy production through energy storages and switching to bioenergy and heat pumps.*

## 6.21 World's First and Largest Seasonal Storage in Old Rock Caverns: Kruunuvuori, Finland

Case No.	Country	Location	Specific Type	Photo	Special points of attention
21	Finland	Helsinki Kruunuvuori	Single Component Seasonal heat storage for district		 seasonal thermal storage for district heating
<b>Country:</b>		Finland			
<b>Name of city/municipality/public community:</b>		Kruunuvuori			
<b>Title of case study:</b>		World's first and largest seasonal storage in old rock caverns: Kruunuvuori, Finland			
<b>Author name(s):</b>		Francesco Reda, Zarrin Fatima			
<b>Author email(s):</b>		<a href="mailto:Francesco.reda@vtt.fi">Francesco.reda@vtt.fi</a> , <a href="mailto:Zarrin.fatima@vtt.fi">Zarrin.fatima@vtt.fi</a> ;			
<b>Link(s) to further project related information/publications, etc.:</b>		<a href="https://www.helen.fi/en/news/2018/Seasonal-energy-storage-facility-is-planned-for-the-Kruunuvuorenranta-rock-caverns/">https://www.helen.fi/en/news/2018/Seasonal-energy-storage-facility-is-planned-for-the-Kruunuvuorenranta-rock-caverns/</a>			

### 6.21.1 Background and Framework

The Finnish Government has submitted a legislative proposal to Parliament to ban the use of coal in energy production. According to the proposal, use of coal in energy production will be stopped during the 2020s (Uusitalo 2018).



Helen, the city’s energy utility company, has already begun to replace coal in energy production by closing its coal-fired power plant in Hanasaari (western Helsinki) region by 2024. Due to the closure of the coal power plant, heat production will drop by 400MW. As a result, Helen’s capacity in district heat and electricity generation will fall by 870MW and 380MW respectively. Alternative sources of heat and electricity are already in operation, such as a new pellet-fired heating plant in Salmisaari. However, Helen has further plans to meet the heat demand of the city (Uusitalo 2018).

Helen and Skanska are investigating the possibility of constructing a massive seasonal heat storage facility in the old rock caverns located beneath Kruunuvuori in Helsinki. There are reportedly no other similar solutions existing anywhere else in the world. The seasonal energy storage is part of an energy system that will use sea water heated by the sun and the recycled heat of the residential buildings. The caverns located beneath Kruunuvuori have previously been used as an oil stockpile. The total capacity of the caverns is 300 000m<sup>3</sup> and they are located 50metres below sea level (Jääskeläinen 2018).

The solution designed by Helen is based on an energy model that uses heat pumps for heating and cooling of buildings. In the summer, the caverns will be filled with surface water heated by the sun and collected from Kruunuvuorenselkä, and in the winter this water is used as the energy source for heat pumps. During the summer, surplus solar heat from buildings is also collected and recycled to be used by the residents. Hence, in the model, the sea water and the buildings heated by the sun will act as an energy source for the heat pumps, and from here the heat can be distributed into the heating networks (Jääskeläinen 2018).

The capacity of the planned seasonal energy storage facility will meet as much as one-third of the heating energy need of the entire Kruunuvuori district. In Helsinki, heat demand during winter season is 10 times larger than in the summer season. In the planned solution, water in the open sea area of Kruunuvuori heated in the summer will be stored in gigantic rock caverns, and in the winter season the heat of the sea water is used as a source of heat (Jääskeläinen 2018, also see Table 41).

Helen is committed to climate-neutral energy production and by 2025 it aims to reduce CO<sub>2</sub> emissions by 40% compared to 1990 levels, enhance use of renewable energy by 25% and halve the use of coal. Helen is already investing a total of some half a billion euros in low-emission energy production in the next few years (Uusitalo 2018). Regarding future plans, Helen plans to stimulate use of bioenergy, heat pumps, and energy storage as coal is phased out (Tsvetomira 2018).

**Table 41. Quantitative Information on heat storage at Kruunuvuori, Finland.**

<b>Kruunuvuori seasonal storage (Source: Arponen 2018)</b>	
Volume	300 000m <sup>3</sup>
Type of energy stored	Seawater heat
Operating temperature	2 - 24 °C
Annual production	About 6 - 7 GWh
Charging/discharge capacity	3MW
Current project situation	Feasibility study ongoing

The caverns (see Figure 111) were built and maintained by the oil company Shell and they were built in the early 1970s. Shell used parts of the caverns as its diesel oil stores, and the

rest of the caverns were used as a stockpile for the oil products of the National Emergency Supply Agency, operated by Shell. Skanska took ownership of the caverns in 2014.

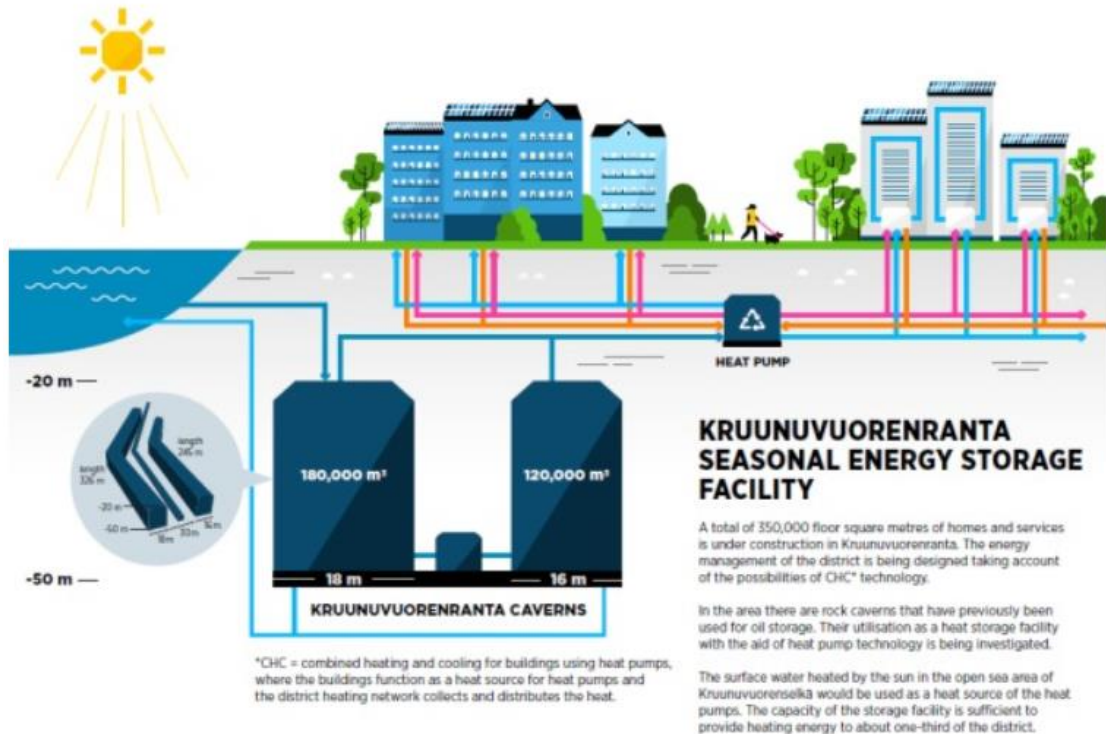

Figure 111. Seasonal energy storage in Kruunuvuori (Source: <https://www.helen.fi/en/news/2018/Seasonal-energy-storage-facility-is-planned-for-the-Kruunuvuorenranta-rock-caverns/>).



### 6.21.2 Technical highlight and motivation

Kruunuvuori has two caverns: one is about 16 m wide and the other about 18 m wide. The height of the caverns is about 30 m. The length of the larger cavern is 326 m and that of the smaller one is 245 m. The bottom of the caverns is 50 m below the sea level. The total volume of 300,000m<sup>3</sup>, or 300 million liters, corresponds to the size of about three Parliament Houses (Jääskeläinen 2018).

Why was this project initiated, to answer which need?

*To mitigate climate change and optimize energy production. Finland will phase out use of coal in energy production in the 2020s and Helen has already planned to fill the gap in energy production through energy storages and switching to bioenergy and heat pumps.*

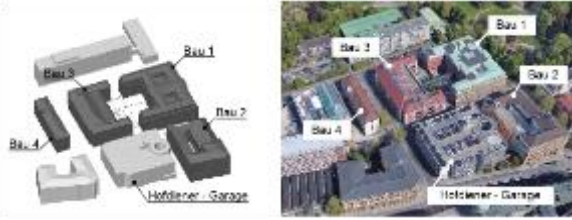
## 6.22 University Campus in Stuttgart, Germany

Case No.	Country	Location	Specific Type	Photo	Special points of attention
22	Germany	Stuttgart	Campus University		 solar energy, building efficiency
<b>Country:</b>		Germany			
<b>Name of city/municipality/public community:</b>		Stuttgart			
<b>Title of case study:</b>		EnSign – Reallabor Campus/HFT Stuttgart			
<b>Author name(s):</b>		Verena Weiler, Sally Köhler, Jonas L. Stave			
<b>Author email(s):</b>		<a href="mailto:verena.weiler@hft-stuttgart.de">verena.weiler@hft-stuttgart.de</a> , <a href="mailto:sally.koehler@hft-stuttgart.de">sally.koehler@hft-stuttgart.de</a> , <a href="mailto:jonas.stave@hft-stuttgart.de">jonas.stave@hft-stuttgart.de</a>			
<b>Link(s) to further project related information/publications, etc.:</b>		<a href="https://www.hft-stuttgart.de/forschung/projekte/abgeschlossen/ensign">https://www.hft-stuttgart.de/forschung/projekte/abgeschlossen/ensign</a> <a href="https://www.hft-stuttgart.de/forschung/projekte/abgeschlossen/um-projekt">https://www.hft-stuttgart.de/forschung/projekte/abgeschlossen/um-projekt</a>			

### 6.22.1 Background and Framework

The lighthouse project EnSign, a climate-neutral inner-city campus, was conducted at the HFT Stuttgart, University for Applied Sciences, which was established in 1832. Currently ca. 4,000 students are taught by 130 professors focusing especially on areas concerning building physics, civil engineering, architecture and design as well as computer sciences, mathematics, geoinformatics, and business management.

The campus, located in downtown Stuttgart (Figures 112 and 113), mainly consists of four old buildings (*years 1870-2000*), with a total heated area of 28,850 m<sup>2</sup> and a new building that was just finished in 2017 (*heated area 5,900 m<sup>2</sup>*).

As can be seen in Figure 114, those buildings show wide variations in the building energy standard.

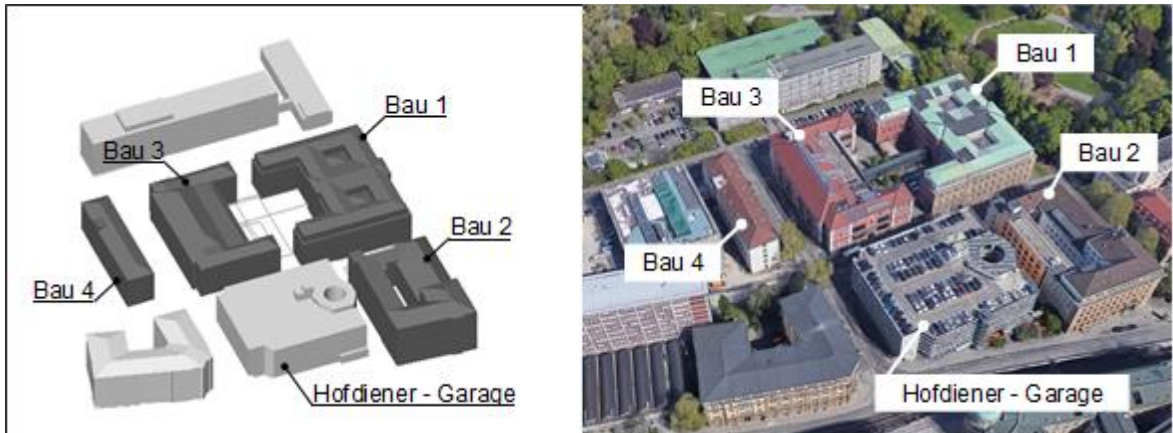
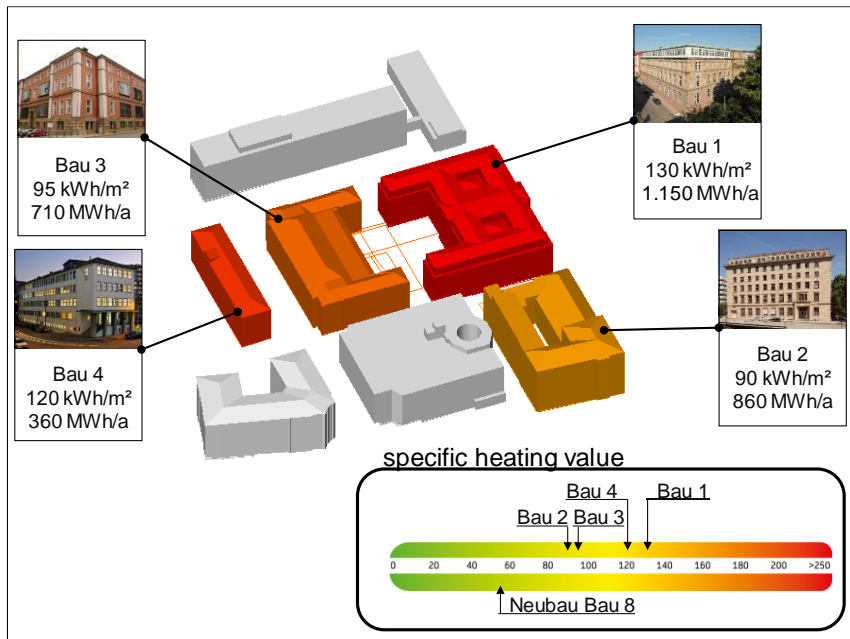

Figure 112. 3D-Model of the HFT Campus buildings and overview of the neighborhood (Source: left, EnSign Reallabor HFT Stuttgart; right, google maps 2018).



Figure 113. Concept of energy demand and distribution and refurbishment potentials in the Campus neighborhood (Source: Handlungsleitfaden – Energieleitplan | ZNS HFT Stuttgart).



**Figure 114. Heating Energy consumption statistics of the HFT Campus (Source: EnSign Reallabor HFT Stuttgart).**

Since the specific heating value and other building performance indicators show the need for improvement for most of the campus buildings, the EnSign Reallabor Project was established, with the goal of achieving a climate-neutral campus in combination with testing the research approach “Reallabor” for the first time at HFT; this involves many stakeholders: all faculty at HFT, students, neighbors, public administration, etc.

### 6.22.2 Energy Market Context

The federal state of Baden-Württemberg is owner and operator of the HFT Campus. Therefore, no direct incentives have been implemented to encourage users to save energy. The overall heating consumption in 2016 was 3,500 MWh/a, and the electric consumption 1,900 MWh/a.

District heating is available in many areas of Stuttgart including the area of the campus. The main heat source of the district heating system is waste heat from coal and waste-to-energy plants, setting the primary energy factor at  $f_p = 0.55$ , the  $CO_2$ -factor at  $162 \text{ g } CO_2/kWh$  and the price at  $0.085 \text{ €/kWh}$ . In the future, more gas-fired power plants will be connected to the heating grid improving the primary energy factor.

All federal buildings of the state of Baden-Württemberg (including all universities such as the HFT) are supplied with green electricity ( $f_p = 0.19$  |  $50 \text{ g } CO_2/kWh$  |  $0.1845 \text{ €/kWh}$ ). (Comp. electrical energy mix in Germany 2016:  $f_p = 1.80$  |  $476 \text{ g } CO_2/kWh$ )

The energy cost for 2016 for the above-mentioned buildings add up to  $646,000 \text{ €/a}$ .

### 6.22.3 Energy Objectives

There are several guidelines and state-imposed regulations with different energy objectives regarding this project, for example:

- 90% reduction of  $CO_2$  emissions by 2050 (<-> 1990)

- Climate-neutral state government (including university buildings) by 2040.

Therefore, the vision for the lighthouse project of a climate-neutral campus by 2030 was developed.





Due to the fact that standard refurbishment scenarios are not applicable because there is a need to preserve the architectural value and integrity of the building assembly (per preservation orders), this project focuses on local (decentral) and independent energy production. That implies several possibilities e.g., a combination of electricity generation with PV and a heating system with either:

- CHP + gas boiler or a link to the heating network
- heat pump (wastewater) + link to the heating network
- CHP + heat pump (wastewater) + gas boiler or a link to the heating network.

An interface between the local heating network and the existing district heating network would be also a valuable idea for the implementation.

As concrete measures to improve the energy balance of the HFT Campus, the following options (Table 42) were examined:

**Table 42. List of measures for HFT Campus Stuttgart**

	Measure	Scenario	Description
	<b>Lighting</b> Bau 1 - 4	LED installation	Replacement of fluorescent tubes with LED (3.900 lights) – power reduction 65 %
		Light control	Installation of light and motion sensors in all hallways
	<b>Heating</b> Bau 1 - 4	Radiator valves	Installation of digital radiator valves in all lecture rooms
		Circulating pumps	Replacement with high efficiency circulating pumps
	<b>Photovoltaics</b> Bau 1 – 4 + Hofdiener Gge.	On-roof	PV-Area: 1.045 m <sup>2</sup> + 1.630 m <sup>2</sup> (Hofdiener Gge.) Capacity: 181 kWp + 282 kWp
		In-roof	PV-Area: 1.720 m <sup>2</sup> Capacity: 246 kWp
		Solar tiles	PV-Area: 1.800 m <sup>2</sup> Capacity: 162 kWp
		Facade - PV	PV-Area: 430 m <sup>2</sup> + 870 m <sup>2</sup> (Hofdiener Gge.) Capacity: 73 kWp + 134 kWp
	<b>Building refurbishment</b> Bau 1 - 4	Standard	Insulation of cellar ceiling + roof
		Pilot	Insulation of cellar ceiling + roof + facade Window replacement (triple glazing)
	<b>Heat supply</b> Campus	CHP	1. CHP: electricity base load 120 kW <sub>el</sub> / 143 kW <sub>th</sub> 2. CHP: heat demand 237 kW <sub>el</sub> / 365 kW <sub>th</sub>
		Heat pump	sewage heat usage 679 kW <sub>th</sub> / COP = 2,6
		CHP + HP	CHP: 237 kW <sub>el</sub> / 365 kW <sub>th</sub> Sewage-HP: 679 kW <sub>th</sub> / COP = 2,6

#### 6.22.4 Status of Development

Energy savings for all measures have been either calculated or simulated with the SimStadt simulation platform. Additionally, a dynamic feasibility calculation for all measures has been performed. Some of the proposed measures have already been implemented (LEDs BAU 3, refurbishment BAU 4). A roadmap for the “climate-neutral campus by 2030” has been developed and approved by the Department of Treasury of the state of Baden-Württemberg. They also committed to fund additional measures (e.g., PV on all buildings plus the public

parking garage, see Table 43). Table 44 lists additional Information on HFT Campus modernization. Figure 115 shows the effects of measure packages of HFT Campus Stuttgart. Table 45 lists investment costs for modernization.

**Table 43. Packages of measures for HFT Campus in Stuttgart.**

Package of measures		„Minimal invasive“	„Standard measures“	„Hofdiener“	„Lighthouse“
Lighting	LED installation	X	X	X	X
	Light control	X	X	X	X
HVAC	Radiator valves	X	X	X	X
	Circulating pumps	X	X	X	X
Renewable Energy	On-roof	X	X	X	X
	In-roof				
	Solar tiles				
Building Envelope	Facade - PV			X	X
	Standard		X	X	X
Energy Systems	Pilot				
	CHP				
	Heat pump				X
CHP + HP					X
<b>Capital costs [Euro]</b>		<b>710.000</b>	<b>1.615.000</b>	<b>1.960.000</b>	<b>3.260.000</b>
<b>Payback period [a]</b>		<b>5,7</b>	<b>8,8</b>	<b>8,9</b>	<b>14,1</b>
<b>CO<sub>2</sub> savings [tCO<sub>2</sub>/a   %]</b>		<b>180 t   28 %</b>	<b>310 t   47 %</b>	<b>525 t   80 %</b>	<b>890 t   134 %</b>

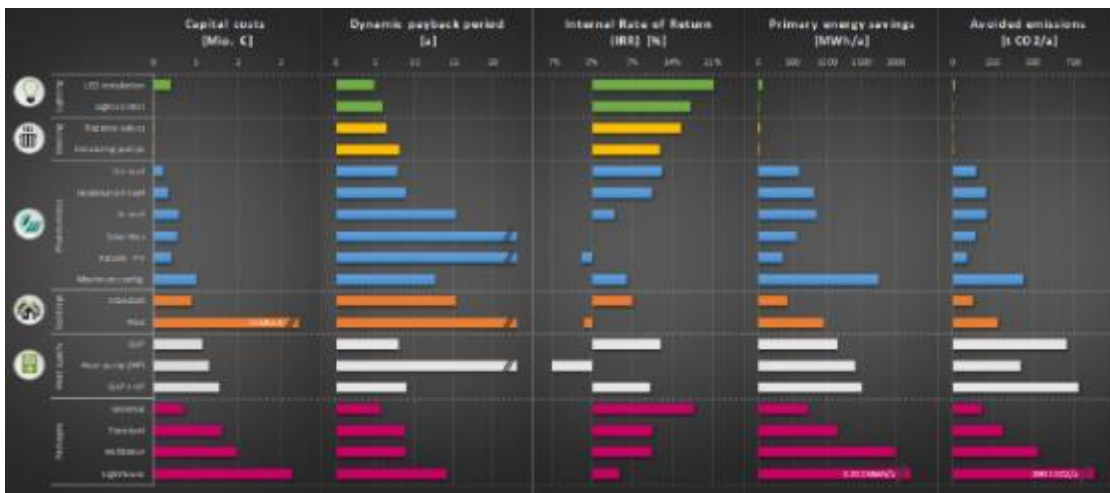

**Figure 115. Effects of Measure Packages of HFT Campus Stuttgart (Source: EnSign Reallabor HFT Stuttgart).**

**Table 44. Additional Information on HFT Campus modernization.**

<b>Building mix in the area*:</b>	28,850 m <sup>2</sup> heated area (public buildings/research & university)
<b>Consumer mix in the area**:</b>	100% medium size users
<b>Energy plant owner (public or private):</b>	existing heat supply is partly private
<b>Thermal energy supply technologies***:</b>	heat pump (one newly constructed building), district heating
<b>Cooling energy used:</b>	440 [MWh/a] (electric demand for cooling 190 MWh/a → EER 2.3)
<b>Available cooling power:</b>	Q <sub>th</sub> = 580 kW <sub>th</sub> (P <sub>el</sub> = 220 kW <sub>el</sub> ) (only 40% of cooling power currently in use)
<b>Electrical energy demand:</b>	1,900 MWh/a ( from measurement)

Voltage level:	220/400 V
Electric power supply technologies:	Grid
Backup power, critical demand:	30 kWel for data center/servers

**Table 45. Investment costs for modernization excluding + 20% for planning & + 19% taxes.**

<b>Energy generation (costs including assembly and commissioning)</b>		
Solar thermal collectors (FPC)	200	€/m <sup>2</sup>
Heat pump	310	€/kWth
Heat pump (water heat exchanger)	290	€/kWth
CHP plant - 120 kWel	1050	€/kWel
CHP plant - 240 kWel	750	€/kWel
Absorption chiller	550	€/kWth
Energy central/Buildings	500,000	€
PV modules, including cables, inverter, installation		
Rooftop	750	€/kWp
Facade	1250	€/kWp
Rooftop/facade	15%	of module costs

### 6.22.5 Technical Highlight

**Different combinations of energy supply scenarios** consisting of photovoltaics (PV) and solar thermal collectors, cogeneration of heat and electricity (CHP) (and cooling in combination with absorption refrigeration), heat pumps (HP), conventional cooling (VCRS), and the existing heating network were developed:

- Since a **special wastewater heat pump with high temperature output** for use in existing buildings was chosen, which resulted in no need to change existing high temperature radiators.
- Furthermore, *various innovative supply scenarios were examined (e.g., fuel cell, nearby park as underground surface heat source and storage [Agrothermie])*

For **10 different system combinations** a detailed dimensioning and calculation of the supply scenario was conducted:

- Analysis of primary energy demand, CO<sub>2</sub>-emissions, and economy efficiency
- Selection of three supply systems with the highest future proof potential (CHP, HP, CHP + HP)
  - Existing heating network is always used as backup
  - Potential excess heat can be fed into existing heating network
  - PV is preferred to solar thermal, because of low heat demand in summer
  - Almost **100% of PV generation can be used directly** at the campus, nearly 1/3 of the power demand are supplied by PV generation.

Figure 116 shows the load profiles (left side: heating, right side: electricity) for two of those supply scenarios. The top one for a heat supply with a monovalent (wastewater) HP in combination with on-roof PV on BAU 1-4 and the Hofdiener Garage. The bottom one shows a combined supply with a CHP for the power and heat base load, a HP for the heat medium load and the heating peak load is supplied by the existing heat network. Figure 117 shows the energy system, scenario CHP + wastewater heat pump + district heating + PV.



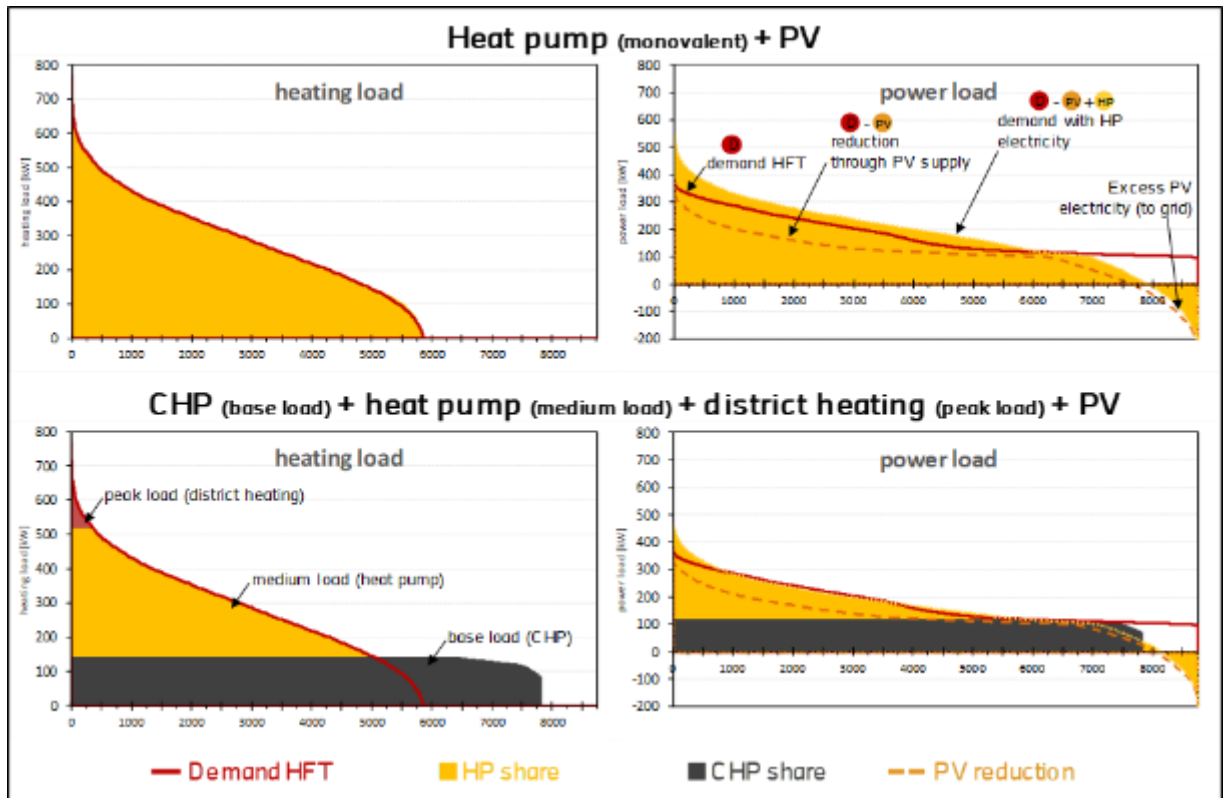

Figure 116. Load profiles for energy system scenarios. wastewater heat pump + PV (top) CHP + wastewater heat pump + district heating + PV (bottom) (Source: EnSign Reallabor HFT Stuttgart).

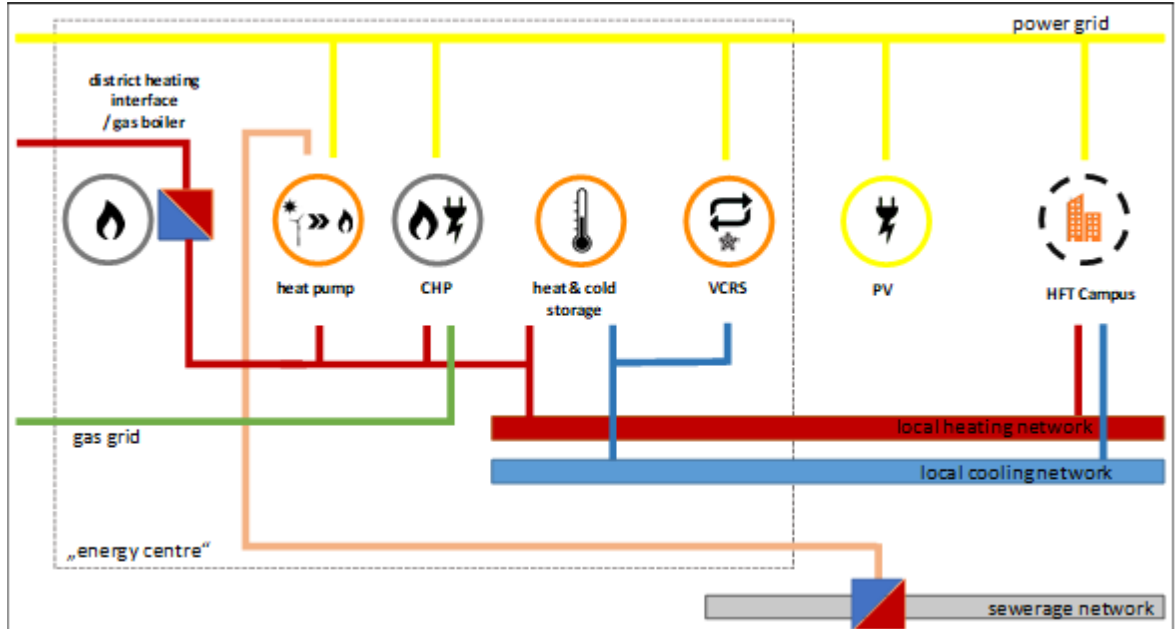

Figure 117. Energy system, scenario CHP + wastewater heat pump + district heating + PV (Source: EnSign Reallabor HFT Stuttgart).

## 6.22.6 Decision and Design Process

### 6.22.6.1 General/Organizational Issues

Why was this project initiated, to answer which need?

*The goal of the federal state of Baden-Württemberg is to have a climate-neutral state government (including university buildings) by 2040. Additionally, there are energy guidelines/a development plan (Energieleitplan) by the City of Stuttgart. This leads to the lighthouse project of a climate-neutral HFT Campus by 2030, which was developed in the new research format "Reallabor."*

Which stakeholders were involved in the project?

*Stakeholders included urban planning, architecture, renewable energies, geoinformatics, economy, psychology, and the Center for Sustainable Development (Figure 118).*

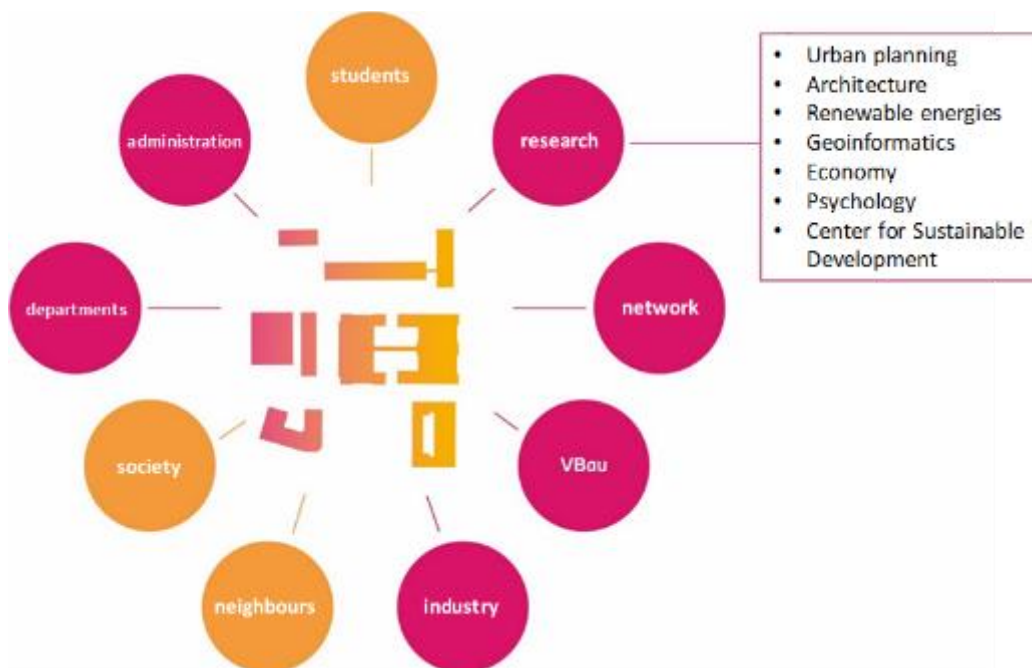

**Figure 118. Stakeholders in EnSign Reallabor (Source: EnSign Reallabor HFT Stuttgart).**

Which resources were available before the project? What are local energy potentials?

*Research network at HFT (IAF, zafh.net, etc.), preliminary studies for the energy potential*

Who (what) were drivers and who (what) were opponents (barriers) – and why?

- **Drivers:** *Collaboration on operational level was very flexible and target-oriented.*
  - *Organization of creative workshops and co-creation processes*
- **Barriers:** *Coordination of all stakeholders, communication with administration*
  - *no contract renewal for several staff members at the end of the project*

What have been the main challenges regarding decision finding?

*Coordination of all stakeholders, communication with administration*

What was finally the crucial parameter for go /no-go decision?

*Engagement of management team.*

*Forthcoming commitment of the federal state (responsible administration = Department of the Treasury) for further funding of the lighthouse project (e.g., PV).*

### 6.22.6.2 Financing Issues

What have been the main challenges/constraints regarding financing?

*Different options for the financing of the proposed measures were considered and discussed with the project-partner "Stuttgart Financial" and other experts. Among them were intracting, contracting, green bonds or crowd-investing. In the end, the Department of Treasury Baden-Württemberg agreed to finance the methods and the other options were not needed anymore. However, the ideas can be applied to future projects.*

### 6.22.6.3 Technical Issues

What have been major technical challenges/constraints regarding system design?

- *Most of the HFT buildings are historically protected ("Denkmalschutz"), therefore, no standard solutions concerning refurbishment are possible. Different individual measures have to be designed for every building. Additionally, since the temperature level is very high for the existing heating radiators, a special heat pump for a high temperature level is needed.*
- *The district heating that is connected to the campus already, has a very low primary energy factor despite the fact that the heat and power generation is done mainly with coal. Consequently, the considered scenarios for other energy generating systems are calculated with the same standards.*
- *The primary energy factor for heat from cogeneration is low in this case because most primary energy is assigned to power, which gets a primary energy factor of 2.8 even though from 50% coal and 50% waste, whereas the recovered waste heat only gets a very low rest factor. ("Stromgutschriftmethode" [https://www.ffe.de/download/wissen/334\\_Allokationsmethoden\\_CO2/ET\\_Allokationsmethod\\_en\\_CO2.pdf](https://www.ffe.de/download/wissen/334_Allokationsmethoden_CO2/ET_Allokationsmethod_en_CO2.pdf)). The Campus already obtains green electricity from the grid. The question arises, how self-produced PV and CHP electricity is credited to achieve a fair comparison.*
- *Also, the development of the primary energy factors is uncertain, so it is difficult to calculate scenarios and take the possible changes into account.*

What solutions have been considered for generation, storage and load management?

- **Heat:** *CHP, fuel cell, (wastewater) heat pump, solar thermal, low geothermal heat (Agrothermie), district and local heating networks, water storage*
- **Electricity:** *CHP, fuel cell, PV(T)*
- **Cooling:** *Combined Cooling, Heat and Power (CCHP) with absorption refrigeration, VCERS, free cooling.*

### 6.22.6.4 Design Approach Applied

Which decision steps/workflow lead to the retained solution?

*Step 1:*

*First of all, a catalogue of measures and the prioritization of measures were identified. After that, different refurbishment scenarios as well as PV roof and facade scenarios (on-roof, in-roof, solar tiles) in regard to the historic value of the buildings (e.g., internal insulation instead of external) have been reviewed.*

*Furthermore, onsite inspections were undertaken and energy consumption for lighting, circulating pumps and thermostatic radiator valves were estimated. Then, the energy savings*

potential was calculated. (All scenarios integrate the neighborhood or can be transferred to neighborhood buildings.)

Step 2:

The heat demand is simulated and validated with SimStadt, afterwards, the different refurbishment scenarios are calculated to show the heat demand reduction potential (see Figure 119). Then, the PV scenarios are calculated using INSEL and PVsol for the shading calculations.

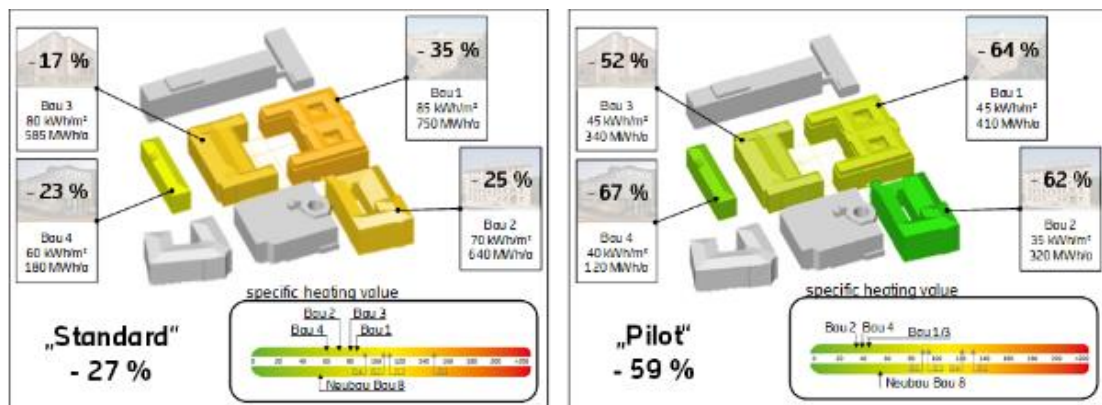

Figure 119. Heat demand in “Standard” and “Pilot” refurbishment of the campus (Source: EnSign Reallabor HFT Stuttgart).

Step 3:

Different energy supply scenarios are calculated: Various combinations of PV // solar thermal // CHP // HP // VCRS // absorption refrigeration // existing heating network. Then, 10 different system combinations are dimensioned and primary energy demand, CO<sub>2</sub>-emissions and economy efficiency are calculated. Of these combinations, three supply systems with the highest future potential are chosen.

Step 4:

The different measures are combined to packages and a roadmap for the “climate-neutral campus by 2030” is developed out of all examined measures (Figure 120).

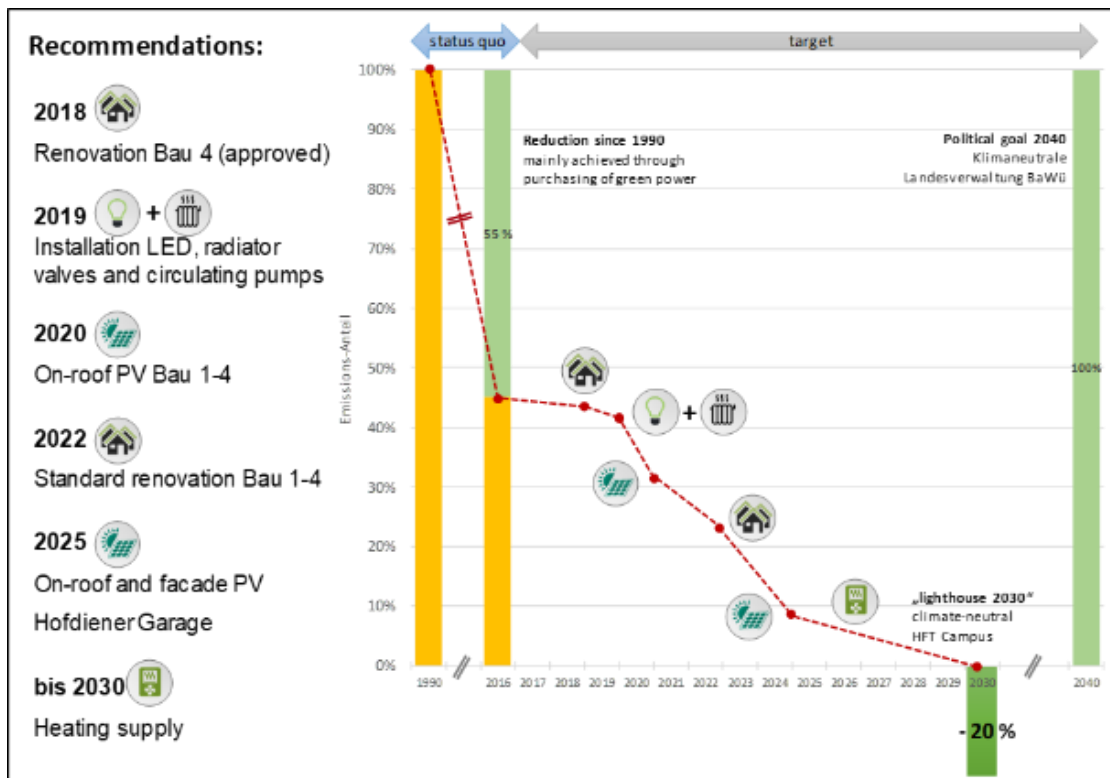

Figure 120. Roadmap climate-neutral HFT Campus by 2030 (Source: EnSign Reallabor HFT Stuttgart).

Which tools have been used during the design phase? Include name, originate (plus web link), purpose of the tool, specific use of the tool within the case study, practical experiences during application, cost/price (if commercial tool).

- Heat demand and refurbishment scenarios: Simstadt ([http://www.ibpsa.org/proceedings/bausimPapers/2012/BauSIM2012\\_103.pdf](http://www.ibpsa.org/proceedings/bausimPapers/2012/BauSIM2012_103.pdf))
- Energy supply scenarios and PV generation: INSEL ([www.insel.eu](http://www.insel.eu)), PVSol
- Economic efficiency calculation: HFT developed Excel Tool

What have been the most crucial interfaces?

Architectural drafts for PV and refurbishment scenarios (in regard to the historic value of the buildings) → simulation of heat demand and refurbishment scenarios → energy supply scenarios and PV

What parameters are controlled via monitoring?

All monitoring system at the HFT have been inspected and the necessary steps for implementing them on one platform were determined. The goal is to monitor all heat and power meters of all buildings, as well as cooling units, etc. Furthermore, there was a test-monitoring for human centric lighting in one of the lecture rooms and also an office room. Also, the mobility behavior of the students and staff members was evaluated with a survey. The HFT is also one of about 20 out of 450 universities in Germany certified with EMAS (Eco Management and Audit Scheme) to manage and continuously improve the environmental performance of the institution.

## 6.22.7 Resilience

In future energy generation scenarios, the connection to the district heating system (which is the current form of energy supply for the campus) remains intact. This way, in case of failure

or malfunction of any of the newly installed heat generating systems, the demand of the campus can still be satisfied.

For the supply with electricity, the campus is connected to the local grid. The downtimes of the grid are very low in Germany, in 2018 it was only 13.9 minutes.\* The only critical loads are the ones from the data center. There is already a backup power supply, so that the systems can be shut down orderly in case of emergency without a sudden breakdown.

The cooling systems in Building 2, where the data center and the library are, include a redundant system that can uphold a minimum operation during downtime (e.g., because of planned maintenance) of the other systems.

## **6.22.8 Lessons Learned**

Unfortunately, none of the energy generation scenarios have been implemented yet. Therefore, no lessons learned or success factors for this area can be identified yet. The main focus of this section is therefore on the processes that come before implementation, as well as implementation of small measures such as thermostats in offices.

### **6.22.8.1 Major Success Factors**

- Existing knowledge and experiences of the research team as well as the included network from similar projects
- Engagement of management team in bringing together different disciplines of research (e.g., energy engineers and business psychologists)
- Good communication and team spirit on the working level of the research team
- Integration of students in form of theses (bachelor, master, project) as well as student researchers.

### **6.22.8.2 Major Bottlenecks**

- Communication with the HFT administration and stakeholders outside of the university
- Coordination of some tasks need more adjustment to prevent duplication of efforts (e.g., refurbishment scenarios should be final before simulation, etc.)
- Ensuring financing by the administration of the planned/simulated measures takes a long time and could not be finalized during the project duration.



### **6.22.8.3 Major Lessons Learned**

- Simulation tools provide reliable results but need reliable input information
- Detailed simulations are not necessary in some situations
- Engagement of students and staff is very important when measures are implemented (e.g., information of staff is important when installing thermostats, so that they know how it works, how they can change the settings and what are the actual energy savings through that measure).

---

\*[https://www.bundesnetzagentur.de/DE/Sachgebiete/ElektrizitaetundGas/Unternehmen\\_Institutionen/Versorgungssicherheit/Versorgungsunterbrechungen/Auswertung\\_Strom/Versorgungsunterbrech\\_Strom\\_node.html](https://www.bundesnetzagentur.de/DE/Sachgebiete/ElektrizitaetundGas/Unternehmen_Institutionen/Versorgungssicherheit/Versorgungsunterbrechungen/Auswertung_Strom/Versorgungsunterbrech_Strom_node.html)

## 6.23 School Campus in Detmold, Germany

Case No.	Country	Location	Specific Type	Photo	Special points of attention
23	Germany	Detmold	Campus Education Campus		 solar energy, building efficiency

This content is taken from the ASHRAE publication [Roser, Annette & Schakib-Ekbatan, Karin & Weiler, Verena & Eicker, Ursula & Lohse, Rüdiger. (2020). "Net-Zero Energy Strategies and Planning Support Tools for Campuses and Residential Neighborhoods in Germany."]

### 6.23.1 Background and Framework

The school campus in Detmold (Figure 121) comprises three buildings from the late 1950s retrofitted between 2010 and 2015. The buildings of the two vocational schools (Berufskolleg), the "Felix-Fechenbach-Berufskolleg," and the "Dietrich-Bonhoeffer-Berufskolleg," which serve around 3,600 students, were thoroughly renovated. The aim was to achieve a significant improvement in energy efficiency and to improve the quality of the school stay. With an energy-related surface of 9,373 m<sup>2</sup> and a poor energy demand of 272.3 kWh/m<sup>2</sup> and year, the goal of a plus energy campus was challenging. The measured consumption was 38.7 kWh/m<sup>2</sup> in 2016, reaching even a lower value than calculated. An intensive monitoring of energy consumption, indoor quality, and user satisfaction is still ongoing.



Figure 121. View on the School Campus Detmold (Source: Pape or Semke Architectural Office).

The heating energy consumption of 42.2 kWh/m<sup>2</sup>a of the Felix-Fechenbach and Dietrich-Bonhoeffer vocational colleges in Detmold, which is covered by district heating, reflects the value calculated in advance very well (Figure 122). Hot drinking water consumption is clearly above the calculated requirement and extremely high at 23.5 kWh/m<sup>2</sup>a. The upgrade of the previously uninsulated domestic hot water network and the shutdown of irrelevant areas are still being implemented. The high consumption is due to the fact that two oversized circulation pumps have to send the hot drinking water through old pipes over almost the entire campus and have to work with a high flow rate due to the large thermal losses to minimize the drop in temperature of the hot drinking water to ensure drinking water hygiene. No separate measurements are available for lighting and ventilation.

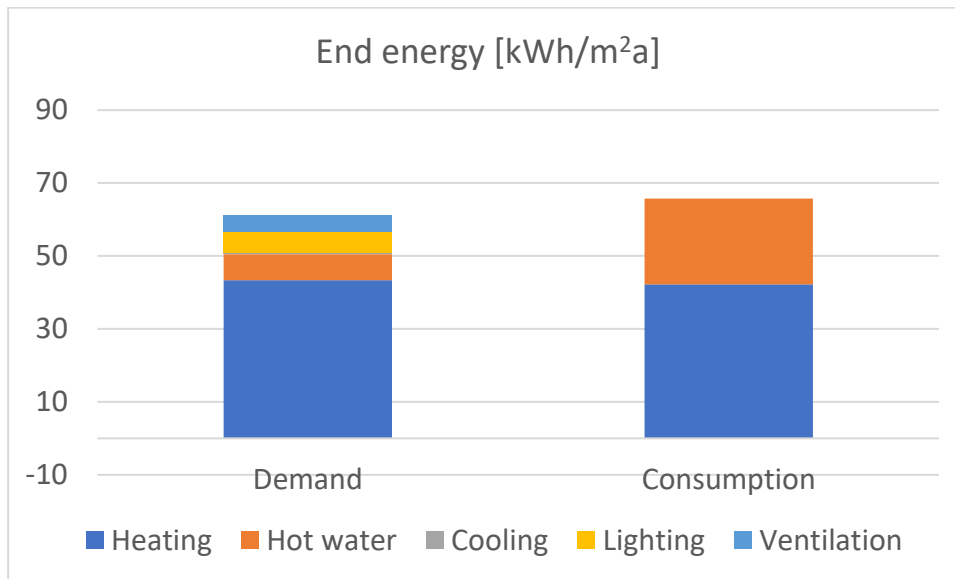
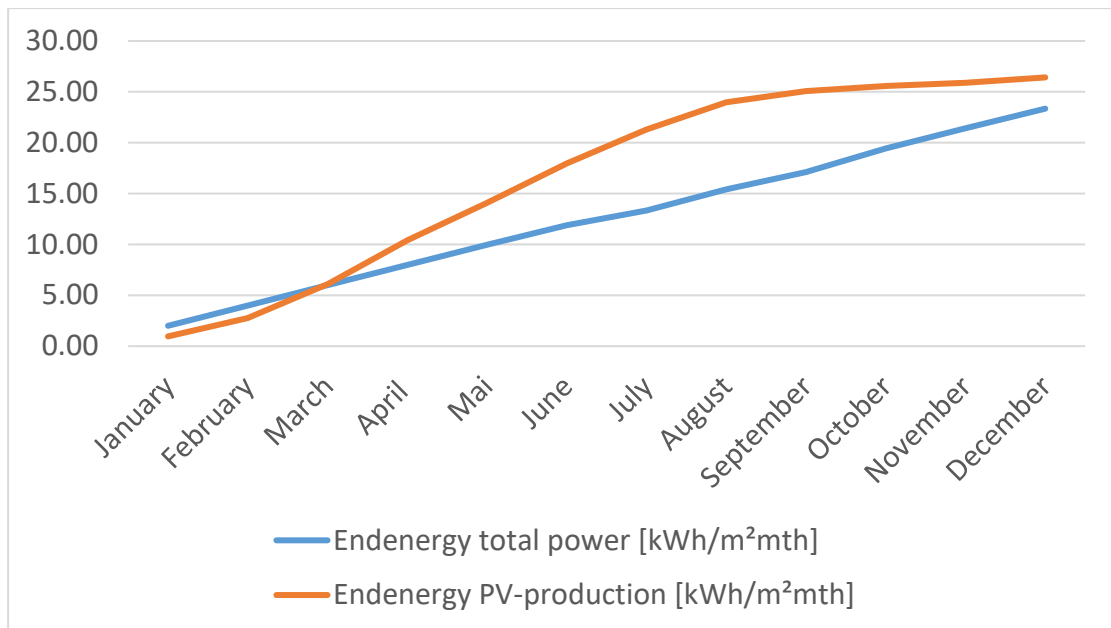

**Figure 122. End-energy demand and consumption in 2016.**

### 6.23.2 Energy Targets

The original energy goal of the Felix-Fechenbach und Dietrich-Bonhoeffer-Berufskolleg in Detmold was primarily to reduce energy consumption, especially as it relates to consumers heating, domestic hot water, lighting, and ventilation. The very favorable primary energy factor of the adjacent district heating of 0.0 and the large PV system on the buildings makes it possible to meet the primary energy plus energy balance for the total energy consumption of the buildings (including user electricity) (see Figure 123).





**Figure 123. Energy production and energy consumption in 2016 (Source: Fraunhofer IBP).**

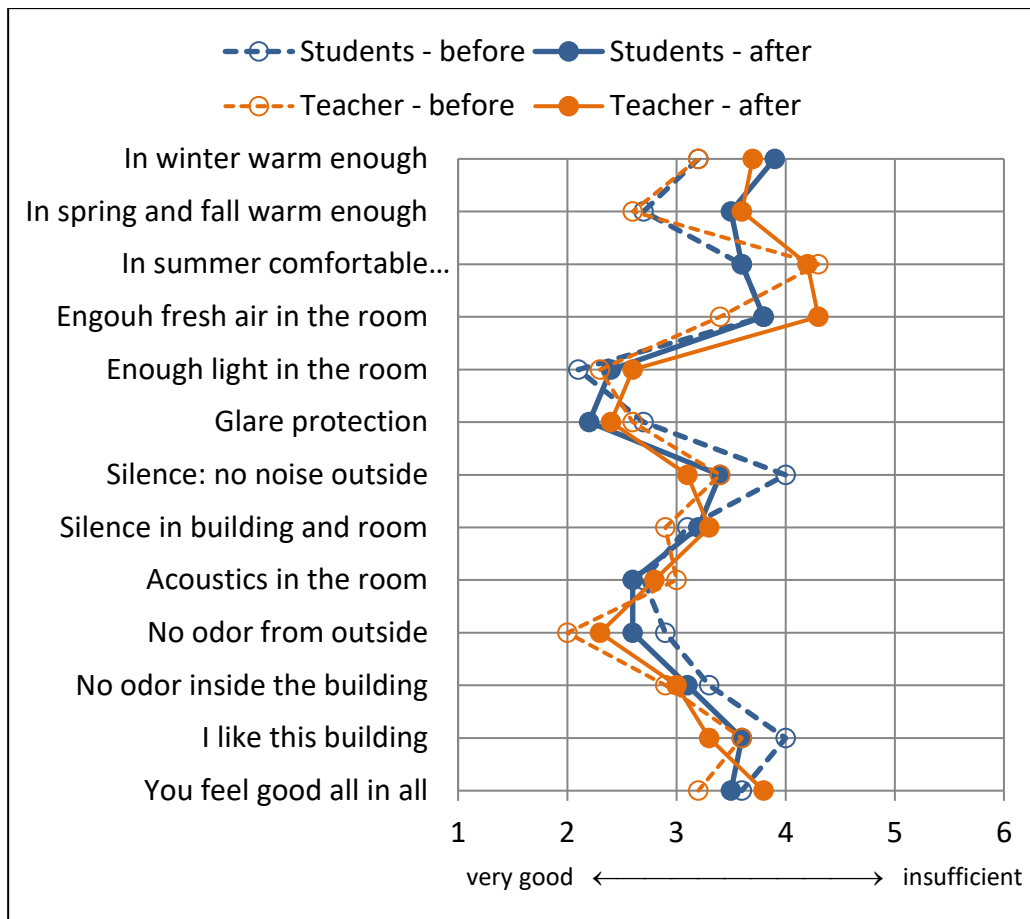

Before and after the implementation, surveys, interviews, and group discussions were conducted to determine the well-being of students and teachers, and their acceptance of the new technologies that support energy efficiency. The analyses show that well-being and learning conditions in the retrofitted buildings could be increased. However, the comfort experienced varied in detail, e.g., temperatures or indoor air quality were rated poorer than expected, partially due to an uncomfortable usability of control options (Figure 124). Due to these results, readjustments are still in progress.



**Figure 124. Evaluation of different parameters by students and teachers (from 1 = very good to 6 = insufficient).**

From the perspective of energy conservation, the project in Detmold can already be considered as successful when looking at the first year of monitoring. The primary energetic plus energy target could be achieved. Problems only arose with the control of the existing radiators that were still used for heat transfer, which led to a significant overheating of the rooms in summer and in the transition period (see also the evaluation results in Figure 124). A further problem was the extremely high energy consumption for domestic hot water preparation. Both problems are still being addressed by a monitoring team from the accompanying university of the project (University of Applied Sciences Ostwestfalen-Lippe). Better results are expected in the second year of measurement.

## 6.24 Rinheim District in Karlsruhe, Germany

Case No.	Country	Location	Specific Type	Photo	Special points of attention
24	Germany	Karlsruhe Rintheim	Energy Supply System/ District		 district energy system

This content is taken from the ASHRAE publication [Roser, Annette & Schakib-Ekbatan, Karin & Weiler, Verena & Eicker, Ursula & Lohse, Rüdiger. (2020). Net-Zero Energy Strategies and Planning Support Tools for Campuses and Residential Neighborhoods in Germany.]

### 6.24.1 Background and Framework

The project “Future proof neighborhood development” was carried out in Karlsruhe Rintheim from 2008 to 2013 by the social housing company *Volkswohnung*. Rintheim is a district of Karlsruhe, where the *Volkswohnung* owns some 30 multifamily houses (Figure 125). The residential building area dates to the years 1954 to 1970.

As the third largest municipal real estate company in Baden-Württemberg, the *Volkswohnung* offers for nearly 100 years now affordable and high-quality living space to the citizens of Karlsruhe. It owns and manages over 13,200 rental apartments for young, old and/or disabled people, singles, couples, and families. The company is committed to energy efficiency. Therefore, new construction activities and modernization measures are closely linked with energy efficiency and energy-saving potential – as shown in the present research project. Due to these activities, the *Volkswohnung* was able to state that, after completion of an energetic renovation, the existing properties fell short of the new building standard according to the Energy-Saving Ordinance, in some cases by 25% to 30%. Extensive modernization and new energy concepts have also halved the primary energy requirement in the properties. The *Volkswohnung* thus meets a large part of the CO<sub>2</sub> reduction targets of the agenda of the City of Karlsruhe.



**Figure 125. Rintheimer Feld (Source: Volkswohnung).**

In this project, the *Volkswohnung* retrofitted 14 buildings in a neighborhood in Karlsruhe Rintheim at a cost of approximately 70 million Euro. At the same time, the neighborhood area was connected to the local heating network. By involving the tenants, a residential environment improvement concept was drawn up and implemented.

For research purposes, different heating systems and different insulation levels have been implemented in three buildings with 30 flats each. The energetic levels were fixed to a standard retrofitting of the Volkswohnung (building 1), a three-liter-house level (building 2) and a passive-house standard (building 3). The different thermal insulation variants were combined with the different system variants in such a way that ultimately seven different variants were created.

### 6.24.2 Results from Monitoring Phase

The results (Figure 126) show a decrease in primary energy demand from 174 kWhPE/m<sup>2</sup> to 28 kWhPE/m<sup>2</sup>. This analysis of the Rintheim neighborhood project shows that a combination of building measures and a (new or existing) highly efficient local energy system is the most cost-effective way to achieve energy and CO<sub>2</sub> targets. With an integrated overall concept for the neighborhood, it is possible to combine an energy-efficient energy system with cost-efficient measures on the building side to achieve even demanding energy targets at reasonable costs. This requires optimal planning, implementation, and optimized operation.

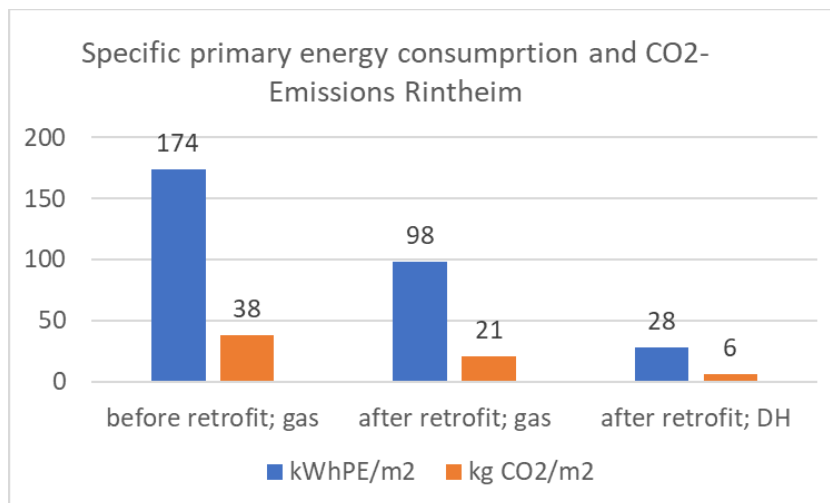

**Figure 126. IEA Annex 51 Energy efficient communities – German case study (Source: Jank, Reinhard).**

However, some buildings showed a higher consumption than before retrofit. The energy demand values calculated in advance of the measures deviate significantly from the measured energy consumption. This phenomenon is described in the literature as an energy performance gap. The influence of the user in buildings with complex, sophisticated system technology often leads to increased energy consumption. Thus, a follow-up project was funded (2012 to 2015) called “The impact of the rebound effect on the refurbishment of the existing building stock.” Intensive monitoring was done in the three above-mentioned buildings with differing results.



In this case, measured data with respect to temperature and humidity are shown in building R3 with the three entrances E1, E2 and E3 and the different flats. The average temperature of the flat is shown top left, average humidity is shown top right. Figure 127 (bottom left) shows the percentage of time when a window was open, and Figure 127 (bottom right) shows the CO<sub>2</sub> concentration as criteria of air quality. The value in the middle of the field is the heating energy consumption in kWh/m<sup>2</sup> (see Figure 127).

	R3.E1		R3.E2		R3.E3	
4.OG	21.9°C 33 % 8.8	22.5°C 35 % 4.8	22.9°C 19 % 7.5	23.6°C 29 % 7.3	23.1°C 31 % 4.6	23.1°C 19 % 8.5
3.OG	23.8°C 30 % 0.4	22.7°C 30 % 0.2	24.0°C 25 % 9.5	22.2°C 31 % 0.3	19.8°C 31 % 3.2	23.3°C 22 % 4.0
2.OG	23.5°C 43 % 2.5	23.3°C 33 % 2.7	25.3°C 25 % 6.3	23.4°C 21 % 4.5	23.7°C 26 % 11.3	22.5°C 29 % 3.1
1.OG	16 % 1121 ppm 23.1°C 28 % 3.7	5 % 707 ppm 23.9°C 26 % 0.0	30 % 664 ppm 24.7°C 24 % 14.0	2 % 496 ppm 21.5°C 26 % 0.8	14 % 519 ppm 22.1°C 27 % 1.6	4 % 740 ppm 21.6°C 26 % 0.5
EG	1 % 633 ppm 20.7°C 29 % 0.3	32 % 788 ppm 21.3°C 33 % 4.7	31 % 710 ppm 22.7°C 25 % 6.8	20 % 617 ppm 20.9°C 29 % 7.7	9 % 458 ppm 21.3°C 33 % 6.8	15 % 496 ppm 23.7°C 20 % 9.0
	1 % 457 ppm	22 % 698 ppm	22 % 615 ppm	22 % 896 ppm	5 % 662 ppm	14 % 443 ppm

Figure 127. Monitoring values in February 2013 (Source: Osterhage 2016).

There are some explanations for these results. For example, the location of the flat (orientation to the inside or outside), orientation to the north and south, etc. Last but not least, the behavior of the tenants also makes a difference. The project team intervened in some measures, and conducted interviews with tenants, information events at the beginning of the heating period, and accompanying surveys. In the course of these measures, the tenants are taught the correct use of the heating and ventilation system as well as the basic principles of ventilation behavior. These interventions led to significantly lower values in 2013 than in 2012. Unfortunately, there is still a gap left between consumption and demand values. It is assumed that an operational optimization of the technical installation and a continuous information and communication system could reduce this gap further.

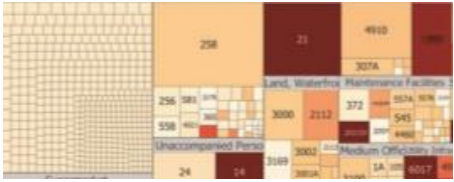
## 6.25 Energy Planning for Military Town in Guam

Case No.	Country	Location	Specific Type	Photo	Special points of attention
25	USA	Guam	Campus Military Town		  renewable sources, critical infrastructure

This content is taken from Urban et al. (2020).]

### 6.25.1 Installation Background

Unique to the geographic region of Guam, there are actually three installations collocated (or planned) on the island—the Naval Base Guam (NBG), Andersen Air Force Base (AAFB), and a future new installation for the Marine Corps.

The Joint Region Marianas Comprehensive Energy Investment Plan (CEIP) was developed as a pilot study to assess, improve, and integrate energy infrastructure and achieve regionally prioritized goals within a timeframe of 20 years. The pilot study was unique in many respects, but two aspects were particularly noteworthy. First, the study expanded the typical focus of energy plans from conservation to include energy security and resilience as the primary goal. Second, the study integrated efforts across three bases—NBG, AAFB, and a future new base for the Marine Corps into a regional plan (Figure 128.).

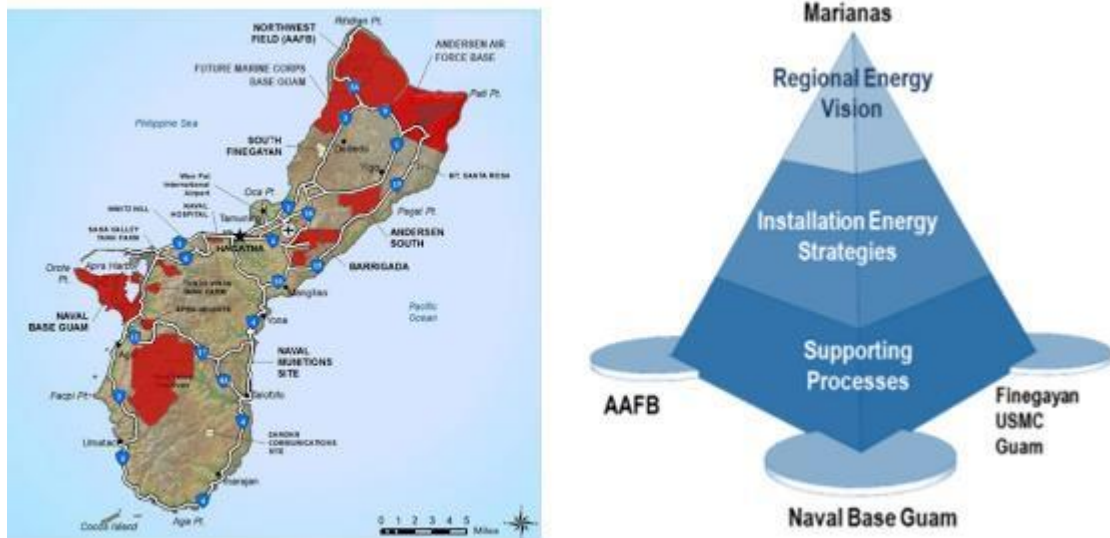

**Figure 128. Guam U.S. Department of Defense (DoD) Installations and the Joint Marianas Region CEIP.**

### 6.25.1.1 Modeling Energy Assessment and Energy Projects

The Joint Region Marianas (JRM) footprint on Guam accounts for around 15 million square feet (Msf or 1.4 km<sup>2</sup>) of facilities in 2016 that have an average daily peak of around 50 MW (180,000 MJ) and a critical load of around 11 MW (39,600 MJ). With significant expansion of missions on the island, including the construction of a brand-new base for the Marines, this footprint is projected to increase by 5 Msf (465 m<sup>2</sup>) to nearly 20 Msf (1,858 m<sup>2</sup>) by 2035 and correspondingly increase the peak energy daily load by 30 MW (108,000 MJ) to 78 MW (280,800 MJ) with a critical load of 21MW (75,600 MJ). The new demand was projected using the Navy’s Unified Facilities Criteria (UFC) for Sustainable Buildings (NAVFAC 2014) that set a 30% improvement over ASHRAE 90.1 2013 standard for different building types.

An analysis of Energy Use Intensities (EUIS) across each installation indicated that there was considerable variation in the mix of building typologies within each base (see Figure 129.). The analysis also revealed that, out of the 2,700 individual facilities, the top 100 energy-consuming facilities account for 50% of the total energy use and represent only 25% of JRM total facility spread across the different installations. This underscored the importance of using a regional prioritization approach to planning energy projects that would result in optimized ‘biggest bang for the buck’ outcomes.

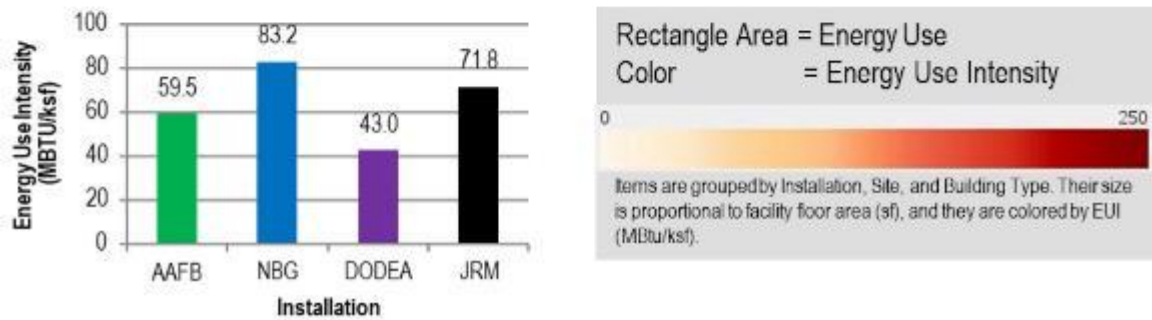
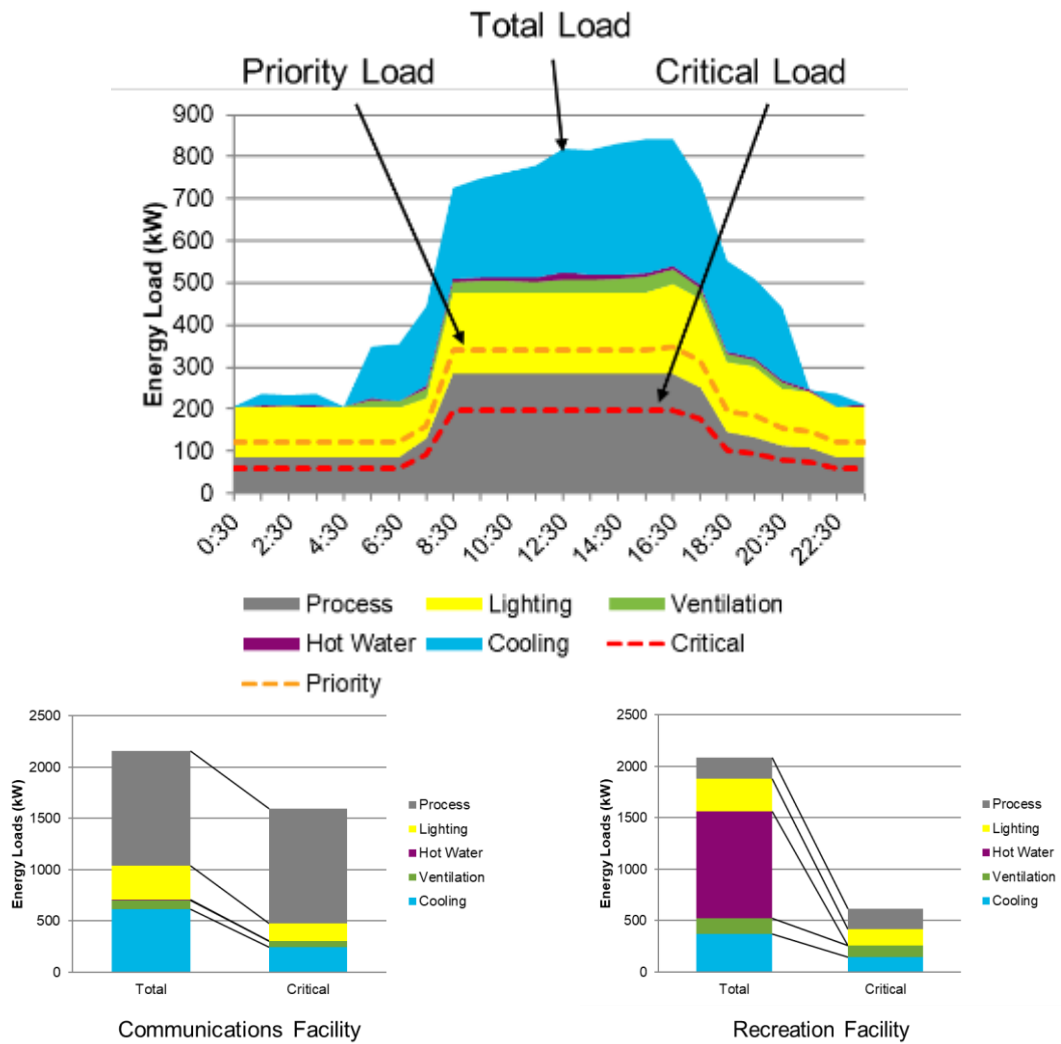

Figure 129. Facility energy use intensity pattern (Source: AECOM analysis).

Using energy models of prototypical buildings, typical Total Loads, Priority Loads, and Critical Loads for various buildings were analyzed (Figure 130). This information was essential in identifying energy conservation opportunities and estimating the impact of renewable technologies or district-based solutions such as central cooling systems and/or microgrids.



**Figure 130. Total and critical energy load estimation using modeling (Source: AECOM Energy Modeling).**

### 6.25.2 Goals and Strategies

Among the primary goals of the plan was to address energy resilience in support of mission assurance efforts. These included goals to

- Provide durable energy solutions
- Avoid single points of failure
- Ensure sustainable maintenance
- Use cost-effective energy strategies
- Meet required energy mandates and goals.

While Resilience did not have any prescribed performance benchmarks, the plan was required to meet specific Federal and DoD Energy Mandates such as the reduction of EUI by 25% by 2025 and increasing the renewable energy use component to 25% as per the Executive Order 13693 (White House 2015). In addition, the Secretary of the Navy’s aspirational goals of reducing energy consumption by 50% by 2020, using 50% alternative fuel sources (U.S. Congress 2017), and a base Net-Zero energy by 2030 were also to be seriously considered.



The CEIP was set against a background of increasing need for reliability and resilience due to a failing infrastructure on the island of Guam and the significant risk of super-typhoons with winds exceeding 175 mph (282 km/h). Between 2010 and 2015, there were more than 400 power outages recorded and the local utility, Guam Power Authority (GPA), had lost nearly 80 MW (80,000 KW) of generation capacity. With the DoD bases accounting for over 20% of the island's energy demand, all stakeholders prudently recognized that piecemeal efforts taken by individual entities were insufficient; a coordinated "One Guam" approach was needed to benefit the entire island's energy infrastructure. Note that GPA has since embarked on a multi-phase extensive grid modernization effort including the addition of 120 MW (120,000 KW) of renewable solar energy to their capacity by 2025.

The CEIP development followed a 12-step energy planning process (Figure 131.). The process included a robust energy assessment of existing conditions and implications of future development, followed by use of simulation models to evaluate energy outcome scenarios that meet energy and resilience goals. Finally, the process used an optimization model to generate funding and investments, constrained year-by-year, in a project action roadmap for implementation.

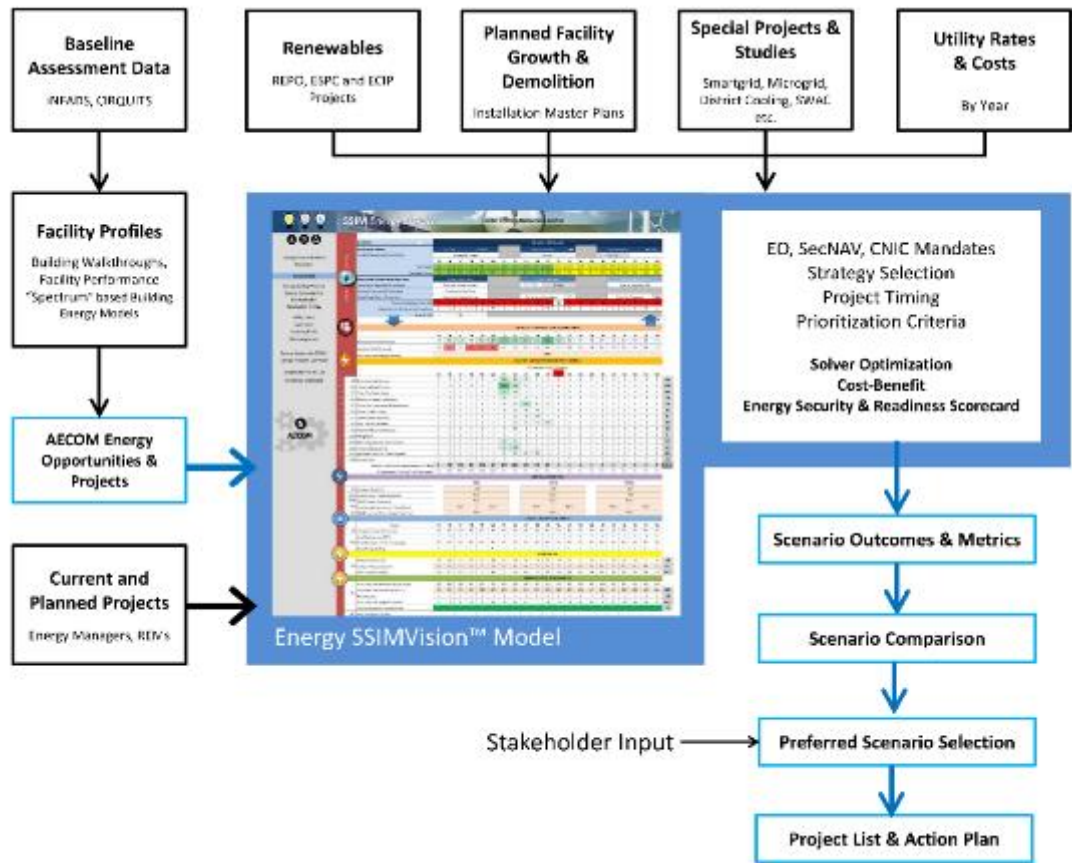

	SCENARIO 1	SCENARIO 2	SCENARIO 3	SCENARIO 4
<b>Name</b>	Business As Usual (BAU) + Government Planned Projects	Mandate Compliance	Resilient with Net-Zero MCRB	Resilient Plus
<b>Description</b>	Implements currently planned projects as per intended timeline, with below-average risk project cost escalation levels.	Implements only current and future planned projects that meet compliance.	Implements current planned projects and additional projects that maintain Regional Resilience while being cost-effective.	Implements Scenario 3 plus additional projects to maintain energy savings towards goal of Net-Zero.
<b>Scenario Goal</b>	Demonstrate Current Path Outcomes for JRM	Demonstrate what it would take to simply meet SecNav, CNIC, IJC O&M Goals	Determine key projects that best efficiently help maintain Resilience Score as per the Energy Security and Readiness Scorecard	Demonstrate implications of implementing SWAC and additional renewables towards Resilience and Net-Zero
<b>Measures &amp; Key Actions</b>				
<b>Energy Conservation Projects (ECMs)</b>	Implements measures reports to facility level actions over 5 years across AFB and NCB. Includes currently planned projects through 2020 and then new projects at an average investment of \$150k per year from 2021-2024. Average payback is set at < 10 years for each year bundle.	Implements measures reports to facility level actions over 8 years across AFB and NCB. Includes currently planned projects through 2020 and then new projects in years 2021-2024 at investment of \$6M/yr, and 2025 and 2026 at \$11M/yr.	Implements measures reports to facility level actions over 11 years across AFB and NCB. Includes currently planned projects through 2020 and then new projects at an average investment of \$10M in 2021 to 2021 to \$5M by 2025.	Implements measures reports to facility level actions over 12 years across AFB and NCB. Includes currently planned projects through 2020 and then new projects at an average investment of \$10M in 2021 to \$5M by 2025.
<b>Smart Grid</b>	Implements Smart Grid across all three bases. Costs for MCRB is assumed to be included as part of site development.	Implements Smart Grid across all three bases. Costs for MCRB is assumed to be included as part of site development.	Implements Smart Grid across all three bases. Costs for MCRB is assumed to be included as part of site development.	Implements Smart Grid across all three bases. Costs for MCRB is assumed to be included as part of site development.
<b>Microgrid</b>	No Microgrid projects are implemented in this scenario.	No Microgrid projects are implemented in this scenario.	Implements Microgrids across all three also connected to renewable power and battery storage.	Implements Microgrids across all three also connected to renewable power and battery storage.
<b>District Energy SWAC</b>	Implements District Cooling at MCRB as per Jacob Engineering study. SWAC is NOT considered for this scenario.	Implements District Cooling at MCRB as per Jacob Engineering study. SWAC is NOT considered for this scenario.	Implements District Cooling at MCRB as per Jacob Engineering study. SWAC is NOT considered for this scenario.	Implements District Cooling at MCRB as per Jacob Engineering study. SWAC is implemented by 2020 at both MCRB and NCB.
<b>Rooftop PV</b>	Implements currently planned Rooftop PV projects. NCB: 6.5MW over 300 ksq ft (10% of rooftop). AFB: 10MW over 700 ksq ft (30% of rooftop). MCRB: No Rooftop PV.	Implements currently planned Rooftop PV projects. NCB: 6.5MW over 300 ksq ft (10% of rooftop). AFB: 10MW over 700 ksq ft (30% of rooftop). MCRB: No Rooftop PV.	Adds to currently planned Rooftop PV projects. NCB: 6.5MW over 300 ksq ft (10% of rooftop). AFB: 12MW over 1.1M (10% of rooftop). MCRB: 9MW over 600 ksq ft (30% of rooftop).	Adds to currently planned Rooftop PV projects. NCB: 12MW over 650 ksq ft (10% of rooftop). AFB: 10MW over 1.1M (10% of rooftop). MCRB: 9MW over 600 ksq ft (30% of rooftop).
<b>Ground Based PV</b>	Implements all 5 REPO projects as Model 2a at 38MW and another 5MW as model 3 built with ESPC funding.	Implements all 5 REPO projects as Model 2a at 38MW and another 5MW as model 3 built with ESPC funding.	Includes Model 2, 3, 4 and NCB. Implements 4 REPO projects as Model 2a at 22MW and 27MW at South Fitzgerald site as Model 3 built by third party with a PPA. PV is used to maintain Net-Zero at MCRB.	Includes Model 2, 3, 4 and NCB. Implements 4 REPO projects as Model 2a at 22MW and 27MW at South Fitzgerald site as Model 3 built by third party with a PPA. Also includes 15MW dedicated PV at AFB. PV is used to maintain Net-Zero. Costs Net-Zero at MCRB.
<b>Battery Storage</b>	Does not include any Battery Storage.	Does not include any Battery Storage.	Includes Battery Storage connected to Microgrid at each site (20MWh at MCRB, 10MWh at AFB, 10MWh at NCB).	Includes Battery Storage connected to Microgrid at each site (20MWh at MCRB, 10MWh at AFB, 10MWh at NCB).

Figure 131. Energy scenario planning tool process and proposed scenarios.

## 6.25.3 Highlights

### 6.25.3.1 Innovative Energy Scenario Planning

The CEIP used an innovative simulation model to integrate the extensive facility-level data with conditions gathered and to generate various energy scenario outcomes that could be tested against the goals and performance targets set out by the CEIP Vision. The scenario process involved adjusting the model inputs and timing of proposed actions in accordance with various drivers or goals that a particular scenario pursued. Typical scenario drivers included:

1. *The Ability To Develop a ‘Strong’ Rating for Energy Security and Readiness Scorecard for JRM.* This means that all aspects of Readiness, Resilience, and Efficiency would have to be considered to maximize the scores. In particular, the decision to implement a Microgrid solution, the availability of the right amount of redundant renewable power to cover the critical facility loads at each installation, and the size of energy storage, all greatly influence the scores.
2. *The Need To Meet or Exceed Energy Mandates and Goals.* JRM is subject to various energy mandates and goals dictated by federal authority (Executive Order 13693 [White House 2015]), Department of the Navy (DoN 2011), and Commander, Navy Installations Command (CNIC). Although Energy Security is considered the primary driver, JRM is still obligated to show a best effort toward compliance with the targets. These goals have performance benchmarks at specific timelines that directly influence decisions on implementation timing of certain projects.
3. *Cost and Funding Level.* Overall capital investment and impacts on long-term operating budgets are also important drivers that influence choices in the scenario development process. The amount of funding per year for conservation projects is controlled to simulate current trends in funding of such projects or reflect anticipated lowering in funding availability in later years (after 2020). Decisions on whether renewable power is available as model 2 (feeding internal base demand) or model 3 (feeding back to the utility grid), or whether it is sourced from a power purchase agreement or directly owned and operated also influences the cost savings potential.
4. *Priorities for Individual Installations.* For JRM, the scenario development incorporates not only the perspective and targets of regional stakeholders, but also the priorities of the component installations. In this case, such development would include for example, NBG exploring rebuilding of the Orote Power Plant as part of its Microgrid solution or AAFB (which has limited land availability) being open to a more aggressive rooftop solar implementation.

Using AECOM’s Vision Simulation Tool, four scenarios were developed for the JRM leadership to decide on the roadmap forward (shown in Figure 129.). These scenarios ranged from a Business-As-Usual approach using current planned actions only, to highly resilient installations targeting Net-Zero Energy status by 2035. Each scenario implemented a combination of energy conservation measures; energy infrastructure projects such as smart-grid capabilities, district cooling, microgrids managing backup generation and battery storage; and renewable energy projects inside and outside the fence.

### 6.25.3.2 Designing for reliability, resilience, and efficiency

Another innovation used in the JRM CEIP was the Energy Security and Readiness Scorecard that provided a measurable way to assess the reliability, resilience, and efficiency posture of each scenario. The scorecard was developed in accordance with the Navy’s Three Pillar

approach and included nine categories of metrics and 22 individual Key Performance Indicators (KPIs) as shown in Figure 131.

The Energy Security and Readiness scorecard was used in conjunction with a range of additional performance metrics that the CEIP Vision Scenario Planning Tool generated. These metrics evaluated whether the scenario met each of the many energy mandates for reductions or renewable energy generation (Figure 132.), as well as cost performance metrics (Figure 133.). The interactive scenario building model allowed adjustments to various inputs such as project selection and implementation timeframes while simultaneously producing the various visual outputs for comparison. This process facilitated the fine-tuning and development of the scenarios.

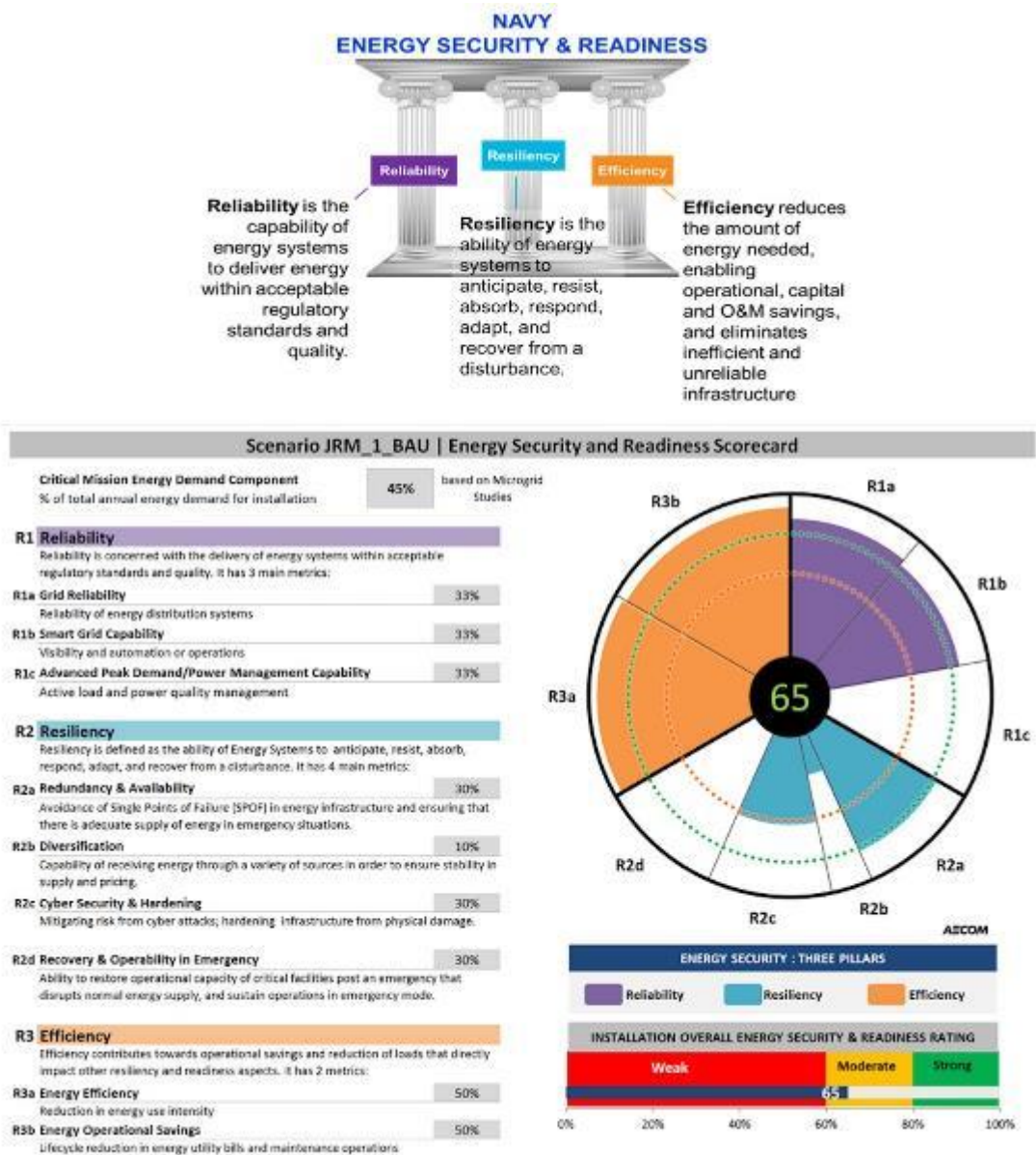

Figure 132. Energy security and readiness scorecard and criteria.

R1 Reliability Metrics	R2 Resiliency
Reliability is concerned with the delivery of energy systems within acceptable regulatory standards and quality. It has 3 criteria:	Resiliency is defined as the ability of Energy Systems to anticipate, resist, absorb, respond, adapt, and recover from a disturbance. It has 4 main criteria:
<b>R1a Grid Reliability (inside the Fence)</b>	<b>R2a Redundancy &amp; Availability</b>
R1a.1 SAIDI (Avg. Outage duration per Yr (minutes)) R1a.2 SAIFI (Avg. Interruption Freq. per yr) R1a.3 UEM Risk Rating (combination of CoF + LoF)	R2a.1 <b>Energy Supply</b> R2a.1.1 % Daily Energy Peak Capacity from on-site Renewable Energy sources R2a.1.2 % Daily Peak Energy Capacity from on-site emergency Generators
<b>R1b Smart Grid Capability</b>	R2a.2 <b>Redundant Infrastructure (Single Points of Failure)</b> R2a.3 <b>Other Availability Factors</b>
R1b.1 % of Installation integrated under Smart Grid R1b.2 % of facilities under AMI Metering R1b.3 Established Smart Grid communications network R1b.4 Energy Management (BAS & SCADA) capability R1b.5 Automation of power distribution system R1b.6 Integration of on-site generation capability	<b>R2b Diversification Metrics</b>
<b>R1c Advanced Peak Demand / Power Management Capability</b>	R2b.1 <b>Source Energy (Utility Grid) Diversity</b> R2b.2 <b>Site Energy Diversity</b>
R1c.1 Capability is available through Microgrid/SmartGrid R1c.2 % of Critical Mission Facilities with above capability	<b>R2c Energy Security &amp; Hardening Metrics</b>
<b>R3 Efficiency Metrics</b>	R2c.1 <b>Energy Cybersecurity</b> R2c.1.1 % of Energy SCADA Network on secure PSNET fiber R2c.1.2 % of Energy Microgrid on secure PSNET fiber
Efficiency contributes towards operational savings and reduction of loads that directly impact other resiliency and readiness aspects. It has 2 criteria:	R2c.2 <b>Physical Security on Critical Energy Assets</b> R2c.2.1 % Utility Transmission Underground R2c.2.2 % Utility Distribution Underground R2c.2.3 % Energy Comm Network Underground
R3a Energy Use Intensity Reduction R3b Utility Savings from Conservation+ Renewables and operational/ maintenance savings compared to No Action Projection	R2c.3 <b>Environmental Hardening/Protection</b>
	<b>R2d Recovery Metrics</b>
	R2d.1 <b>Islanding Capability</b> R2d.2 # of days capable of running in Island Mode R2d.3 % critical facilities with Tier-3/4 Emergency Generators R2d.4 % of daily energy load of energy storage* available (includes battery, thermal & other sources)

Figure 133. Cost performance metrics.

After the scenario development and exploration, a decision matrix was developed for the JRM leadership to facilitate selection of a recommended scenario and course of action. The matrix combined the projected resilience posture, energy mandate compliance, and the cost implications into a single table (Figure 134.). The referenced ‘Decision Matrix’ clearly showed that meeting energy mandates did not automatically translate to improved resilience and that substantial additional effort would be needed to achieve both resilience and energy conservation goals. Based on the evaluation, Scenario 3 (Resilient with Net-Zero at the new Marine Corps Base) was selected as the recommended scenario. A more detailed implementation plan with specific year-by-year project implementation plan was generated based on the selected scenario.

JRM Energy Scenarios		Energy Security and Resilience Scenario			EO 13800 Mandates*			DNIC Goal*			SECNAV Goal*			Cost Metrics		
Scenario Number	Scenario Description	Reliability	Resilience	Efficiency	Energy Security and Readiness Scorecard Snapshot	Energy Intensity Reduction - 20% by 2023	Electric Renewable Energy - 30% by 2025	Renewable Mandate - 27% by 2025	Energy Consumption Reduction - 30% by 2020	Energy from Alternative Sources - 30% by 2020	Net Zero (PFCNG Additional New) - 100% by 2030	Cost (\$M)	By 2035 (Process Will Save (\$M))	Cost (\$ / kWh Saved)	Payback	Payback
1	Business as Usual + Government Planned Projects	57	48	95		48%	84%	84%	28%	35%	28%	\$	\$	\$	16 Years (2029)	
2	Mandate Compliance	60	53	96		80%	100%	100%	28%	50%	40%	\$	\$	\$	18 Years (2028)	
3	Resilient with Net-Zero action	100	87	100		82%	133%	133%	28%	54%	42%	\$	\$	\$	17 Years (2032)	
4	Resilient Plus	100	90	100		85%	138%	138%	28%	55%	46%	\$	\$	\$	22 Years (2037)	

Notes:  
 Red Values indicate a Mandate or Goal is not being met.  
 Green Values indicate that a Mandate or Goal is being met or exceeded.  
 \*Performance against mandates or goals is reported to target year and covers the full evaluation period.

Legend:  
 0-50: Weak - needs improvement  
 60-70: Moderate - improved  
 80-100: Strong - approaching the extent of goal/mission  
 The Recommended Energy Scenario

Figure 134. Decision matrix.



#### 6.25.4 Lessons Learned

Feedback from the installation indicated that the outside assistance enabled a far more detailed and thorough assessment and plan that could have been possible without the extra help. The Directorate of Public Works (DPW) point of contact also felt they now have the data, tools, and knowledge to keep the plan current going forward. Although this result is to be expected, it also shows that the approach is manageable by the installation personnel. The level of detail will be less when the installation is required to complete the plan without outside assistance. Going forward, it is possible for other assessment teams to use the Assessment Guide and for the Army to move to a more standard method for assessing risk and prioritizing its investments based on risk.

The JRM CEIP Pilot was developed as a comprehensive framework to address the Navy's priorities for Reliability, Resilience, and Efficiency in a cost-effective way. The study highlighted a number of key lessons learned for the Guam situation in particular, but also for extending and adapting the process to other installations. These can be summarized as follows:

- *Resilience as Mission Assurance.* Guam has several environmental and mission requirements that drive the demand for resilient energy systems. While the mission assurance aspect resonates with all missions without exception, there is still apprehension about putting a cost on mission continuity. The concept of 'buying down risk' becomes an effective tool used in conjunction with scenario-based outcomes. For Guam, using the Energy Security and Readiness Scorecard to quantify the degree of resilience improvement proved effective in guiding decision-making.
- *Demand Reduction is Still Critical.* While improving and adding more resilient infrastructure (grid improvements, storage, microgrids etc.) are directly beneficial to improving resilience, it was clear from the CEIP scenarios that reducing the demand played a significant role in reducing the size of infrastructure improvements, the size of load to the island, and consequently the costs of resilience.
- *The Resilient Role of District Systems.* Within the context of Guam (and possibly other island systems), District Energy solutions prove to be highly favorable in improving resilience, provided they are carefully planned. The maintenance, flexibility, and future-readiness of district cooling and district microgrids connected to centralized generation and storage not only reduce long-term costs but add a layer of resilience and redundancy to the mission needs.
- *Blue-Sky Resilient Infrastructure.* Cost effectiveness of resilient energy systems comes from considering 'blue-sky' operations, i.e., by leveraging resilience infrastructure such as Battery Storage or onsite generation, not just during emergencies but on normal operational days.
- *Using Efficiency to Pay for Resilience.* It is important to integrate resilience into energy planning to maximize cost-effective opportunities. The cost avoidance from reducing demand and promoting efficiency in energy systems can provide much-needed funding for investing in resilience. This is particularly relevant for engaging third-party financing, which would need to bundle cost-saving conservation projects with cost-only infrastructure improvements to be financially viable. The JRM CEIP effectively identified potential project bundles that could engage public utility investment (GPA Solar projects with energy storage) and private investments through Energy Service Performance Contracts (ESPCs).

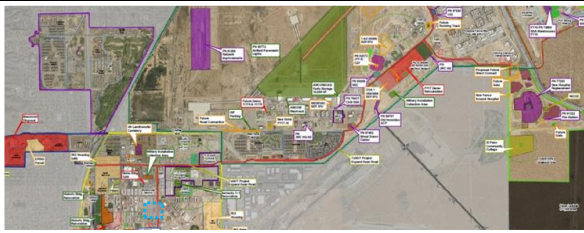
## 6.26 Military town Fort Bliss in Texas, USA

Case No.	Country	Location	Specific Type	Photo	Special points of attention
26	USA	Texas Fort Bliss	Campus Military Town		  renewable sources, critical infrastructure
This content is taken from Urban et al. (2020).					

### 6.26.1 Installation Background and Challenges

Fort Bliss, Texas, is the largest U.S. Army Forces Command (FORSCOM) installation and is home to multiple training and deployment missions. The installation is a Power Project Platform and Mobilization-Force Generation Installation (MFGI). Both of these designations indicate the critical role Fort Bliss plays in training, preparing, and mobilizing Armed Forces in response to National Security requirements. Commands stationed at Fort Bliss include the 1st Armored Division, 32nd Army Air and Missile Defense Command, the 11th Air Defense Artillery Brigade and Joint Task Force North. The installation provides anti-aircraft and missile defense capabilities and accommodates live fire exercises of nearly every type of Army weapon system. Fort Bliss includes 1.1M acres in western Texas and extends north into New Mexico to the border of White Sands Missile Range. The main cantonment is in El Paso, Texas. Fort Bliss is home to 39,000 military personnel and 39,000 family members and employs 13,000 civilians.

The planning process was initiated in April 2018 and the draft plan submitted in February 2019. Fort Bliss agreed to be a pilot site for the updated planning method and received technical support from Pacific Northwest National Laboratory and Concurrent Technologies Corporation through a contract with Office of the Deputy Assistant Secretary of the Army for Energy and Sustainability. At the time this case study was prepared, the installation DPW was just beginning the process of implementing Installation Energy and Water (IEWP) projects and management actions.

Drivers included the Assistant Secretary of Defense for Energy, Installations, and Environment memorandum dated March 31, 2016, and revised on May 30, 2018, requiring all DoD installations to develop Installation Energy Plans by September 2021. The Assistant Chief of Staff for Installation Management also released a memorandum on December 6, 2017 that required Army installations to develop Installation Energy and Water Plans, or IEWPs, that address both energy and water security and resilience to meet the Assistant Secretary of Defense requirement. A third driver that was instrumental in facilitating Fort Bliss staff and mission owner cooperation was the official order that the Garrison Commander signed and issued in support of this project, which required staff participation. Opponents in the process were limited, but there were barriers and challenges, with the main challenge discussed below.

### **6.26.1.1 Financing Challenges**

Army installations are constantly operating in a state of constrained resources. The solutions developed for the (Fort Bliss) IEWP needed to leverage existing Utility Privatization contracts, existing O&M budgets, military construction (MILCON), or potential third-party funding sources such as a recently awarded Utility Energy Savings Contract (UESC). The completed IEWP included a suggested funding approach for each Course of Action. The installation will need to prioritize based on existing needs and those provided by the IEWP to reduce risk. For instance, planned utility upgrades may be shifted to address distribution to certain facilities based on the results of the risk assessment. Larger projects sent to Headquarters, Department of the Army (HQDA) for competitive funding, such as the Resilience and Conservation Investment Program (ERCIP), will need to be supported by strong mission risk reduction and cost effectiveness data.

This project was unique in that it was funded as a pilot project by ODASA E&S. The purpose was to develop an Installation Energy and Water (E&W) security and resilience assessment approach for identifying recommended E&W solutions and documenting a solution implementation plan in an IEWP. Fort Bliss agreed to serve as the pilot installation for this effort. All Army installations are required to develop an IEWP by September 2021. ODASA E&S does not anticipate funding any additional IEWPs. Therefore, traditional funding channels will apply to the remaining Army installations. Likely, either the individual installations or their Commands will fund IEWPs leveraging O&M budgets. The majority of IEWPs due in September 2019 are underway via these funding channels.

### **6.26.1.2 Technical Challenges**

This project did not result in system designs; instead, it resulted in the development of a Fort Bliss IEWP to serve as a roadmap for achieving increased security, resilience, readiness, and mission assurance. The major challenge of assessment and plan design was developing an assessment process and plan that evaluated risk at both the installation-level and facility-level, which are both important considerations when evaluating the impacts of energy and water disruptions. The assessment process consisted of three risk assessment approaches with specific goals, which included: Critical Mission Sustainment (ensure that critical missions have the energy and water needed to sustain operations under any operating conditions), Critical Mission Risk Reduction (reduce risk of critical mission disruption from energy and water system deficiencies), and Installation Risk Reduction (reduce risk to all installation missions from energy and water disruptions and improve performance where lifecycle cost-effective).

Solution concepts were then developed in response to the high risks identified from each of the three risk assessment approaches. An additional challenge was integrating those solution concepts into one prioritized list of solutions based on risk reduction potential. Because the Army and the installation indicated that reducing risk to the MFGI mission was highest priority, this criteria was applied first when prioritizing solutions. Additionally, many solutions could reduce high risk identified in two or three of the risk assessment approaches, which also increased the solution priority.

To address areas of high risk identified in the risk assessments, a number of solution concepts were identified for energy and water generation, storage, and load management. Energy generation solutions identified include campus and building microgrids, substation centralized backup generators, gas turbine islanding, main substation generator islanding, and locomotive power. Water generation solutions include installing additional wells to



provide redundant water supplies. Energy storage solutions include adding energy storage to existing photovoltaics and adding onsite liquid natural gas storage. Water storage solutions include installing additional water storage at buildings with critical water needs. Energy and water load management solutions include building controls optimization, metering critical facilities, and ensuring appropriate cyber security controls on existing energy and water management systems.

### 6.26.2 Existing Infrastructure and Demand

All utilities on Fort Bliss are privatized. Electric utility service to the Fort Bliss main cantonment and ranges is provided by El Paso Electric (EPE). The main cantonment is served by five primary substations, which step down the 115-kV (1.2<sup>5</sup> V) EPE feeds to 13.2 kV (1.3<sup>4</sup> V) for local distribution on the Rio Grande Electric Cooperative (RGEC) wires.

Texas Gas Service supplies natural gas to Fort Bliss and owns and maintains the gas distribution system on the garrison. Texas Gas delivers natural gas to two primary regulator stations at the installation. The main pipeline supplies natural gas at pressures ranging between 300 and 375 psig (2068-2586 kpa). At the regulator stations, the pressure is reduced to pressures ranging from approximately 150–170 psig. Lower pressure distribution lines and service laterals (ranging from 15–60 psig, or 103-413 kpa) extend throughout Fort Bliss. Both the mains and distribution lines are stepped down via various other regulator stations located throughout the cantonment.

American States Utility Services, Inc., through its regulated subsidiary, Fort Bliss Water Services Company, owns, operates, and maintains the water and wastewater systems at Fort Bliss. The majority of the installation is supplied by a series of wells located on military property, and other portions of the installation are served via wholesale purchase from El Paso Water, an offsite water supplier. The water production, treatment, and distribution facilities consist of 16 active water production drinking water wells, nine booster stations, eight chlorination stations, 16 elevated storage tanks, 25 ground storage tanks, and approximately 370 miles (595 km) of water transmission and distribution mains. These water components comprise as many as 12 different waters systems and subsystems, some of which share water supplies and some of which do not.

Note that, while overall energy usage has increased, water conservation measures related to irrigation have caused a significant decrease in water usage over time. Costs have continued to rise for both energy and water. Tables 46 and 47 list general quantitative information.

**Table 46. Utility demand.**

	<b>Fort Bliss Site</b>	<b>Critical Facilities</b>
Electricity Demand (GWh)	322 (1.2 <sup>9</sup> MJ)	171 (6.2 <sup>8</sup> MJ)
Gas Demand (1000 Therms)	4,966 (5.2 <sup>5</sup> MJ)	1,409 (1.5 <sup>5</sup> MJ)
Water Demand (Mgal)	1,143 (4.3 L)	153 (0.6 L)
Building Area (ksf)	22,721 (1.1 <sup>6</sup> kpa)	10,144 (4.9 <sup>5</sup> kpa)

**Table 47. Rate schedule.**

<b>Utility</b>	<b>Average or Blended Rate</b>
El Paso Electric	\$0.056/kWh
Texas Gas	\$0.53/CCF*

Utility	Average or Blended Rate
New Mexico Gas	\$0.44/CCF
Fort Bliss Water Services Company: Water	\$1.94/kgal
Fort Bliss Water Services Company: Wastewater	\$2.537/kgal
El Paso Water: Water	\$1.58/kgal
El Paso Water: Wastewater	\$4.24/kgal
* CCF= Centum Cubic Feet [100 cu ft]	

The rate schedule includes demand billing as well as seasonal and time-of-use components. The rate structure also includes firm and interruptible components. The marginal rate, which includes interruptible demand and energy charges, is extremely low (2.6¢/kWh). As a result, there is little economic incentive to reduce energy consumption through efficiency. On the other hand, onsite dispatchable generation projects can result in significant savings through reduction of contracted firm demand.

### 6.26.3 Goals and Strategies

#### 6.26.3.1 IEWP Goals

- Ensure the ability of Fort Bliss to sustain critical missions in the event of an energy and/or water service disruption.
- Reduce the risk to all critical missions from energy and water (including wastewater) disruptions, with priority given to the MFGI mission.
- Reduce use of energy and water resources.
- Increase operational efficiency.

#### 6.26.3.2 IEWP Strategies

- Provide cost-effective alternatives to generators (e.g., storage, photovoltaics, demand response).
- Help to manage responses from the electric utility to reduce load under an interruptible tariff notice.
- Leverage alternative funding to support project implementation.
- Leverage Privatized Utility Capital Improvement Plan projects for smart modernization.
- Consider the O&M requirements of recommended solutions.

### 6.26.4 Highlight: Innovative Risk Assessment

The most innovative technical element of the Fort Bliss planning process was the risk assessment approach applied. Standard risk assessment approaches exist in the critical infrastructure risk management and mission assurance community. The intent was to mirror these approaches in a manner that was practical and feasible for support of the IEWP. One important goal of the development process was to ensure that the assessment method could be completed within reasonable level of effort by the installation staff themselves. The Army Headquarters proponents did not want to develop a process that would be entirely dependent on outside consultants and costly to support. It is understood that certain technical expertise will be required and necessary, but the optimal assessment method and guidance would be basic, repeatable, practical and as feasible as possible, while still

obtaining the desired results. ODASA E&S developed a risk assessment process that was practical given time and budget constraints and also do-able by the current installation staff (given the typical background, clearance and training the individuals would have).

The method piloted at Fort Bliss actually consisted of three risk assessment approaches with specific goals (Table 48.). The first step in this entire process is to identify and list all facilities that support critical missions as risk assessment approaches apply to different footprints. This is dependent on first identifying critical missions themselves and then the Critical Mission Footprint. To define the Critical Mission Footprint, the team reviews the installation’s real property list and identifies each facility and piece of infrastructure according to its criticality. Several sources of information were used to establish the initial Critical Mission Footprint:

- Critical infrastructure lists
- Facility Readiness Drivers (prioritizes poor and failing facilities)
- Risk assessments performed by personnel in the Directorate of Plans, Training, Mobilization and Security
- Coordination with emergency response personnel/plans
- Maps and diagrams showing energy and water infrastructure lines and locations
- Generator lists
- Mission-Essential Vulnerable Area list
- Real Property Master Plan.

The initial Critical Mission Footprint was refined with mission owner input. Further coordination with mission owners was conducted to complete mission decomposition and to determine which of the mission-essential functions and tasks support mission accomplishment. Mission decomposition considered all planned capabilities of the mission set (i.e., capability to meet troop surge requirements), not just baseline operations. The team then identified facilities and infrastructure that are necessary to support these functions located within the installation boundaries. The team also established dependencies on facilities and infrastructure across missions, as those that support multiple missions are considered more critical than others. Interview protocols were used to ensure that specific information needed for the risk assessment was collected during the data collection and site visit elements of the planning process.

**Table 48. Risk assessment approaches and goals for Fort Bliss.**

	<b>Critical Mission Sustainment</b>	<b>Critical Mission Risk Reduction</b>	<b>Installation Risk Reduction</b>
Goals	Ensure that critical missions have the energy and water needed to sustain operations under any operating conditions.	Reduce risk of critical mission disruption from energy and water system deficiencies.	Reduce risk to all installation missions from energy and water disruptions and improve performance where lifecycle cost-effective.

	<b>Critical Mission Sustainment</b>	<b>Critical Mission Risk Reduction</b>	<b>Installation Risk Reduction</b>
Assessment Approach	<ol style="list-style-type: none"> <li>1. Establish energy and water resource demand for critical mission sustainment.</li> <li>2. Establish baseline capability to meet Critical Mission Sustainment requirement (14 days or other).</li> <li>3. Identify opportunities to reduce resource demand.</li> <li>4. Generate and prioritize solutions to sustain missions (e.g., backup, storage, generation) and reduce demand.</li> </ol>	<ol style="list-style-type: none"> <li>1. Establish baseline condition of facility-level systems and procedures.</li> <li>2. Conduct detailed facility-level risk assessment.</li> <li>3. Identify opportunities to reduce resource demand.</li> <li>4. Generate and prioritize solutions to address critical facility and infrastructure deficiencies (e.g., lack of redundancy) and reduce demand.</li> </ol>	<ol style="list-style-type: none"> <li>1. Establish Installation Energy and Water resilience baseline and validate root causes (via Installation Status Report – Mission Capacity).</li> <li>2. Establish facility efficiency baseline.</li> <li>3. Identify opportunities to reduce resource demand.</li> <li>4. Generate solutions to reduce installation risk (e.g., exercises, plans) and improve facility efficiency.</li> </ol>

#### 6.26.4.1 Critical Mission Sustainment

The risk assessment for Critical Mission Sustainment quantified shortfall between energy and water needs and availability as provided by current solutions aimed at mitigating the impacts of disruptions. The risk assessment involves:

- Estimating energy and water needed for critical facilities and infrastructure
- Calculating duration each facility can be sustained with existing supplies of electricity, natural gas, water, and fuel
- Calculating energy and water needed by each facility to meet Critical Mission Sustainment requirement (i.e., 14 days or other documented by the mission)
- Calculating the shortfall
- Analyzing opportunities to address the gap through:
  - Energy load/use analysis and reduction potential via whole-building modeling and building controls optimization
  - Water conservation assessment tools
  - Onsite backup and storage sizing and capacity analysis
  - Onsite renewable energy/alternative water production feasibility tools
- Calculating contribution of solutions toward Critical Mission Sustainment requirement
- Estimating costs/benefits.

#### 6.26.4.2 Critical Mission Risk Reduction

The risk assessment for Critical Mission Risk Reduction involves scoring facilities with a Mission Impact Index. Scoring of risk at the facility-level is necessary to identify critical missions vulnerable to energy and water disruption and to prioritize solutions to reduce this risk. Risk is based on the presence of deficiencies in the supporting utility systems and the mission sensitivity to energy and water disruptions. A deficiency is a flaw affecting the integrity of an infrastructure that, when compromised, causes the degradation or failure of a critical mission. The Mission Impact Index scores facilities using a qualitative scale adapted from standard risk assessment approaches (Figure 135.). The “score” is qualitative and the only math used is addition to keep the scores as “buckets” for comparison with other facilities, creating a “1 ton” list. The results document facilities, deficiencies and risk score

and are considered sensitive material. The assessment team members had the appropriate level of clearance to analyze these data and brief the installation.

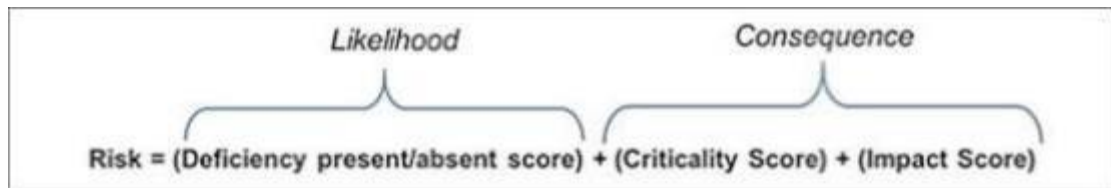

Figure 135. Mission impact index.

### 6.26.4.3 Installation Risk Reduction

The risk assessment for Installation Risk Reduction aims to define potential projects and best management practices (BMPs) that would reduce overall risk and improve operational efficiency. Installation Risk Reduction solutions include those that address deficiencies in access to energy or water, the overall condition of energy and water infrastructure, and installation-level operations and planning. Solutions will also include those that reduce energy and/or water demand in facilities across the installation. Installation Risk Reduction is based on the installation's energy and water security posture as measured by Installation Status Report – Mission Capacity scores. Data collected and validated through onsite interviews, supporting documentation review, and inspection of systems was used to adjust these scores and identify areas where risk reduction measures are needed.

### 6.26.5 Decision and Design Process

Fort Bliss has access to energy and natural gas. There is also solar power potential. The installation has onsite capability to generate power through limited solar panels and an onsite natural gas turbine. Fort Bliss is uniquely situated over a freshwater aquifer and has its own onsite water wells. Potable water is constrained in this region due to lack of surface freshwater. The aquifer is fresh with saltwater intrusion that must be carefully managed to meet future water demand. Climate change adds additional stress to the aquifer as surface water will become less available and demand will continue to increase.

At the time this case study was prepared, the installation DPW was just beginning the process of implementing IEWP projects and management actions, so the single most crucial parameter for go/no-go decisions had not yet been established. The installation did express concerns about constrained resources and funding availability for new energy and water projects in addition to other projects they were also trying to implement, suggesting that project cost and funding availability are high on the list of parameters for funding decisions. There are a number of other criteria that Army installations apply go/no-go decisions on energy and water projects, including those identified by the IEWP. The criteria considered when prioritizing projects for implementation include: Contribution to Risk Reduction, Operational Efficiency, and/or Energy and Water Demand Reduction; Availability of Funding Options; Change in O&M Burden; Project Implementation Feasibility.

### 6.26.6 Resilience

Each Task outlined in the IEWP is designed to increase resilience of Fort Bliss to prevent, prepare for, and respond to future energy and water disruptions. Energy and water resilience is defined by four attributes: (1) Critical Mission Sustainment – ability to reduce risk to critical

missions by being capable of providing necessary energy and water for a minimum of 14 days; (2) Assured Access – availability to redundant and diverse sources of supply, including renewable energy and alternative water, that meet evolving mission requirements during normal and emergency response operations; (3) Infrastructure Condition – access to infrastructure capable of onsite energy and water storage along with flexible and redundant distribution networks that reliably meet mission requirements; and, (4) System Operation – availability of trained personnel who conduct required system planning, operations, and sustainment activities for energy and water security. The Army uses an annual data call, titled Installation Status Report – Mission Capacity, to assess the energy and water resilience posture of its installations (Table 49.). The data call is structured around these four attributes. The measures provide the basis for assessment of current resilience posture as well as the impact of the IEWP on improving the resilience into the future.

**Table 49. Example installation status report.**

<b>Task #</b>	<b>Task Title</b>	<b>Responsible Party</b>	<b>Funding Type</b>
<b>1</b>	<b><i>Enhance Operations and Plans</i></b>		
1.1	Establish Generator Refueling Plans	DPW-Electric	O&M Budget
1.2	Ensure Cyber Security of Utility Control Systems	DPW-Electric/Water/Gas	O&M Budget and UP* Contract
1.3	Augment Deployable Backup Power Systems	DPW-Electric	O&M Budget and UP Contract
1.4	Prepare Emergency Response Plans and Conduct Readiness Training Exercises	DPW-Electric/Water/Gas	O&M Budget and UP Contract
<b>2</b>	<b><i>Improve Infrastructure Condition</i></b>		
2.1	Improve Electric System Infrastructure	RGEC/Fort Bliss Water	UP Contract, ERCIP or SRM**
2.2	Improve Water System Infrastructure	Fort Bliss Water Services Company	UP Contract
2.3	Leverage substation project to enhance capacity		O&M Budget, UP Contract or SRM
2.4	Install water storage or air-cooled HVAC in critical facilities with cooling towers		O&M Budget or SRM
<b>3</b>	<b><i>Increase Capacity</i></b>		
3.1	Investigate Utility Scale EPE Asset	DPW-Electric/EPE	O&M Budget or Power Purchase Agreement
3.2	Implement Campus-Scale Microgrid	DPW-Electric	O&M Budget, UP Contract, UESC or ERCIP
3.3	Install Substation Centralized Backup Generators	RGEC	UP Contract or ERCIP
<b>4</b>	<b><i>Reduce Demand</i></b>		
4.1	Meter Critical Facilities	DPW-Electric/Water/Gas	O&M Budget, UP Contract, or SRM
4.2	Install and Optimize Building Controls	DPW-Electric	O&M Budget or UESC
4.3	Implement Energy Conservation Projects	DPW-Electric/Gas/Water	O&M Budget or UESC
4.4	Implement Water Assessment and Conservation Projects	DPW-Water	O&M Budget or UESC
* UP = Utilities Privatization			
**SRM = Facilities Sustainment, Restoration and Modernization (SRM) program.			

### **6.26.7 Lessons Learned**

The project team found that the single greatest barrier and challenge in completing the assessment and plan development was lack of available data to conduct risk analyses to the required level of detail. It was very challenging to obtain data from the privatized utility contractors that own and operate the installation's utilities. For example, one-line drawings of the power system serving the installation could not be obtained from the privatized electrical system owner; therefore, redundancy of installation circuits could not be evaluated.

Interaction with the mission owners at Fort Bliss made an important contribution to the success of the planning process. This interaction provided the basis for the list of critical missions and inputs into the risk assessment. It was also important for providing a basis for proactive interaction between mission owners and installation DPW going forward.





#### **6.26.7.1 Major Bottlenecks**

Two major bottlenecks were experienced. First, privatization of utilities creates a bottleneck for access to system information. Non-disclosure agreements were needed and, even after that, some information important for risk assessment was not available. Proxies were used, but this limited the ability to prioritize deficiencies effectively as many facilities scored similarly in the analysis. The second bottleneck was scheduling and conducting interviews. This process takes some time. Especially for an installation the size of Fort Bliss, the team needs to account for identifying the correct individuals, accommodating their schedules, and performing follow-up if the information requested is not available on the first attempt.

### **6.26.8 Major Lessons Learned**

- Provide cost-effective alternatives to generators (e.g., storage, photovoltaics, demand response).
- Help to manage responses from the electric utility to reduce load under an interruptible tariff notice.
- Leverage alternative funding to support project implementation.
- Leverage Privatized Utility Capital Improvement Plan projects for smart modernization.
- Consider the O&M requirements of recommended solutions.
- Prepare for generation and management of Classified information.
- Many solutions to reduce risk are operations-based and low cost.
- Strategies to manage the number of critical missions (and associated facilities) may be needed.

## 6.27 Denver National Western Center in Denver, Colorado

Case No.	Country	Location	Specific Type	Photo	Special points of attention
27	USA	Denver National Western Center	Campus		   heat pump, district heating, renewable sources



<b>Country:</b>	USA
<b>Name of city/municipality/public community:</b>	Denver National Western Center in Denver, Colorado
<b>Title of case study:</b>	Energy Planning for the Denver National Western Center Redevelopment and Modernization
<b>Author name(s):</b>	Tony Tubiolo, Marcy Loughran
<b>Author email(s):</b>	tony.tubiolo@ee.doe.gov, Marcy.Loughran@denvergov.org,
<b>Link(s) to further project related information/publications, etc.:</b>	
<b>City of Denver website about the National Western Center</b> <a href="https://www.denvergov.org/content/denvergov/en/north-denver-cornerstone-collaborative/national-western-center.html">https://www.denvergov.org/content/denvergov/en/north-denver-cornerstone-collaborative/national-western-center.html</a>	
<b>National Western Center webpages:</b>	
<b>Campus energy</b> <a href="https://nationalwesterncenter.com/about/what-is-the-nwc/data-hub/year/campus-energy/">https://nationalwesterncenter.com/about/what-is-the-nwc/data-hub/year/campus-energy/</a>	
<b>The Redevelopment Process</b> <a href="https://nationalwesterncenter.com/about/the-redevelopment-process/">https://nationalwesterncenter.com/about/the-redevelopment-process/</a>	
<b>Design and Construction</b> <a href="https://nationalwesterncenter.com/design-and-construction/">https://nationalwesterncenter.com/design-and-construction/</a>	
<b>Master Plan for the National Western Center redevelopment, March 9, 2015:</b> <a href="https://nationalwesterncenter.com/about/the-redevelopment-process/master-plan/">https://nationalwesterncenter.com/about/the-redevelopment-process/master-plan/</a>	
Page 36 contains the guiding principle stating the net zero campus goal: EER 3: Create “net zero” or “closed loop” systems for energy, waste, and water EER 3.1: Create a “net zero” energy district, prioritizing technical and behavioral strategies to increase efficiency and using on-site renewable energy sources (by 5 years after full build-out).	
<b>Sewer Heat Recovery (SHR) Screening Analysis in Section 4 of the Delgany Interceptor and South Platte River Study Alternatives Analysis report, June 28, 2017, by AECOM:</b> <a href="https://nationalwesterncenter.com/nwc-wp/wp-content/uploads/2017/11/Delgany-Alternatives-Analysis-Report_6-28-2017-FINAL.pdf">https://nationalwesterncenter.com/nwc-wp/wp-content/uploads/2017/11/Delgany-Alternatives-Analysis-Report_6-28-2017-FINAL.pdf</a>	
<ul style="list-style-type: none"> <li>• Estimates total heating and cooling capacity available at the site through sewer heat recovery (in MWt and MMBTU/hr)</li> <li>• Estimates heating demand and cooling demand for each building, according to the project phases (in kWh/yr)</li> <li>• Estimates the needed SHR heating and cooling system size (in MW) for the campus</li> <li>• Provides a set of screening criteria for analysing SHR options in more detail.</li> <li>• Identifies sewer heat recovery as a source of up to 70% of the campus heating and cooling demands.</li> </ul>	
<b>Energy Action Plan Technical Advisory Report, October 2017, by Xcel Partners in Energy program</b> <a href="https://nationalwesterncenter.com/nwc-wp/wp-content/uploads/2017/11/NWC-Energy-Action-Plan.pdf">https://nationalwesterncenter.com/nwc-wp/wp-content/uploads/2017/11/NWC-Energy-Action-Plan.pdf</a>	
<ul style="list-style-type: none"> <li>• Highlights the collaboration and support from local regulated electric utility company</li> <li>• Identifies sewer heat recovery as source of up to 55% of the campus energy requirements</li> <li>• Identifies that construction to best-in-class standards could limit the increase in energy of entire campus to only 10% more than current buildings on site, even though the new campus will be four times larger.</li> </ul>	
<b>Letter of support and commitment from local energy utility company, April 23, 2018</b> <a href="https://nationalwesterncenter.com/nwc-wp/wp-content/uploads/2018/04/Xcel-National-Western-Center-letter-04232018.pdf">https://nationalwesterncenter.com/nwc-wp/wp-content/uploads/2018/04/Xcel-National-Western-Center-letter-04232018.pdf</a>	
<b>Request for Qualifications (RFQ) for campus energy partner</b>	
<b>Campus Energy RFQ Supporting Documentation, April 25, 2018:</b> <a href="https://nationalwesterncenter.com/nwc-wp/wp-content/uploads/2018/04/NWC-Campus-Energy-Concept-Design-for-Procurement-April-2018.pdf">https://nationalwesterncenter.com/nwc-wp/wp-content/uploads/2018/04/NWC-Campus-Energy-Concept-Design-for-Procurement-April-2018.pdf</a>	
(This document provides the estimated energy demand by building and campus-wide, including cooling and heating demand, electricity and natural gas demand, conceptual piping plan and heating/cooling systems schematic diagrams, and solar photovoltaic net metering analysis results.)	
<b>RFQ Announcement, May 4, 2018:</b> <a href="https://nationalwesterncenter.com/mayors-office-of-the-national-western-center-begins-journey-to-creating-net-zero-energy-campus/">https://nationalwesterncenter.com/mayors-office-of-the-national-western-center-begins-journey-to-creating-net-zero-energy-campus/</a>	
<b>Announcement of campus energy partner, September 20, 2018:</b> <a href="https://nationalwesterncenter.com/press-release-mayors-office-of-the-national-western-center-announces-energy-partner/">https://nationalwesterncenter.com/press-release-mayors-office-of-the-national-western-center-announces-energy-partner/</a>	

## 6.27.1 Background and Framework

The National Western Center has a history that goes back to the beginning of the 20<sup>th</sup> century, where it has served as the location for an annual livestock show of regional and

national significance. It spans an area of approximately 250 acres in the northern part of Denver, Colorado (USA) (see Tables 50 and 51).

A collaborative process of redevelopment planning was launched in 2013 in response to the stock show's need to replace outdated facilities and have opportunity for future growth, and to keep the stock show in Denver rather than relocating to new facilities in another community. The master planning process has been led by the commitment of staff and resources from the City & County of Denver, Mayor's Office of the National Western Center. Regional and state partners involved in the master planning process include the Western Stock Show Association, Colorado State University, the Denver Museum of Nature & Science, and History Colorado.

The redevelopment will include large-scale event venues allowing the campus to host an expected 2.2 million visitors per year. The campus will offer educational, entertainment, and cultural programming events. Visitors will be able to learn first-hand about the clean energy and energy efficiency features at the site (see Figure 136).

### **6.27.2 Energy Objectives**

The partners in the master planning process created nine guiding principles for the redevelopment. One of the guiding principles is "Embrace an Ethic of Regeneration (EER)." Within the details for this guiding principle can be found the following statements about energy (on page 36 of the National Western Center Master Plan):

- EER 2: Design and operate facilities to maximize efficiency of facilities and resources per user.
- EER 3: Create "net-zero" or "closed loop" systems for energy, waste, and water.
- EER 3.1: Create a "net-zero" energy district, prioritizing technical and behavioral strategies to increase efficiency and using onsite renewable energy sources (by 5 years after full build-out).
- EER 3.2: Create a "net-zero" or "closed loop" district for waste streams and apply relevant techniques and training during operations (by 5 years after full build-out).
- EER 3.3: Create a "net-zero" district for water use, use zero potable water for landscaping, and apply relevant techniques and training during operations (by 5 years after full build-out).

Figure 137 shows the components of energy demand and supply for the National Western Center.

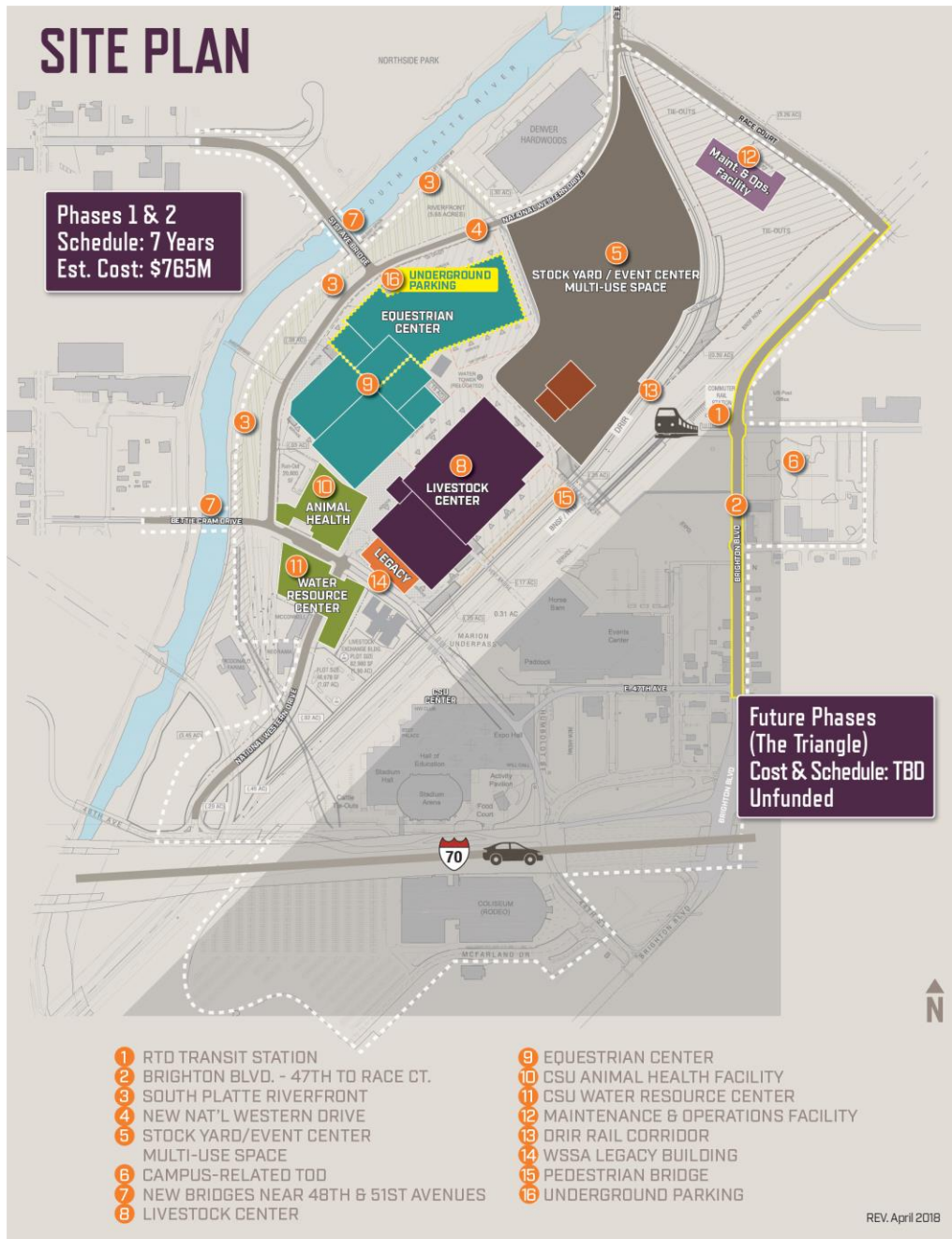
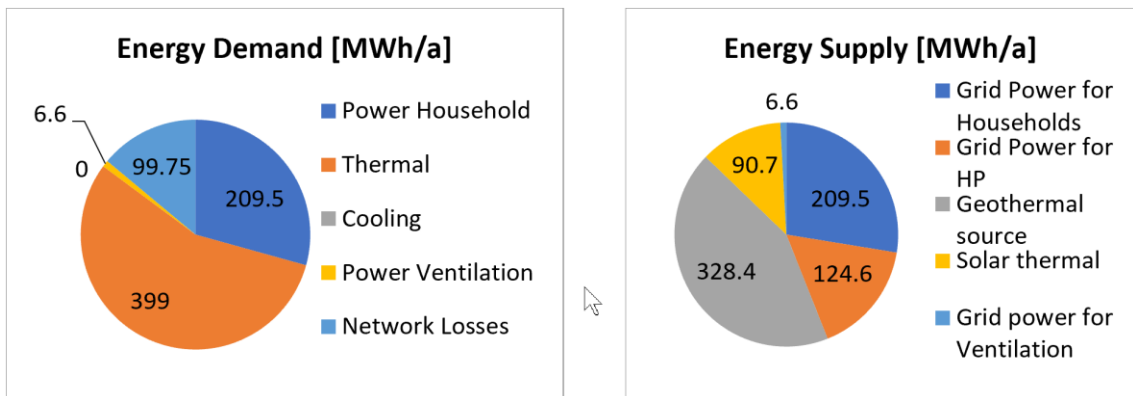

Figure 136. Site plan of the National Western Center.

**Table 50. General quantitative information about Generation, Storage, and Consumption of Energy in Denver National Western Center. “After” energy demand and energy yield estimates are taken from the June 28, 2018 “NWC Campus Energy Concept RFP Supporting Information for Procurement Only,” which is not publicly available. “Before” estimates are from AECOM’s sewer heat recovery screening analysis in the “Delgany Interceptor and South Platte River Study Alternatives Analysis” report, June 28, 2017.**

	Urban scale of area [m <sup>2</sup> ]	Total gross floor area [m <sup>2</sup> ]	Heated floor area [m <sup>2</sup> ]	Population/Users in the area	Thermal energy demand [MWh/a]	Network heat losses [%]	Heating grid trench length [m]	Number of consumer substations; heat	Number of producer substations; heat	Supply/return T [°C]	Thermal energy storage volume [m <sup>3</sup> ]	Annual heat yield from local sources [MWh/a]	Cooling energy demand [MWh/a]	Electrical energy demand	Annual electric energy yield [MWh/a]
Before	250 acres	700,000 sf				—	0	0	0	—	0			5,100,000 kWh	
After	250 acres	2,215,765 sf	1,344,565 sf		50,177 kBtu/hr		4880 feet	7	0	58 °F heating, 74 °F cooling			31,548 kBtu/hr	14,331,597 kWh	13,890,019 kWh (AC)



**Figure 137. Pie chart showing the components of energy demand and supply.**

**Table 51. Additional information on building mix and energy supply concept.**

<b>Building mix in the area*:</b>	It will be a mix of industrial and non-residential (livestock yards, livestock barns, animal health clinic, equestrian center, event centers, parking structures, office space, exhibit space, education space, maintenance facility)
<b>Consumer mix in the area**:</b>	Large consumers (over 800 MWh/year) represent 94% of the estimated annual energy consumption.
<b>Energy plant owner (public or private):</b>	Private; EAS Energy Partners (a consortium of Enwave USA Holdings, AECOM Technical Services, and Saunders Construction).
Four key elements will be included in the campus energy system:	
1. A sewer heat recovery system with campus ambient two-pipe loop and central utility plant.	
2. Distributed HVAC systems in each building (water cooled electric heat pumps).	
3. Campus solar photovoltaics (PV) located on each building rooftop and within the campus.	
4. Energy storage and/or biofuel generators (gensets) used for campus load management and demand response.	
Sewer Heat Recovery could supply 70% of the campus heating and cooling demand, making a large contribution toward the net zero energy campus goal. (Delgany Interceptor and South Platte River Study Alternatives Analysis, June 2017, by AECOM)	
Thermal energy supply technologies***:	Sewer Heat Recovery, Electric Heat Pumps
Electric power supply technologies:	Rooftop photovoltaics

### 6.27.3 Technical Highlight

The extraordinary technical highlight of this project is the development of a campus energy system that uses sewer heat recovery. A private entity, EAS Energy Partners, will design, build, finance, and operate the campus energy system for the National Western Center. The sewer heat recovery system, housed in a central utility plant, will use a set of heat exchangers to transfer heat between the sewer main and the ambient campus distribution piping loop. In winter, the campus energy system will extract heat from the sewer for heating, and in summer it will collect waste heat from cooling. The ambient campus distribution loop will have a supply pipe and a return pipe connected to each building. Each building will have a water-cooled electric heat pump that uses the pre-conditioned water from the campus distribution loop. Sewer heat recovery will be able to supply 70% of the heating and cooling demand of the campus, according to an analysis by AECOM.

### 6.27.4 Main Innovative Approach

**A main innovative approach** of this project is how the City of Denver conducted a rigorous master planning and community stakeholder engagement process, and is implementing key aspects of that process through horizontal development of the site. (The site is owned by the City of Denver.) The City launched the process of identifying a campus energy approach through a Request for Information (RFI) in 2017. Then, after the National Western Center Authority was established in 2018 as the tenant and operator of the National Western Center, the Authority took the lead on the RFP process to select and procure the long-term services of a campus energy partner.

The community stakeholder engagement process was initiated in 2013 and informed the development of the National Western Center Master Plan (published March 2015). Elements of the community stakeholder engagement process included:

- Establishment of a 21-person Citizens Advisory Committee for the National Western Center
- Four public meetings - held in conjunction with project milestones, to gather community input on development of the master plan
- Outreach meetings at recreation centers – to share the master plan recommendations
- Office hours on the project site – to allow community members to stop in and ask questions.

The Citizens Advisory Committee was established in 2013 to allow residents and businesses in the surrounding neighborhoods to help shape the vision and goals for the redevelopment. Twenty-one members of the community were chosen through an application and selection process to serve on the Committee. Citizens Advisory Committee members participated in monthly meetings with the project partners, and participated in focused breakout sessions to discuss and provide input on specific elements of the master plan. Importantly, the Citizens Advisory Committee will continue to provide input —throughout the design, construction and operational phases of the project— as an ongoing method for community stakeholder engagement.

Coordination with planning processes for the surrounding neighborhoods was a priority. The National Western Center Citizens Advisory Committee, city staff, and project team management participated in meetings for the neighborhood planning processes of the two neighborhoods adjacent to the project site. This ensured coordination and consistency between the adjacent neighborhood planning efforts and the project site (Figure 138).

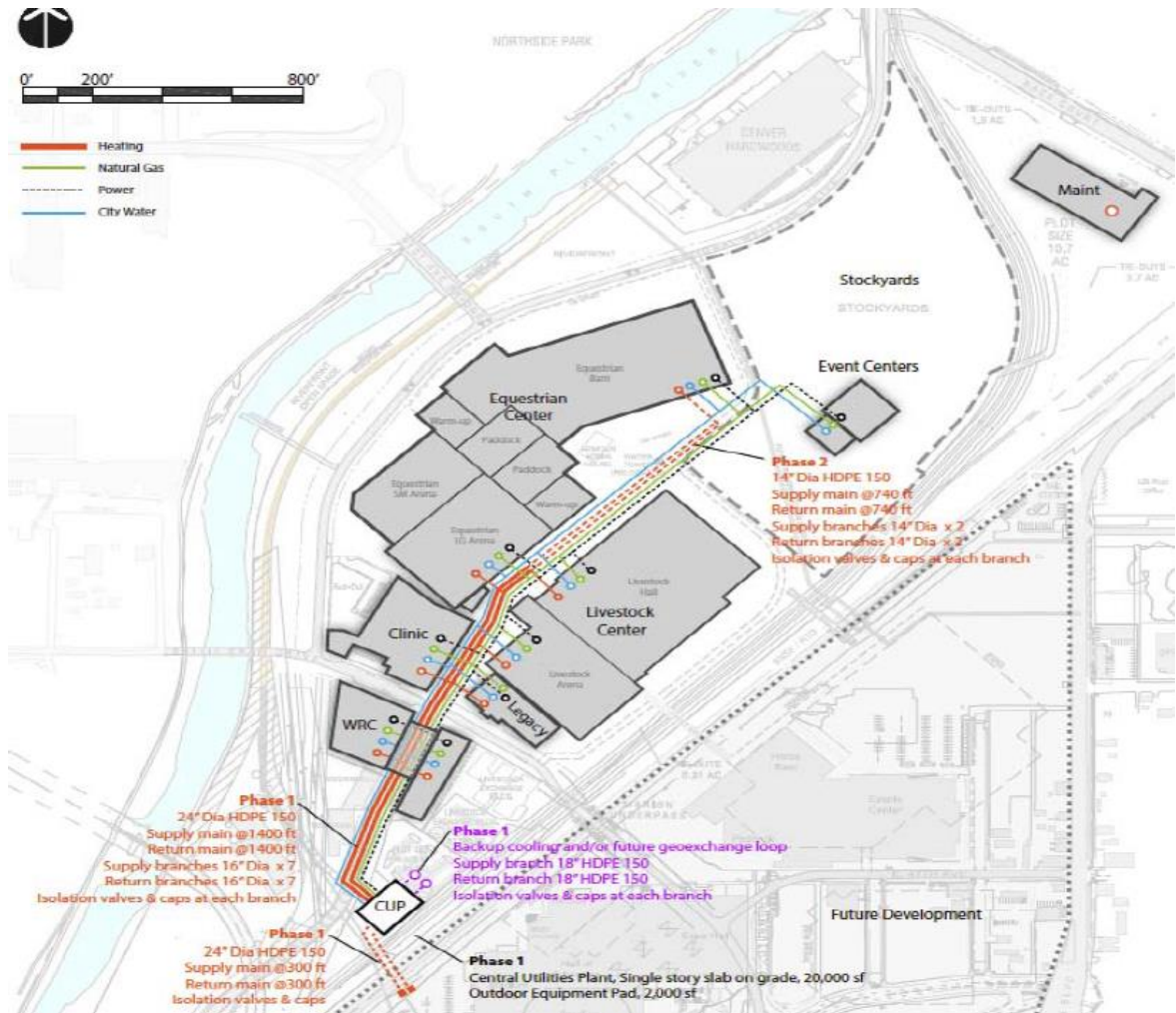

Figure 138. Energy system as planned for Denver National Western Center.

## 6.27.5 Design and Planning Process

### 6.27.5.1 General/Organizational Issues

Why was this project initiated, to answer which need?

*This project was initiated in response to the need for the Western Stock Show Association to obtain modernized and expanded facilities for their events at the site.*

Which stakeholders were involved in the project?

- *Local government:* City & County of Denver, Mayor's Office of the National Western Center
- *Project end user:* Western Stock Show Association
- *Local university and project end user:* Colorado State University
- *Local museum:* Denver Museum of Nature & Science
- *Local utility company:* Xcel Energy
- *Local wastewater treatment provider:* Metro Wastewater Reclamation District
- *Local clean drinking water utility:* Denver Water
- *State historic preservation office:* History Colorado
- *Federal agency/laboratory:* U.S Department of Energy, National Renewable Energy Laboratory (NREL)

Which resources were available before the project? What are local energy potentials?

*A sewer main pipeline for the City of Denver, which runs through the campus. Sewer heat recovery has the potential to satisfy 70% of the heating and cooling demands of the campus.*

Who (what) were drivers and who (what) were opponents (barriers) – and why?

*The City of Denver was a driver for the redevelopment project in two ways. Economic development was a driving factor for the redevelopment of the site, and Denver’s environmental goals were a driver for establishing the campus net-zero goals. The City had already established a goal of reducing greenhouse gas (GHG) emissions 80% below 2005 levels by 2050. For an urban redevelopment project like the National Western Center to work within the context of the City’s GHG goals, this project simply had to have aggressive energy efficiency and renewable energy goals, which ultimately became the net-zero energy goal for the National Western Center campus.*

### **6.27.6 Financing Issues**

What have been the main challenges/constraints regarding financing?

*The city and the authority did not have capital funds available to construct a campus energy system at the site. Therefore, the city chose to issue an RFI “to identify potential partnership approaches involving experienced energy investment partners who are able and qualified to deliver a campus-wide energy (thermal and electric) program to the National Western Center Authority.”*

Which business model applies to the project?

*The land is owned by the City of Denver, and most of the new buildings that will be built will also be owned by the City.*

*The private sector campus energy partner will design, build, install, finance, own, operate and maintain the campus energy systems (thermal and electric) at the National Western Center. The campus energy partner will be repaid over time through utility bills, during a long-term operating agreement.*

### **6.27.7 Technical Issues**

What solutions have been considered for generation, storage and load management?

1. *A central utility plant with heat exchangers for sewer heat recovery*
2. *A campus ambient distribution loop for circulating the water from the central utility plant*
3. *Individual electric heat pumps and air handling systems at each building*
4. *Rooftop photovoltaics.*

#### **6.27.7.1 Design Approach Applied**

Which design targets have been set and why?

*The target for the campus is annual net-zero energy performance – the campus will highly use energy efficient facilities and renewable energy generation – on an annual basis the campus energy consumption and generation will be balanced.*





## 6.27.8 Lessons Learned

### 6.27.8.1 Major Success Factors

- Ownership of the project site by the city and county of Denver – This allows both the vision/master plan and the redevelopment to be overseen, and partly implemented, by the same entity.
- Community stakeholder engagement – The robust community stakeholder engagement process has worked to incorporate the best stakeholder ideas and address concerns voiced by the community.
- Electric utility company partnership and collaboration – The local electric utility company (Xcel Energy) has supported the redevelopment planning efforts with all the resources it has available within its energy utility regulatory environment. Xcel Energy’s letter of commitment on April 23, 2018 lists many of the ways they will continue to support the site redevelopment.
- Iterative energy studies to explore all possible energy efficiency and renewable energy opportunities, followed by an RFI to obtain technical and market insight by potential campus energy implementation providers.

## 6.28 Developing Ford District in St. Paul Minnesota, USA

Case No.	Country	Location	Type Specific Type	Photo	Special Points of Attention
28	USA	St. Paul	Campus New District		  <p>solar energy, thermal storage</p>

Country:	USA
Name of city/municipality/public community:	Saint Paul, Minnesota, Ford Site
Title of case study:	Planned Redevelopment of the Ford Site in Saint Paul, Minnesota into a 21st Century Community
Author name(s):	Tony Tubiolo, Sarah Zaleski, Mike Richardson, Menaka Mohan
<b>Link(s) to further project related information/publications, etc.:</b>	
<b>City of Saint Paul website for the Ford Site Planning Process:</b>	
<a href="https://www.stpaul.gov/departments/planning-economic-development/planning/ford-site-21st-century-community">https://www.stpaul.gov/departments/planning-economic-development/planning/ford-site-21st-century-community</a> <a href="https://www.stpaul.gov/sites/default/files/Media%20Root/Planning%26%20Economic%20Development/Ford-Site-Master-Plan.pdf">Ford Site Zoning and Public Realm Master Plan, adopted by the Saint Paul City Council on September 27, 2017. https://www.stpaul.gov/sites/default/files/Media Root/Planning%26 Economic Development/Ford-Site-Master-Plan.pdf</a>	
<b>Project Energy Studies:</b>	
<a href="https://www.stpaul.gov/sites/default/files/Media%20Root/Planning%20%26%20Economic%20Development/FINAL%20UE%20-%20St.%20Paul%20Ford%20Site%20ATES%20Study%20-%20Aug%202016.pdf">Aquifer Thermal Energy Storage (ATES) Feasibility Study (2016)</a> <a href="https://www.stpaul.gov/sites/default/files/Media%20Root/Planning%20%26%20Economic%20Development/NREL%20Report%20-%20Ford%20Site%20Solar%20Potential%20-%20March%202015.pdf">Integration of Rooftop Photovoltaic Systems in Saint Paul Ford Site's Redevelopment Plans (2016)</a> <a href="https://www.stpaul.gov/sites/default/files/Media%20Root/Planning%20%26%20Economic%20Development/Ford%20Site%20Energy%20Study%20Report%20-%20FINAL%20and%20Appendices%2012-4-15.pdf">NREL%20Report%20-%20Ford%20Site%20Solar%20Potential%20-%20March%202015.pdf</a> <a href="https://www.stpaul.gov/sites/default/files/Media%20Root/Planning%20%26%20Economic%20Development/Ford%20Site%20Energy%20Study%20Report%20-%20FINAL%20and%20Appendices%2012-4-15.pdf">Saint Paul Ford Site Energy Study Report (2015)</a> <a href="https://www.stpaul.gov/sites/default/files/Media%20Root/Planning%20%26%20Economic%20Development/Ford%20Site%20Energy%20Study%20Report%20-%20FINAL%20and%20Appendices%2012-4-15.pdf">https://www.stpaul.gov/sites/default/files/Media%20Root/Planning%20%26%20Economic%20Development/Ford%20Site%20Energy%20Study%20Report%20-%20FINAL%20and%20Appendices%2012-4-15.pdf</a>	
<b>Other Project Studies (Sustainability):</b>	
<ul style="list-style-type: none"> <li>• Sustainable Ford Site Redevelopment – A LEED-ND Evaluation (2016)</li> <li>• The Roadmap to Sustainability for the Saint Paul Ford Site (2011)</li> </ul>	

### 6.28.1 Ford Site: A 21st Century Community

This 122 acre site (Figure 139) sits along the Mississippi River in Saint Paul, Minnesota. It was the location of Ford's Twin Cities Assembly Plant from 1925-2011, a facility originally powered with hydroelectric power from the river. At peak employment, there were 2,100 employees working there. In 2006 the Ford Company announced that it would close the facility. The City of Saint Paul began the master planning for redevelopment of the site, and the master planning process continued for over a decade. Ford completed demolition of the assembly plant and environmental remediation on the site and in June of 2018, Ryan Companies of Minneapolis, MN was awarded the contract to become the master developer to purchase and develop the site. While Ryan Companies has begun infrastructure construction, it is expected that development will occur in phases and take 12-20 years for complete build-out of the entire site.

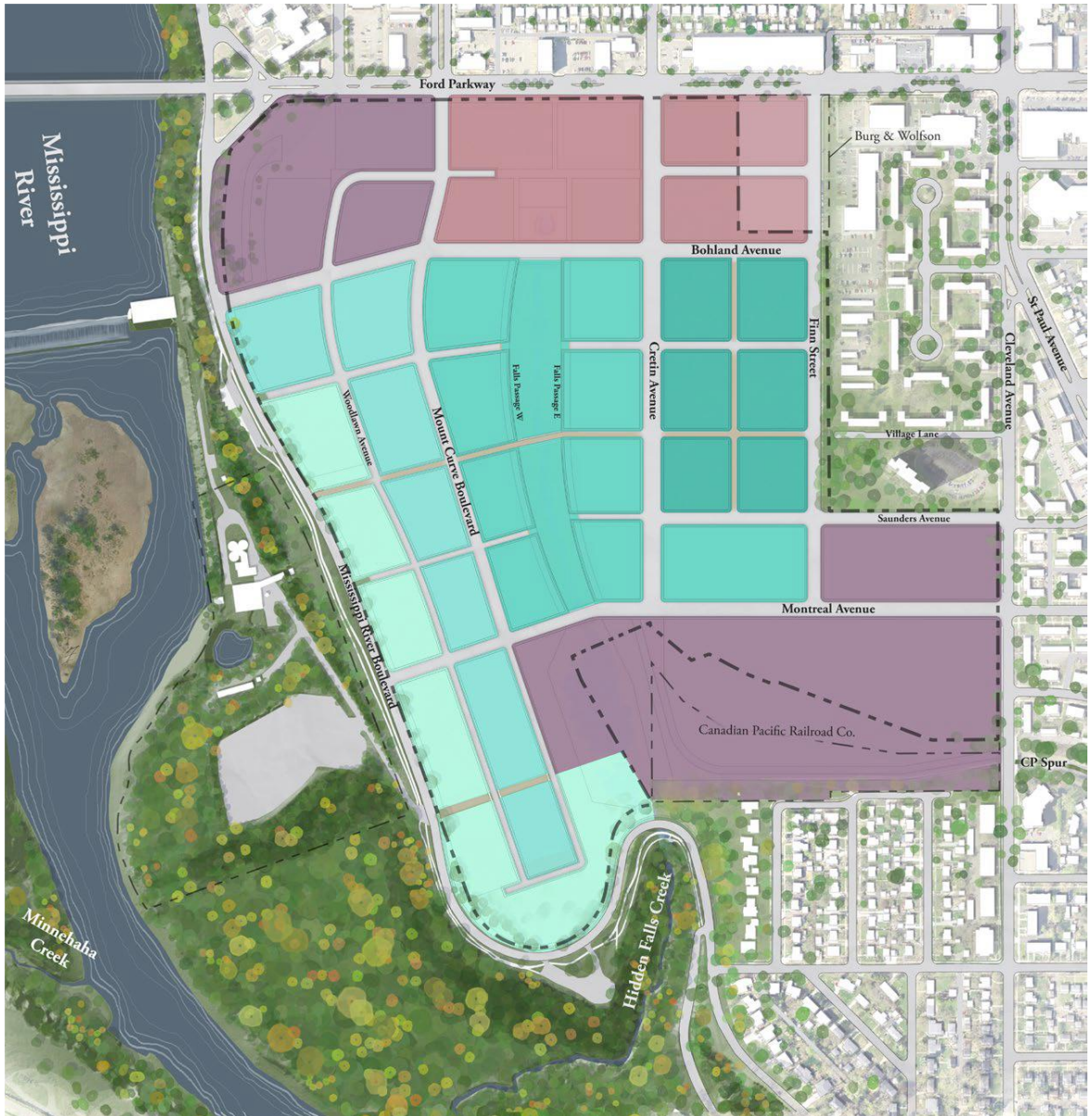

**ZONING DISTRICTS**

- River Residential (48' Max)
- Residential Mixed Low (55' Max)
- Residential Mixed Mid (65' or 75' Max)<sup>1</sup>
- Residential Mixed High (75' or 110' Max)<sup>2</sup>
- Business Mixed (75' Max)
- Gateway (65' Max)

**Figure 139. Map of the zoning districts for the Ford Site.**

The goal is for this former industrial site to become a livable, mixed-use neighborhood with job opportunities and sustainable features, including infrastructure for walking, bicycling, and transit.

To accomplish this, the city has rezoned the site into six mixed-use districts: Four of the zoning districts are primarily multifamily residential, one zoning district is primarily for businesses, and the sixth mixed-use zone will provide two gateways into the site. Over 50 acres of the site will be accessible to the public, not only by using traditional rights-of-way, but also by using a

robust mix of parks, privately-owned public space, and ped-bike corridors. This zoning will result in up to 1,500 jobs returning to the site, and up to 4,000 residential units.

### **6.28.2 Energy Planning**

Out of 14 project studies that have been conducted for the Ford Site (see Table 52), three are energy studies:

1. Aquifer Thermal Energy Storage (ATES) Feasibility Study (2016)
2. Integration of Rooftop Photovoltaic Systems in Saint Paul Ford Site's Redevelopment Plans (2016)
3. Saint Paul Ford Site Energy Study Report (2015).

The Ford Site will have all new utilities as it is redeveloped, and the intent is to consider the energy system from a site-wide scale with cutting edge technologies. The city and local utilities led an effort to examine feasibility and options and will presented the developer with a recommended plan for the energy system.

Energy Goals, from the 2015 Saint Paul Ford Site Energy Study Report:

- Resilience: Security of energy supply
- Innovation: Rethinking energy supply and energy systems not being limited by current practices
- Net-Zero: Minimizing energy consumption and CO<sub>2</sub> emissions while maximizing the share of renewable energy
- Energy efficient: Making best use of energy with low conversion and distribution losses and efficient building stock
- Cost effectiveness: Ensuring affordable energy for the site.

The last three goals were used in the financial analysis conducted on the options in the Energy Study Report.

These goals are included in the Energy and Sustainability Guiding Principles of the Ford Site Master Plan, which was adopted by the City Council in September 2017. As adopted, the site goals are stated as:

- Locally generated power from an integrated, renewable, site-based energy system
- Best technologies in infrastructure and buildings to save money, increase efficiency, and reduce impacts on the environment.

**Table 52. Quantitative Information on Ford Site.**

Planned Building mix in the area:*	
Residential:	3,800 dwelling units
Non-Residential:	415,000 square feet
Retail & Service:	33-37%
Office & Employment:	50%
Civic & Institutional:	12-17%
Two primary sources of energy production were under consideration:	
District heating and cooling using aquifer thermal energy storage (ATES)	
Rooftop solar photovoltaic (PV) was considered, but not implemented. Power from the hydroelectric dam next to the site will be used, and 1MW array on an adjacent parcel	
Annual Total Heat Demand (Simulated)	Annual Total Cooling Demand (Simulated)
47,503 MMBtu/yr	26,616 MMBtu/yr
13,922 MWh/yr	7,507 MWh/yr

### 6.28.3 Technical Highlight

**The technical success during planning** was the series of 14 planning studies conducted, including three energy studies. The initial energy study report was funded through a foundation grant, and enabled an energy consultant team to evaluate onsite energy system options for the site. That initial energy study report identified ATES and rooftop solar PV as the two main forms of renewable energy that warranted additional detailed feasibility studies. These detailed studies were then conducted the following year, with further grant funding from the U.S. Environmental Protection Agency (USEPA), to further refine the technical and financial feasibility for these energy technologies.

**The non-technical planning success** was the dedication of time and effort the City of Saint Paul planning department put into extensive community stakeholder engagement from 2007 through 2017. This stakeholder engagement effort was visible and reached the community through:

- Over 80 presentations to business, civic and non-profit groups
- 45 public meetings with over 1300 people attending those meetings
- Over 100 articles in print, radio and television media.

Thousands of ideas and comments were received through this engagement effort, and the key themes from the community were able to be incorporated into the vision statement and six guiding principles that were ultimately adopted by the City Council and Mayor as the Ford Site Zoning and Public Realm Master Plan. The new vision for the site, rather than the existing industrial use, was available to developers as they made bids on the site.

### 6.28.4 Design and Planning Process

#### 6.28.4.1 General/Organizational Issues

Why was this project initiated, to answer which need?

*This project was initiated because of the unprecedented opportunity for site redevelopment that came from Ford's decision to vacate and sell the property. The City of Saint Paul recognized the opportunity and put serious effort into looking at all possible site use opportunities and assessing how to maximize the benefits to the City through the redevelopment.*

Which stakeholders were involved in the project?

*Practically every stakeholder in the region was involved.*

Which resources were available before the project? What are local energy potentials?

*Local expertise and experience with the downtown district energy system.*

Who (what) were drivers and who (what) were opponents (barriers) – and why?

*The mayor and other city leaders were proponents for thoughtful redevelopment that would maximize benefits of the site redevelopment to the community.*

What was finally the crucial parameter for go /no-go decision?

*The site would be vacated and sold by Ford no matter what, so that created an automatic “go” decision.*

#### **6.28.4.2 Financing Issues**

What have been the main challenges/constraints regarding financing?

*It has been difficult to accurately model and design the system with only a master plan in place because of the inherent flexibility found therein. Without an accurate model, ownership, or utility structure in place, it is difficult to get too far in developing a financing plan.*

Which business model applies to the project?

*The master developer, Ryan Companies, has purchased and begun developing the site infrastructure. Some individual parcels will be developed by Ryan Companies, but others will be sold and developed by others.*

#### **6.28.4.3 Technical Issues**

What solutions have been considered for generation, storage and load management?

*Aquifer thermal energy storage and rooftop solar PV have been considered for energy storage and generation.*

Which design targets have been set and why?

*Buildings in the Ford Site development will be expected to follow the requirements of the Saint Paul Sustainable Building Policy:*

*[https://library.municode.com/mn/st.\\_paul/codes/code\\_of\\_ordinances?nodeId=PTIIIADCO\\_TI\\_TIVPOPR\\_CH81SUBU](https://library.municode.com/mn/st._paul/codes/code_of_ordinances?nodeId=PTIIIADCO_TI_TIVPOPR_CH81SUBU). Embedded in the Saint Paul Sustainable Building Policy is the requirement to meet the energy requirements of the Minnesota Sustainable Building 2030 (SB 2030) Energy Standards for new buildings, which is similar to the Architecture 2030 Challenge goals. <http://www.b3mn.org/2030energystandard/overview-2/>*

*The requirement, as stated on the Minnesota SB 2030 website:*

*Every five years, the total energy use in buildings is to be reduced starting in 2010 at 60% and ending in 2030 as a 100% reduction (**net-zero carbon**). The benchmark for these reductions in the national program is the energy use of the average building in 2003 found in the federal Commercial Buildings Energy Consumption Survey (CBECS) database.*

- 2010 – 60% reduction in carbon producing fuel used for building energy.
- 2015 – 70% reduction in carbon producing fuel used for building energy.

- 2020 – 80% reduction in carbon producing fuel used for building energy.
- 2025 – 90% reduction in carbon producing fuel used for building energy.
- 2030 – 100% reduction in carbon producing fuel used for building energy.”

*This pertains to site energy (not source energy) and Minnesota has developed an SB 2030 Energy Standard Tool, which can translate this to the site EUI target in kBtu/square foot/year for a building being designed.*

Which decision steps/workflow lead to the retained solution?

*The City of Saint Paul had a citywide sustainable building policy in effect that was easily applied to the Ford Site.*

## **6.28.5 Lessons Learned**

### **6.28.5.1 Major Success Factors**

See the section “Description of a technical highlight/innovative approach” for details on two success factors. An additional success factor was the strong support from the Mayor, City Council, and the Ford Company for actively creating a new vision for the future of the site. Related to this was a staff commitment from the city that has lasted for more than a decade and buy-in from a master developer that believed in the vision.

### **6.28.5.2 Major Bottlenecks**

Operationally, the planning effort was led by staff in the Department of Planning and Economic Development. However, much of the adopted master plan was informed by other departments in the city, and while they were responsive, the complicated nature of the project elevated the potential for progress to get held up.

### **6.28.5.3 Major Lessons Learned**

Although an ambitious new vision was created for the site, there was uncertainty whether a new developer who would purchase and develop the site would find it feasible to implement all the ideas and concepts laid out during the City-led visioning for the site within the timeframe needed for horizontal and vertical development to proceed. Therefore, it was uncertain whether a district heating and cooling system with ATES could actually happen. While the city conducted a significant amount of study to ascertain the financial and technical feasibility of a district energy system, more focus could have been placed on implementation frameworks (structure of utility agreements, final user cost and method of payment, etc.) to better prepare for the period between identification of a developer and execution of a development agreement.

What should be transferred from this project?

*City staff can lead a process of active community engagement and act as a hub for all city departments to create a shared vision that optimizes community benefits from the redevelopment of a property. As the city works through early project phases with the developer, staff are developing a better understanding of how to define expectations and policy in advance of projects being initiated. The city is also considering how the lessons learned from large district projects can be translated to smaller, parcel-scale projects.*

## 6.29 University Campus in Austin, USA

Case No.	Country	Location	Specific Type	Photo	Special points of attention
29	USA	Austin	Campus University		  district energy system, critical infrastructure
<b>Country:</b>		United States of America			
<b>Name of city/municipality/public community:</b>		Austin, Texas			
<b>Title of case study:</b>		"Supporting A Fast Track Mission-Critical Campus Healthcare Expansion at The University of Texas Austin"			
<b>Author name(s):</b>		Laxmi Rao, Juan Ontiveros			
<b>Author email(s):</b>		<a href="mailto:laxmi.idea@districtenergy.org">laxmi.idea@districtenergy.org</a> ; <a href="mailto:juan.ontiveros@austin.utexas.edu">juan.ontiveros@austin.utexas.edu</a>			
<b>Link(s) to further project related information/publications, etc.:</b>					
The University of Texas at Austin Medical District Master Plan, Spring 2013. <a href="https://campusplanning.utexas.edu/masterplan/documents/MedicalDistrict20130509.pdf">https://campusplanning.utexas.edu/masterplan/documents/MedicalDistrict20130509.pdf</a>					
Juan Ontiveros, "Supporting A Fast Track Mission-Critical Campus Healthcare Expansion The University of Texas at Austin." 2013.					
University of Texas Austin, Natural Resource Conservation Plan. April 9, 2012. <a href="https://sustainability.utexas.edu/sites/sustainability.utexas.edu/files/NaturalResourceConservationPlan_Spring2014_ProgressReport.pdf">https://sustainability.utexas.edu/sites/sustainability.utexas.edu/files/NaturalResourceConservationPlan_Spring2014_ProgressReport.pdf</a>					
Joshua Rhodes, "Texas Electric Grid Sets New System-Wide All-Time Peak Demand Record, Twice." Forbes. November 16, 2018. <a href="https://www.forbes.com/sites/joshuarhodes/2018/07/19/texas-electric-grid-sets-new-system-wide-all-time-peak-demand-record-twice/#d200d2815212">https://www.forbes.com/sites/joshuarhodes/2018/07/19/texas-electric-grid-sets-new-system-wide-all-time-peak-demand-record-twice/#d200d2815212</a>					
USEPA. eGRID Summary Tables. 2016. <a href="https://www.epa.gov/energy/egrid-summary-tables">https://www.epa.gov/energy/egrid-summary-tables</a>					
Jeff Easton and Juan Ontiveros, "Thermal Energy System Expansion for the Dell Medical District University of Texas at Austin." CampusEnergy2015. IDEA, 2015. <a href="https://www.districtenergy.org/viewdocument/large-thermal-energy-systems-expans">https://www.districtenergy.org/viewdocument/large-thermal-energy-systems-expans</a>					
Jeff Easton, "Rethinking Efficiency: UT Austin takes a creative approach to unprecedented campus growth." District Energy Magazine, Quarter 1, 2016. <a href="http://www.districtenergy-digital.org/districtenergy/2016Q1?pg=16#pg16">http://www.districtenergy-digital.org/districtenergy/2016Q1?pg=16#pg16</a>					
Danielle Pieranunzi, "SITES and LEED: Meeting a high bar for built and natural systems." <i>The Sustainable SITES Initiative</i> . January 17, 2018. <a href="http://www.sustainablesites.org/sites-and-leed-meeting-high-bar-built-and-natural-systems">http://www.sustainablesites.org/sites-and-leed-meeting-high-bar-built-and-natural-systems</a>					

### 6.29.1 Background and Framework

#### 6.29.1.1 Medical District Master Plan

The University of Texas at Austin Medical District Master Plan envisioned the expansion of a new Medical District on the southwestern edge of the University of Texas in downtown Austin, including a new medical school, medical research building, teaching hospital, and medical office building (MOB) and the supporting district energy systems to provide heating, cooling, and electricity to the Medical District (figures 140-142). The UT Austin Medical District master plan was phased over time. Phase 1 included the education and administration building, research building, MOB Phase 1, Parking Structure, teaching hospital, and potential chilling station. Phase 2 is to be completed in the next 5-10 years will be the final build-out for the Medical District could include Academic and Research buildings, parking structures, and future housing as needed.





Figure 140. Chilled-water and heating water connections for the Medical District (Phase 1) at the University of Texas Austin and close up of new chilling station and thermal energy storage (TES) tank (Source: University of Texas Austin 2015).



Figure 141. Chilled water and heating connections for the Graduate School of Business and the Engineering, Education and Research Buildings at the University of Texas Austin. This connection is via direct connection to the Main Campus looped chilled-water and steam tunnel distribution system.

Phase I Buildings	Gross Square Feet
<b>Medical School Phase I</b>	
Education and Administration Building	114,634
Research Building	289,701
Medical Office Building	244,214
Parking Garage	325,000
<b>Plus New Main Campus Buildings</b>	
Engineering Education and Research Building	454,422
Graduate School of Business	318,779
<b>Phase I Total Gross Square Feet</b>	<b>1,744,650</b>
<b>Phase II Buildings For Medical District</b>	
UI Academic	268,550
UT Research	168,000
UT Research	255,550
Academic	310,000
Parking Garage	300,000
<b>Phase II Total Gross Square Feet</b>	<b>1,311,100</b>

Figure 142. Project parameters of the University of Texas Austin divided into phases.

### **6.29.1.2 Utility Master Plan**

The Utility Master Plan was designed and developed in 3 months to support the fast track mission-critical expansion of the Medical District included in the phases envisioned in the Medical District Master Plan. A design-build project delivery method was used to expedite the project and allow budget flexibility through an open-book approach. The Utility Master Plan included both the 943,449 new square feet from Phase 1 and the build-out of 1.3 million square feet for Phase 2. The annual consumption, peak energy requirements, and water needs were estimated by analyzing the building type and actual metered energy use per gross square foot (GSF) for existing campus buildings. The plant's total capacity and rate impact was determined from this analysis. The Termis software tool chilled-water and steam model was used to size and plan the distribution system.<sup>2</sup> The Utility Master Plan investigated the following:

- New chilling station design criteria
  - Thw capacity & efficiency required to prevent negative impact to campus
  - Need to continue philosophy of chilled-water loops and redundant service
  - Need to be expandable to address subsequent phases of the Medical District.
- It was important to also consider new space, in addition to Phases 1& 2, added to the main campus (not in the Medical District) that included the construction of a Graduate School of Business and Energy Engineering Resource Building. Including these two buildings added a total of 801,201 GSF to the chilled-water system. All told Phase I added 1,744,650 GSF to the chilled-water system.
- Avoid power plant expansion
- Avoid conflict between Peak Steam and Peak Power.

### **6.29.2 Objectives and Attainment**

In November 2017, the 14-acre Dell Medical District at The University of Texas Austin became the first project to hold SITES, LEED, and PEER certifications, making it one of the most holistically sustainable and resilient facilities in the world.<sup>8</sup>

#### **6.29.2.1 Energy & Water Objectives**

In April 2012, the Natural Resources Conservation Plan outlined several energy and water objectives at the University of Texas Austin regarding reliable and efficient energy systems, demand side energy efficiency, alternative generation, and water conservation.<sup>3</sup>

### **6.29.2.2 Reliable and Efficient Energy System**

Campus Planning and Facilities Management (CPFM) will maintain utility system performance at, or above its current level of reliability and annual average plant efficiency of about 88%, average electrical generation performance of about 8,500 BTU/kWh and chilling station performance at approximately 0.70 kW/ton. CPFM will also continue to anticipate changes in campus demand and plan to meet these new requirements using existing equipment and systems, avoiding additional major capital investment, to the extent possible.

### **6.29.2.3 Demand Side Energy Efficiency**

By August 31, 2020, the University of Texas Austin will reduce energy consumption at the building level by an average of 20% per square foot per degree-day, using 2009 as the base year. Accomplishing this goal will require an investment in energy management staffing, centralized building energy control systems, conservation and efficiency projects, and a specific resource reduction goal for each building. Achieving this goal will produce three specific benefits:

1. Avoided energy costs (estimated at \$4M annually)
2. Reduction in the campus carbon footprint (approximately 40,000 metric tons CO<sub>2</sub>e)
3. Ability to allow the utility operation to maintain its current level of efficiency (a 1% loss of efficiency costs \$300,000/year).

### **6.29.2.4 Alternative Generation**

By August 31, 2020, 5% (just over 17M KWH) of all energy consumed by UT Austin facilities on the Main Campus, will be generated from renewable sources. Renewable energy sources include solar, wind, waste management, biomass, wood burning, small hydro and other carbon neutral sources. Achieving this goal will reduce the UT Austin carbon footprint by an estimated 6,000 MTCO<sub>2</sub>e but may have a negative impact on overall cost reductions given the high cost and low efficiency of alternative generation compared to UT Austin's own current generation.

### **6.29.2.5 Water Conservation**

By August 31, 2020, UT Austin will reduce domestic water use by 20% with at least 40% of total water use coming from reuse/reclaimed sources. Based on projected increases in water and wastewater costs, meeting this goal will produce annual avoided costs in excess of \$2M annually. In addition achieving this goal will reduce the city of Austin's carbon footprint by at least 460 tons CO<sub>2</sub> equivalent. As of FY2014, this goal was met by avoiding 21% of water consumption by managing domestic water, irrigation upgrades, use of reclaimed water and water recovery strategies.

Other energy and water leadership objectives include:

- Offset campus space growth and related energy plant growth envisioned in the campus master plan.
- Demonstrate leadership in renewable energy investments.
- Demonstrate leadership in utility, irrigation and building consumption.

- Continue investment in high performance buildings.

### 6.29.3 Energy Market Context

The United States has three independent power grids, one of which, the Electric Reliability Council of Texas (ERCOT), serves most of Texas. ERCOT is the independent system operator for the region and schedules power on the electric grid. It is an energy-only market, meaning that power plants are only compensated if they provide power (or ancillary services) to the market.

At the start of 2018, ERCOT’s capacity mix was 53% natural gas, 21% coal, 20%wind, 5% nuclear, and 2% from other sources. Recent retirements of coal plants have shifted the capacity mix, resulting in more wind capacity than coal capacity. Low natural gas prices has primarily kept wholesale market prices low, which has made coal generators non-profitable. The large amount of renewable energy, mainly wind, has also contributed to the low wholesale market prices.<sup>4</sup>

#### 6.29.3.1 Energy Factors

Table 53 lists the total output emission rates and non-baseload output emission rates for ERCOT according to eGRID2016.<sup>5</sup>

**Table 53. Total output emission rates and non-baseload output emission rates for ERCOT.**

	<b>Total output emission rates (kg/MWh)</b>	<b>Non-baseload output emission rates (lb/MWh)</b>
CO <sub>2</sub>	457	635

UT Austin operates a 134 MW CHP and microgrid system to provide 100% of the campus’s electricity, including the Medical District, versus relying on power from the ERCOT grid. It also provides thermal utilities in the form of steam, hot water, and chilled water. As of 2017, after the completion of Phase 1 of the Medical District Expansion, the campus-wide efficiency factors were

- 36.8% Gas turbine electric efficiency
- COP 5.097 for Chilling Stations
- 83.20% Overall Efficiency to Campus
- kBtu/sq ft/year for heating at Medical District (Table 54).

**Table 54. Parameters according to building type, heating, cooling and electricity.**

<b>Building Type</b>	<b>Heating kBtu/sq ft/year</b>	<b>Cooling kBtu/sq ft/year</b>	<b>Electricity kBtu/sq ft/year</b>
Office - Administration	0.034	0.096	0.028
Hospital	0.209	0.167	NA
Research	0.198	0.098	0.028
Medical Offices	0.338	0.229	0.049

#### **Chilled Water, Electricity and Heat Supply**

The new Chiller Station No 7. provides 15,000 tons of chilled-water capacity to the Medical District using six, 2,500 ton chillers and a 5 °F approach cooling tower. The chilled-water capacity is expandable to 20,000 tons. A 5,500,000 gallon TEST provides more than 5 MW load shifting

capacity. A new hot water system provides heating water for the Medical District. At the Chiller Station No 7, there are heat pump chiller and watertube boilers to provide 53,000 MBH of heating hot water capacity. The Hot Water Plant No. 1 provides 40,000 MBH of heating hot water via steam-to-hot-water exchangers. The existing 134 MW CHP plant at UT Austin provides the electricity for the Medical District.

The UT Austin Medical District Phase 1 was built from scratch including the heating and cooling systems. Before and business as usual would follow the same standards as for the UT Austin campus (Table 55).

The cooling supply temperature varies based on the outside temperature (i.e., warmer in winter and colder in summer). The cooling return averages a 13 °F temperature difference,  $\Delta T$ , for the year. The return temperature varies from 52 °F to 55 °F (Tables 56 and 57).

**Table 55. General Information on UT Austin campus.**

	Urban scale of area [acres]	Total gross floor area [m <sup>2</sup> ]	Heated floor area [m <sup>2</sup> ]	in the area (occupancy numbers for the
Before	22.12	15,071	15,071	25
BAU	22.12	15,071	15,071	25
After	22.12	2,261,650	2,261,650	100

**Table 56. Quantitative information on energy distribution, storage and demand.**

	Heating network losses [%]	Cooling network losses [%]	Heating grid trench length [miles]	Cooling grid trench length [miles]	Number of consumer substations; heat	Number of producer substations; heat	Heating Supply Temperature [°F]	Heating Return Temperature [°F]	Cooling Supply Temperature [°F]	Cooling Return Temperature [°F]	TES volume [gallons]	Thermal energy demand – heating [kBtu/yr]	Cooling energy demand [MWh/a]	Electrical energy demand [kWh/year]	Annual electric energy yield [MWh/a]
Before	20	5	0.5	0.5	0	0					3,900,000	3,903,994	8,187,766	3,140,803	341,870
BAU	20	5	0.5	0.5	0	0					3,900,000	3,903,994	8,187,766	3,140,803	341,870
After	10	5	1.51	1.5	4	4	155	130	3-4	52-55	5,500,000	56,453,169	178,645,765	22,077,072	341,870

**Table 57. Additional Information on energy system of UT Austin.**

<b>Additional information:</b>	
<b>Building mix in the area*:</b>	
Office, Hospital, Research (Medical District)	
Consumer mix in the area**:	Large >800 MWh/year
Energy plant owner (public or private):	Public
Insert additional information that is relevant for this project. The list below is only an example	
<b>Thermal energy supply technologies***:</b>	
Chillers	6 @ 2,500 tons each, 4.16K Volt Electric w/ VFD's
Heat Pump Chiller	600 ton, Electric
Hot Water Boilers	37 MMBtu, Natural Gas
<b>Steam-to-hot water heat exchangers:</b>	
Thermal energy storage:	5,500,000 gallons / 52,000 ton hours
Investment costs****:	\$89.5 million
Cooling energy used:	14,887,147 ton hours
Available cooling power:	131,400,000 ton hours
Electrical energy demand:	22,077 MWH
Voltage level:	12,000
N. of consumer substations:	4
Electric power supply technologies:	CHP, 134 MW, Natural Gas
Annual electric energy yield:	341,870 MWH
Backup power, critical demand:	74 MW from reserve generators and 25 MW from utility stand-by

### 6.29.4 Technical Highlight

Technical highlights include the savings (Figure 143) associated with the Energy system architecture of UT Austin Medical District (Figure 144).



**Figure 143. The heat pump chiller saves \$287,000 per year in gas savings and 17 million gallons per year in water savings.<sup>6</sup>**

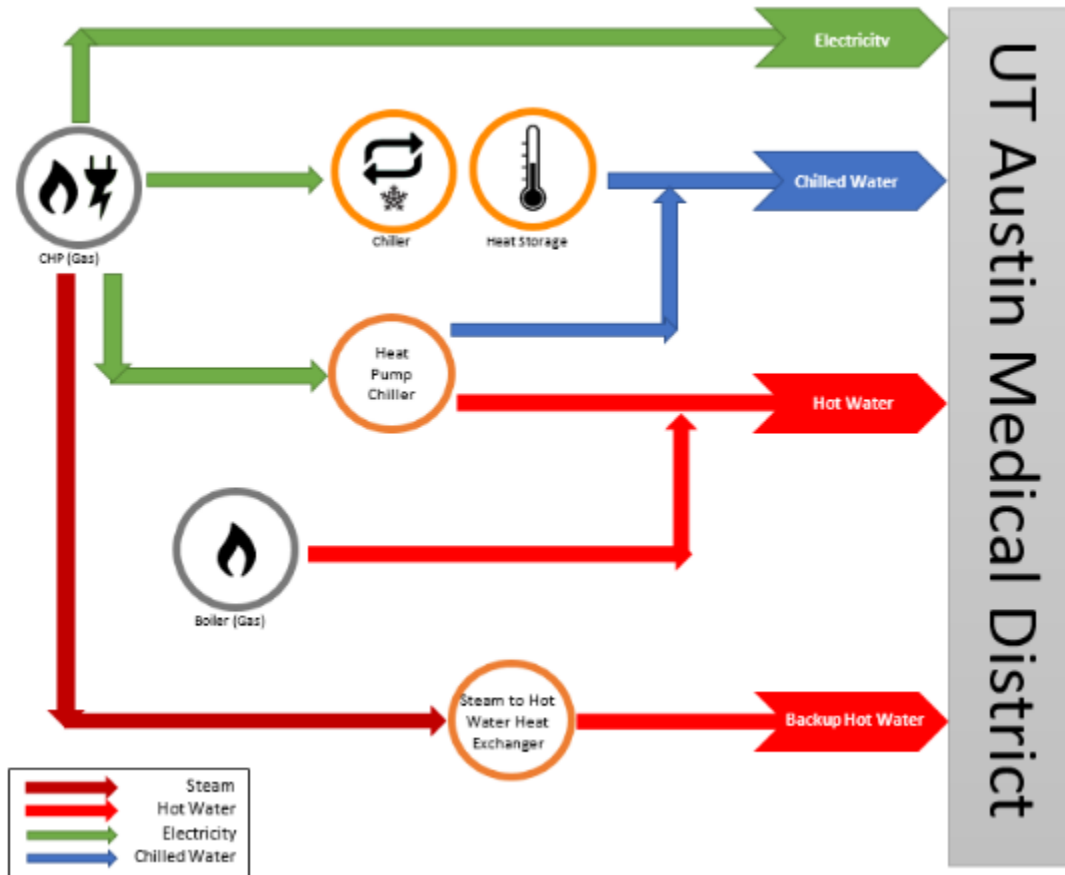

Figure 144. Energy system architecture of UT Austin Medical District.

## 6.29.5 Design and Planning Process

### 6.29.5.1 General/Organizational Issues

Why was this project initiated, to answer which need?

*This project was initiated to provide heating, cooling, and electricity to the Medical District expansion.*

Which stakeholders were involved in the project?

*UT Austin, Seton Healthcare, Central Texas Healthcare, Flintco, and Burns & McDonnell were stakeholders involved in the project.*

Which resources were available before the project? What are local energy potentials?

*A 134 MW CHP system and microgrid was available for power.*

Who (what) were drivers and who (what) were opponents (barriers) – and why?

*A key driver was the reliability and efficiency goals outlined by UT Austin's Natural Resources Conservation Plan.<sup>3</sup> It states:*

- *Utilities and Energy Management (UEM) will maintain utility system performance at, or above its current level of reliability and annual average plant efficiency of about 88%, average electrical generation performance of about 8,500 BTU/kWh and chilling station performance at approximately 0.70 kW/ton.*
- *CPFM will continue to anticipate changes in campus demand and plan to meet these new requirements using existing equipment and systems, avoiding additional major capital investment, to the extent possible.*

### **6.29.5.2 Design Considerations**

#### Chilled Water

- UT Austin has a proven existing system
- Uses Tunnel + Direct Buried pipe
- Has Station Redundancy.

#### Heating Water

- Design a New System
- Use Fuel Diversity
- Provide Geographic Diversity.

#### Avoid Single Points of Failure

- Provide N+1 pumps and tower cells
- Design Looped Piping
- Main tie main switchgear use double ended substations for redundancy..

#### What have been the main challenges regarding decision finding?

*We were able to incorporate all of the objectives.*

- *Chilled Water – We were able to provide a connection to and from the existing chilled-water loop on campus so that existing campus plants (45 K tons) could provide support to the district, and when not needed, to support the Medical District the main campus could benefit from the new high-efficiency cooling plant (15.6 k Tons). We are also able to maintain two connections to the Medical District from the new plant and also from the main campus. The plant also has space to add 5,000 more tons in the future as needed to support the district.*
- *Thermal Storage – We added a 5.5 million gallon (50,000 ton-hr) chilled-water thermal energy storage (TES) connected to and from the new plant that serves the Medical District and the main campus.*
- *Heating Water – We built triple redundancy for the hot water loop to the district. One source is the 600-ton heat pump chiller. The second source is two hot water boilers needed when the heat pump chiller cannot operate due to low loads and a third source of a steam-to-hot-water plant served by the main campus CHP system. The plant is designed to add two more heat pump chillers, an additional hot water boiler and another steam-to-hot-water plant can be added as needed when the Medical District grows.*
- *Electrical – We constructed new electrical conduits to connect double ended substations to the new plant and to the Medical District buildings with sufficient capacity to expand as needed. The addition of the TES coupled with the existing 4 million gallon TES has allowed*



*the campus to cut peak power by 6 MW at this point. This meets the objective of avoiding the addition of more power plant and allows the campus to add space to avoid the additional investment. We are optimizing this and expect to achieve about a 10 MW peak reduction.*

### **6.29.5.3 Vulnerable Road Crossing for Distribution Pipes**

We were able to plan and implement a dual crossing of the road. One crossing is safely located in an existing tunnel and the other is a direct buried high density polyethylene (HDPE) pipe for chilled water and an insulated steel pipe for the hot water system. The dual connection for the hot water is obtained via the steam delivered by an existing tunnel serving the steam-to-hot-water plant for the district.

The distribution piping for the district was all located under new sidewalks and safely away from buried utilities. This was all carefully documented for future reference.

What was finally the crucial parameter for go /no-go decision?

*The crucial parameter for the go ahead was proving the central plant concept rates for chilled water and hot water were less expensive than standalone equipment in the respective buildings. The 30 year net present value savings was about \$12 Million over 30 years.*

### **6.29.5.4 Financing Issues**

What have been the main challenges/constraints regarding financing?

*Financing was not an issue because the respective electrical, steam, and chilled-water rates from the utility operation provide the revenue stream pay for the debt. The university has extremely good financing rates so it was just necessary to show so that they could not afford the standalone systems in the buildings.*

Which business model applies to the project?

*Design, Build, Own, Operate & Maintain by University of Texas Austin.*

### **6.29.5.5 Technical Issues**

What have been major technical challenges/constraints regarding system design?

- *Fast tracking, developing the utility master plan in 3 months.*
- *The new 15,000 ton plant and 5.5 million gallon TES had to be constructed in 2 years. This was accomplished.*
- *The new higher peak electricity demand, in particular the peak summer cooling energy required, was projected to strain the existing power generation assets beyond their best efficiency point. Instead of building more capacity, the university installed a second TES tank to provide 50.00 ton-hours of storage and displace 10,000 tons of chilled-water-producing equipment during the peak hours of the day, approximately 6 MW.<sup>7</sup>*

What solutions have been considered for generation, storage and load management?

*Thermal Energy Storage to reduce peak demand (see above).*

### 6.29.5.6 Design Approach Applied

Which design targets have been set and why?

*We had constructed a 15,000 ton all variable frequency drive (VFD) plant in 2007 and a 3,750 ton all VFD plant in 2012 so we conducted lessons-learned sessions with the design and construction team and site visits of the two sites to set the design targets. The objective was to be more efficient in cooling than the 2007 plant, which is the most important energy because we produce all electricity. The new plant could not affect the campus overall generation efficiency.*

Which decision steps/workflow lead to the retained solution?

*The following decisions lead to the retained solution:*

1. *Determined the basis for the 15,000 tons of chiller plant. Do we use 3- 5,000 ton chillers, do we use 6 – 2,500 ton chillers and should they be in parallel or in series?*

*Using York expertise, we performed a cost benefit analysis. What would be the expected cost to construct each option (first cost of chiller, expected construction cost of each configuration and what would be the expected kw/ton for each configuration?. The parallel arrangement for the 6-2,500 ton chillers won out.*

2. *Determine how to configure the 600 ton heat pump chiller. It was decided to install it side-car to the chilled-water loop dedicated to produce hot water at 150 °F.*
3. *Determine how big can we build the TES. We wanted it as big as we could afford but there was a restriction on how tall it could be due to a requirement that the view to the Texas Capital could not be obstructed when viewed from I-35 (east of the plant site). We were able to construct it to about 86 ft in height by 105 ft in diameter.*
4. *Determine how to configure the TES to new plant to main campus to Medical District (Figure 145).*

	New GSF	District Cooling	Decentralized Air-Cooled	Decentralized Water-Cooled
UT Research	280,000	\$4,986,942	\$4,980,756	\$5,397,709
MOB	235,500	\$4,194,374	\$4,189,172	\$4,539,859
Parking Garage	0	\$0	\$0	\$0
Hospital	515,000	\$9,172,410	\$9,161,033	\$9,927,929
School of Medicine	191,700	\$3,414,274	\$3,410,039	\$3,695,503
<b>Total</b>	<b>1,222,200</b>	<b>\$21,768,000</b>	<b>\$21,741,000</b>	<b>\$23,561,000</b>
<b>NPV (30 Yrs)</b>		<b>\$40,259,000</b>	<b>\$55,770,000</b>	<b>\$51,764,000</b>

Figure 145. Configuration of TES to new plant to main campus to Medical District.

### What parameters are controlled via monitoring?

*To ensure the best operation from the existing chiller plant, chiller plant No. 6, and the new chiller plant for the Medical District, chiller plant No. 7, multiple-plant “sweet spot” controls will be employed to keep both chilled-water stations loaded to their lowest energy points. This optimization program will continuously monitor efficiency at both stations and adjust the flow setting point from CS7 to keep the entire system operating at the lowest possible overall kilowatts per ton.*

*The Termis Live Chilled-Water Model allows UT Austin to compare expected building loop pressures with live data via real-time model to spot and remedy cooling issues before they impact the customer.*

### **6.29.6 Resilience**

#### Which threats were considered and are to be considered? Are there redundancies in the energy supply system? Are there backup systems? On which time-scale can they be accessed?

*The University of Texas Austin, including the Medical District, has 100% onsite generation capacity, including N+1 redundancy for prime movers under 99% of all load conditions. This provides flexibility to serve the critical research customers and Medical District. UT Austin also has a redundant electric interconnection to the Austin Energy grid to provide 2N+2 system redundancy for nearly all system load conditions.*

*Microgrid systems with CHP, similar to the system at UT Austin, have proven to be resilient during events such as Hurricane Harvey. At the University of Texas Medical Branch in Galveston, TX, a 6 MW combustion turbine operated in island mode throughout and after Harvey while the site’s two utility feeders were down due to excessive flooding. At the Texas Medical Center in Houston, TX, the 48 MW combustion turbine was able to provide critical power and thermal energy for hospital patients and staff during Harvey. As the intensity and number of storms similar to Hurricane Harvey, it is becoming increasingly more important for energy systems to incorporate resiliency.*



*The 5,500,000 gallon TEST provides flexible chilled-water capacity that can be deployed to cover both planned and unplanned equipment outages.*

*Hot water plant No. 1 provides 40 MMBtu of backup steam-fired heating water capacity to the Medical District using steam from the campus CHP system.*

*Loss of water to the facility would mean almost immediate shut down, so several contingencies were put in place. To ensure water supply resiliency, four independent water sources are piped to the chilling station that are each deployed on an economic basis. The sources include recovered water from campus air handling unit coil condensate, reclaimed water from the city of Austin, domestic water from the city of Austin, and domestic water from the university-owned system. The domestic water from the city of Austin and university-owned system provide additional redundancy but are used only as backups to the other sources.<sup>7</sup>*

*O&M considerations such as, bridge crane and monorails, commonality of components, catwalks were included for resiliency. Also, the PLC Control System includes programming in the case of failure.*

## 6.30 Solar Thermal at the UC Davis California National Primate Research Center

Case No.	Country	Location	Specific Type	Photo	Special points of attention
30	USA	Davis	Campus Research Center		 <p>district energy system, critical infrastructure, solar thermal</p>
<b>Country:</b>		United States			
<b>Name of city/municipality/public community:</b>		Davis, California			
<b>Title of case study:</b>		Solar Thermal at the UC Davis California National Primate Research Center			
<b>Author name(s):</b>		Laxmi Rao (IDEA) , Joseph Yonkoski ( UC Davis)			
<b>Author email(s):</b>		<a href="mailto:laxmi.idea@districtenergy.org">laxmi.idea@districtenergy.org</a> , <a href="mailto:ikyonkoski@ucdavis.edu">ikyonkoski@ucdavis.edu</a>			
NOTE: The study phase of the project has been completed. The campus has sought funding approval for design phase, and is now (Autumn 2020) moving into construction.					
University of California Davis, University of California Davis California National Primate Research Center. <a href="https://cnprc.ucdavis.edu/about-us/">https://cnprc.ucdavis.edu/about-us/</a>					
Affiliated Engineers, Inc. "UC Davis - CNPRC Steam System Assessment & Energy Master Planning." University of California, Davis. August 21st, 2018.					
California ISO. "Today's Outlook." November 26, 2018. <a href="http://www.caiso.com/TodaysOutlook/Pages/Supply.aspx">http://www.caiso.com/TodaysOutlook/Pages/Supply.aspx</a>					
USEPA. eGRID Summary Tables. 2016. <a href="https://www.epa.gov/energy/egrid-summary-tables">https://www.epa.gov/energy/egrid-summary-tables</a>					

### 6.30.1 Background and Framework

The California National Primate Research Center (CNPRC) is an Organized Research Unit of the University of California (UC), Davis and is part of the National Primate Research Centers Program at the National Institutes of Health. Located about 2 miles to the west of the UC Davis main campus in Davis, California, the CNPRC has its own district energy system (see Figures 146-150).<sup>1</sup>





Existing Chiller at Primate Center

Figure 148. Existing chillers at Primate Center (Source: Affiliated Engineers).

**UC DAVIS**

**CNPRC Heating and Cooling Improvements**

The CNPRC Heating and Cooling Improvement project will replace the old and inefficient heating and cooling equipment with new energy-efficient systems. This will include constructing a modular building to house the new equipment and develop a new solar thermal panel field to offset operating cost and lower carbon emissions. This project will also provide additional capacity for future capital projects within the CNPRC district.

Approval for Preliminary Plans

12/18/18

Approval for Budget, Design & Environmental

TBD

Chancellor's Committee on Campus Planning and Design      December 18, 2018

Figure 149. CNPRC heating and cooling improvements (Source: Affiliated Engineers).

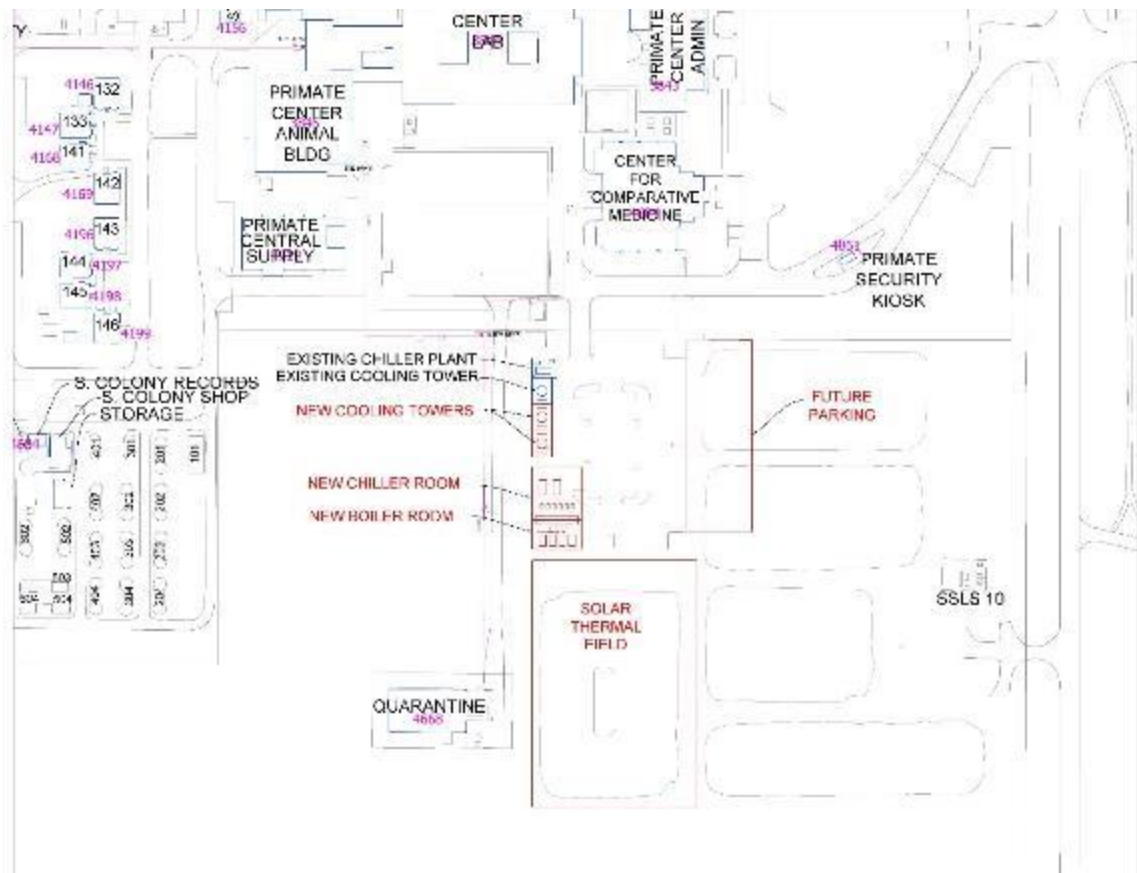

Figure 150. Site Plan of UC Davis (Source: Affiliated Engineers).

### 6.30.1.1 Emissions Reduction Context

The University of California’s (UC) Policy on Sustainable Practices set the following GHG emission reduction goals for all UC campuses:

- Reduce GHG emissions to 1990 levels by 2020
- Achieve carbon neutrality by 2025.

The University of California Davis campus created the 2009-2010 Climate Action Plan (CAP), which outlines how the campus will meet the UC Policy on Sustainable Practices emissions goals and addresses other policies from organizations including the California Air Resources Board (CARB), the American College and University Presidents’ Climate Commitment (ACUPCC), the California Environmental Quality Act (CEQA), and the USEPA. The CAP outlines several options to reach these goals including energy conservation, energy efficiency, renewable energy sources, alternative energy options, and carbon sequestration.<sup>2</sup>

### 6.30.1.2 Energy Market Context

In 2018, California Independent System Operator’s electricity supply is 42.5% from renewables, 28% from natural gas, 5.1% from large hydro, 15.2% from imports, 9.2% from nuclear, 0.1% from coal,

and 0% from other sources. Renewable sources supplying the California grid includes 77.7% solar, 9.4% geothermal, 5.5% wind, 3.6% biomass, 2.3% biogas, 1.6% small hydro, and 0% batteries.<sup>3</sup>

### 6.30.1.3 Energy Factors

According to the USEPA’s Emissions & Generation Resource Integrated Database (eGRID), UC Davis is located in the Western Electricity Coordinating Council (WECC) California region (CAMX) of the U.S. electrical grid. Table 58 lists the total output emission rates and non-baseload output emission rates for CAMX according to eGRID2016.<sup>4</sup>

**Table 58. CO<sub>2</sub> Emission rates, total and for non-baseload output.**

	<b>Total output emission rates (kg/MWh)</b>	<b>Non-baseload output emission rates (lb/MWh)</b>
CO <sub>2</sub>	239.7	428.1

### 6.30.2 Project Objectives

In an effort to support the CAP, UC Davis explored options to reduce energy consumption and GHG emissions by completing a district energy master plan for the CNPRC. The study evaluated many alternatives with a LCCA. Innovative solutions proposed to replace the aging steam infrastructure and absorption chiller plant included electrification and a transition to 100% renewable energy.

The main objectives of the study at the CNPRC are:

1. Evaluate options to lower current operating expenses for the CNPRC district heating and cooling systems; including alternatives that would reduce labor expenses by eliminating the 24/7 boiler watch.
2. Improve the heating and cooling systems reliability and redundancy.
3. Reduce the carbon footprint of the CNPRC campus.
4. Increase efficiencies of the CNPRC heating and cooling systems.
5. Investigate how the findings of this report could be applied to the main UC Davis campus.

UC Davis will also explore demand side load reduction measures to further reduce the energy consumption and GHG emissions from the CNPRC campus.<sup>2</sup>

### 6.30.3 Existing Heat and Power Supply

The CNPRC campus is currently served by natural gas provided by Pacific Gas and Electric Company (PG&E), landfill gas piped from the existing UC Davis landfill, and high voltage electricity provided by Western Area Power Administration (WAPA).

Steam and chilled water are generated onsite at the CNPRC Combined Heating and Cooling Plant (CHCP) to serve nine buildings on campus. Other small and/or temporary buildings on the CNPRC campus are served by standalone heating and cooling systems.<sup>2</sup>



## 6.30.4 Recommended Heat and Cooling Supply

### 6.30.4.1 Supply Side Recommendations<sup>2</sup>

- Solar Thermal heating system supplemented by gas-fired hot water boilers with a new heating hot water (HHW) distribution system. Converting from steam to hot water distribution greatly reduces thermal losses and maintenance costs. Hot water distribution also allows more flexibility with alternative heat sources such as geo-exchange, air side heat recovery using heat pumps, and air source heat pumps.
- Electric chillers to provide cooling.
- TES for hot water.
- Future electrification through Geo-exchange to further reduce energy costs and GHG emissions (See Table 59-63).

### 6.30.4.2 Demand Side Recommendations<sup>2</sup>

- Reduce the air change rates for the animal spaces to that which maintains a healthy environment for the animals while also minimizing energy use. Reducing the air change rates to 12 ACH could save nearly 20% of the campus' annual energy consumption and carbon emissions. This is still within the limits established by the *Guide for Care and Use of Laboratory Animals*
- Perform a lighting study to create an accurate baseline for future lighting reduction studies.<sup>2</sup>

**Table 59. General quantitative information on energy supply at UC Davis.**

	Urban scale of area [m <sup>2</sup> ]	Total gross floor area [m <sup>2</sup> ]	Heated floor area [m <sup>2</sup> ]	Population/Users in the area
Before	32,483	17,339	8,561	NA
BAU	32,483	17,339	8,561	NA
After	32,483	17,339	8,561	NA

Table 60. Details on Energy Supply System of UC Davis, Baseline, Basecase and Preferred Scenario. All heating and cooling demands include distribution losses. Of the thermal energy demand – heating, the total 21,500 MMBtu/yr, is comprised of 3,500 MMBtu/yr of solar thermal energy demand and 18,000 MMBtu/yr of hot water boiler energy demand.

	Heating Network Losses [%]	Cooling Network Losses [%]	Heating grid trench length [ft]	Cooling grid trench length [ft]	Number of consumer substations; heat	Number of producer substations; heat	Heating Supply Temperature [°F]	Heating Return Temperature [°F]	Cooling Supply Temperature [°F]	Cooling Return Temperature [°F]	TES volume [gal]	Thermal energy demand – heating [MMBtu/yr]	Cooling energy demand [MMBtu/yr]	Electrical energy demand [MWh/yr]	Annual electric energy yield [MWh/a]
Before	20	NA	1,200	NA	1	0			40	55	0	43,900	14,200	85	NA
BAU	20	NA	1,200	NA	1	0			40	55	0	25,500	14,200	1,040	NA
After	5	NA	1,200	NA	1	0	160	120	40	55	2,000	21,500	14,200	1,040	NA

Table 61. Project additional information.

<b>Additional information:</b>	
Building mix in the area*:	Non-residential
Consumer mix in the area**:	Large
Energy plant owner (public or private):	Public
Thermal energy supply technologies***:	See table below
Thermal Energy Production from solar:	5,000 MMBtu/yr
Thermal energy storage:	150,000 gal
Battery storage:	N/A
Investment costs****:	1550 \$/m <sup>2</sup> conditioned area
Cooling energy used:	1,180,000 ton-hr
Available cooling power:	1,000 tons
Electrical energy demand:	1,040 MWh/yr
Electric power supply technologies:	N/A
Backup power, critical demand:	See table below

**Table 62. Thermal energy supply technologies.**

	<b>Existing Steam System</b>	<b>Recommended Solar Thermal System</b>
District Heating	<ul style="list-style-type: none"> <li>• 7,000 lb/hr Hurst boiler – Natural Gas &amp; Landfill Gas</li> <li>• 10,000 lb/hr Hurst boiler – Natural Gas</li> <li>• Backup fuel oil system</li> </ul>	<ul style="list-style-type: none"> <li>• 300 hot water solar thermal panels (17% of annual demand)</li> <li>• Three new supplemental hot water boilers – Natural Gas (4 MMBtu/hr each)</li> <li>• Four 1.4 MMBtu/hr water source electrical heat pumps</li> <li>• “California Special” steam boilers that will not require 24/7 boiler watch will be installed at buildings with process steam loads</li> </ul>
District Cooling	<ul style="list-style-type: none"> <li>• 390-ton single effect absorption chiller (in CHCP)</li> <li>• 170-ton water-cooled chiller (on roof of CCM)</li> <li>• 130-ton water-cooled chiller (on roof of ANW)</li> <li>• 26-ton air-cooled chiller</li> <li>• New 500-ton water-cooled chiller plant with new pumps and cooling towers (scheduled to be installed in 2018)</li> </ul>	<ul style="list-style-type: none"> <li>• Two 500-ton electric chillers</li> <li>• Two 585-ton cooling tower cells (to serve chillers and provide redundancy)</li> </ul>

**Table 63. Hot water production.**

	<b>Solar Thermal</b>	<b>Hot Water Boilers</b>
Percentage of CNPRC Heating Load	Approx. 45% from solar thermal with heat pump	55%

What is happening to the old steam system?

*The old steam system will no longer serve the CNPRC. The distribution piping will be removed or abandoned. The boilers will be retired. The project will replace the existing steam boilers with new hot water boilers and hot water distribution piping.*

**6.30.5 Technical Highlight**

The unique district lends itself to interesting energy supplies, including biogas from a nearby landfill and biodigester (Figure 151) and solar thermal hot water generation for heating (Figure 152).

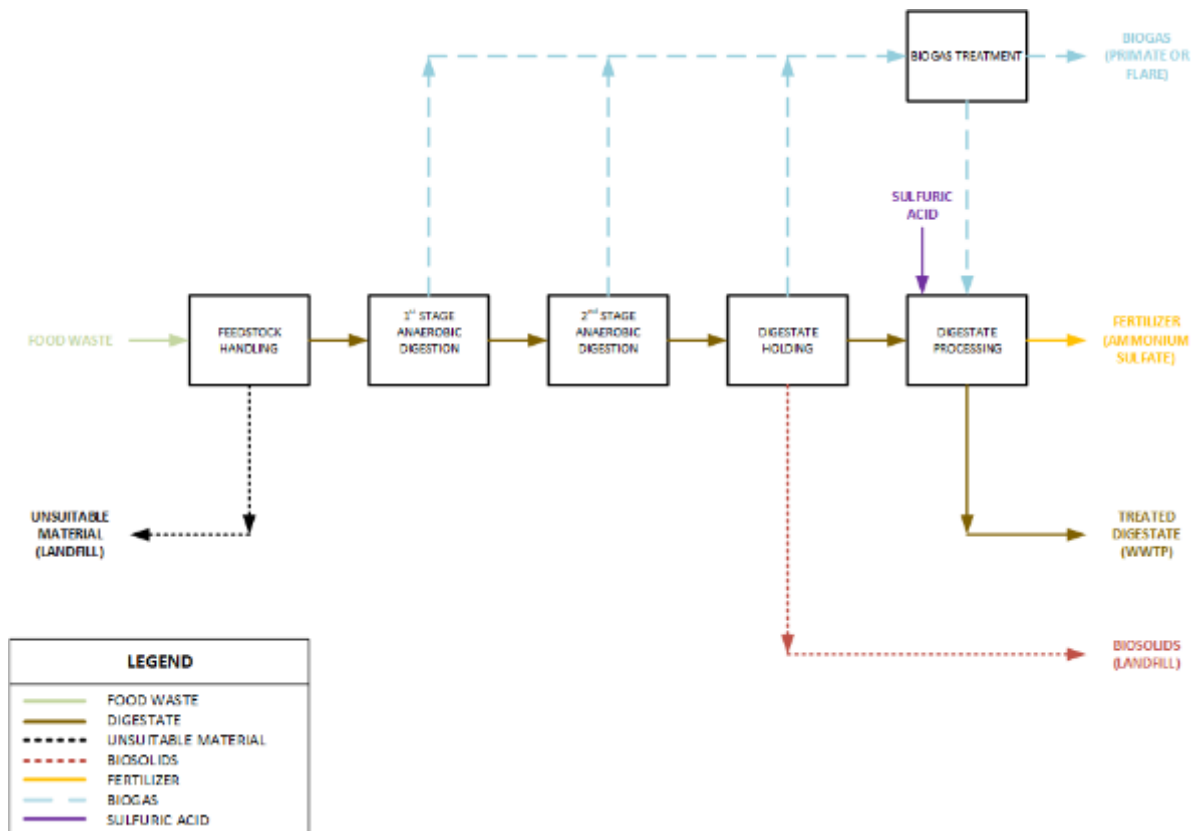

Figure 151. Schematic of the biodigester process.

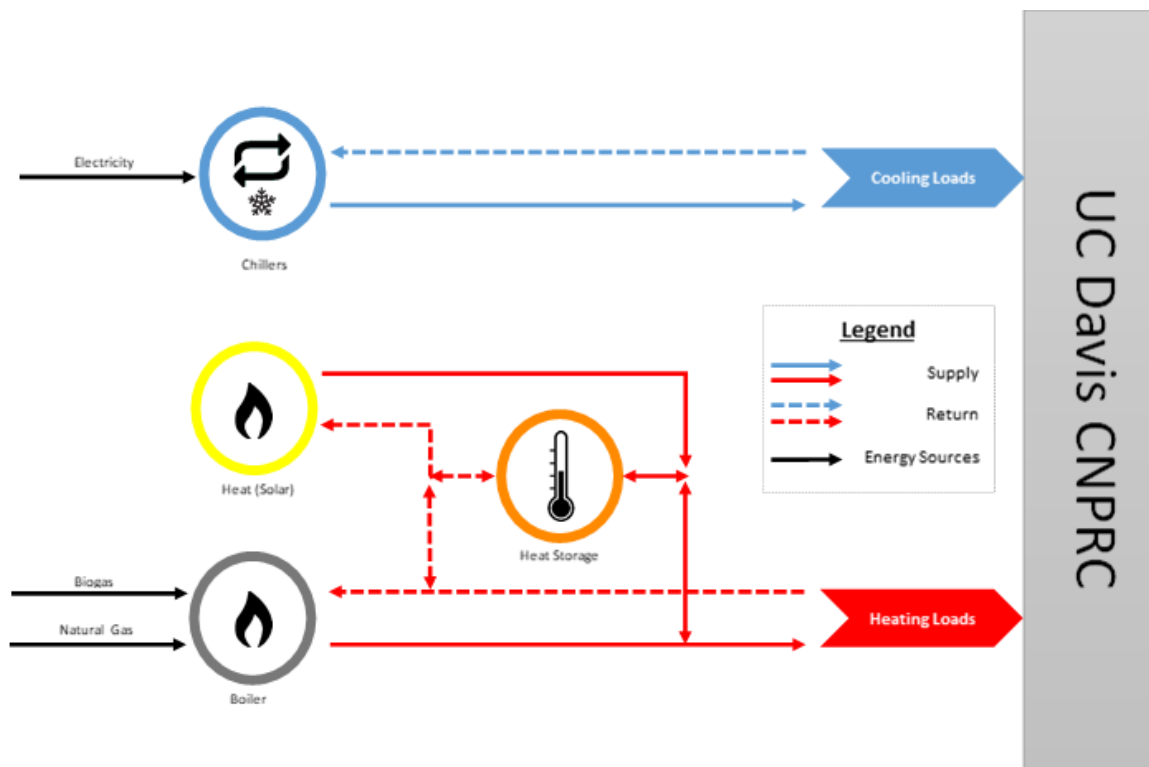

Figure 152. Energy system architecture of UC Davis.

## 6.30.6 Design and Decision Process

### 6.30.6.1 General/Organizational Issues

Why was this project initiated, to answer which need?

*This project was initiated to address the aging steam system at the CNPRC and to help reach the emission reduction goals of UC Davis and the University of California's Policy on Sustainable Practices.*

Which stakeholders were involved in the project?

*UC Davis CNPRC was involved in the project, as were Utilities staff, Central Plant personnel, Campus Sustainability, and Design and Construction Management for project execution.*

Which resources were available before the project? What are local energy potentials?

*The existing steam system and district cooling system were available before the project. Also, UC Davis received over 2,000 hot water solar thermal panels (Figure 153) as a donation before the project from Fountain Financial Partners, LLC and Apartment Solar Finance, LLC.*



Donated Solar Thermal Panels from UCOP

**Figure 153. UC Davis donated solar panels (Source: Affiliated Engineers).**

Who (what) were drivers and who (what) were opponents (barriers) – and why?

*The aging district heating and cooling systems were significant drivers for the project. In addition to reducing GHGs and improving energy efficiency, increasing the reliability and improving equipment redundancy were significant goals of the project.*

What have been the main challenges regarding decision finding?

*To make the decision regarding which possible solution to select, a thorough technical and economic analysis was required. Identifying and understanding non-economic advantages of certain solutions also was also challenging (i.e., the option with the lowest net present cost was not selected because it did not align as well with other project goals).*

What was finally the crucial parameter for go /no-go decision?

*The project recently completed the study phase and has yet to reach the go/no-go decision.*

### **6.30.6.2 Financing Issues**

What have been the main challenges/constraints regarding financing?

*The project has yet to be financed as it has not yet entered into the design phase. However, the project expects to earn rebates through the California Solar Initiative rebate program to help offset project costs. The project will be funded by the campus.*

Which business model applies to the project?

*The project will be funded by the campus and expects to earn rebates through the California Solar Initiative rebate program to help offset project costs. A landfill/biogas mixture from the campus' nearby landfill and biodigester facility will be used to reduce the dependency on the natural gas supply.*

### **6.30.6.3 Technical Issues**

What have been major technical challenges/constraints regarding system design?

*Selecting the number of solar thermal panels and TES size is a technical challenge. Too few panels result in less natural gas offset, too many panels results in an abundance of heat production in the summer months. The project settled on 300 panels, which provides approximately 45% of the total annual heat demand when the heat is upgrade with heat pumps and achieves a potentially significant California Solar Initiative rebate.*

What solutions have been considered for generation, storage and load management?

*Other solutions considered for the project included: <sup>2</sup>*

- *Maintain the existing boilers and add new electric chillers*
- *Install new boilers and new electric chillers*
- *Install heat recovery chillers and TES*
- *Install a CCHP system*
- *Install Geo-Exchange.*

### **6.30.6.4 Design Approach Applied**

Which decision steps/workflow lead to the retained solution?

*UC Davis completed a Steam System Assessment and Energy Master Planning report for the University of California Davis CNPRC using current data and pricing to explore options to reduce energy consumption and GHG emissions. A lifecycle cost analysis was performed that included*

the capital cost, annual electricity cost, annual natural gas cost, annual operating expenses, annual water costs, and annual carbon costs (Figure 154). After analysis it was recommended that UC Davis should continue with the Solar Thermal option.<sup>2</sup>

The proposed project will be evaluated with an Initial Study Checklist and direct-approval findings for CEQA compliance. CEQA compliance will be completed before design approval. This project will comply with applicable UC Davis sustainable design practices. (Source: Affiliated Engineers, Gene's materials)

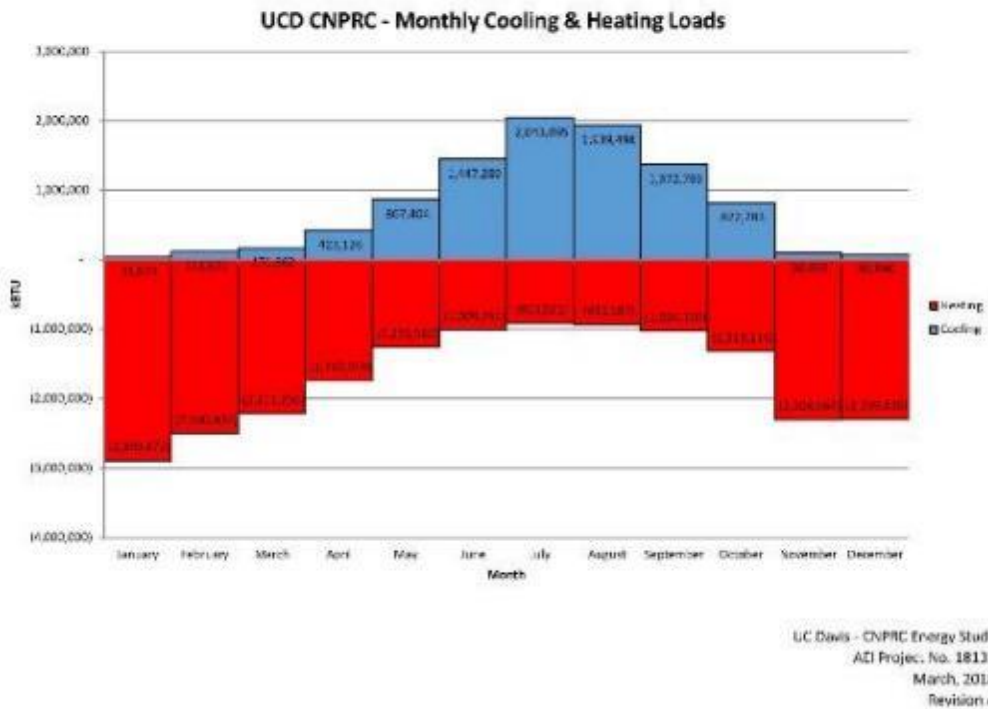

Figure 154. UC Davis monthly cooling and heating loads (Source: Affiliated Engineers, Gene's materials).

### 6.30.6.5 Trane Trace Energy Model (Created by UC Davis in 2008)

What have been the main challenges in the design phase?

The project has recently completed the study phase and will soon enter the design phase. For challenges in the study phase see previous questions.

The central heating and cooling plant and distribution system will be executed using the design/bid/build methodology. The solar thermal system will be executed as a separate project using the design-build approach.<sup>2</sup>

What have been the most crucial interfaces?

*In the study phase, the most crucial interface is the interface with the design consultant. It is important that the consultant understands the project drivers that information is communicated to and from the consultant regularly with relevant stakeholders.*

What parameters are controlled via monitoring?

*As the project has yet to be built, the exact control system details are not yet known. However, to optimize the use of the solar thermal collectors, it is planned to use the heat produced by this system before the use of hot water boilers. An 18,000 gallon TEST will allow for some load shifting and further optimization.*

*When the heating demand exceeds the solar thermal output, the hot water boilers will turn on and burn landfill/biogas if it is available.*

### 6.30.7 Resilience

Resilience in this context describes the capacity of a system to respond to a perturbation or disturbance by resisting damage and recovering quickly. Such perturbations and disturbances include stochastic events such as fires, flooding, windstorms, and slow long-term changes like the depletion of energy reserves and climate change. Here, we focus on the effect for the energy supply of vital processes of the concerned neighborhood.

Table 64 lists, for different energy forms, the maximum and critical loads, and whether critical loads can be covered by the backup system.

**Table 64. Maximum loads and critical loads.**

Load	Power [MW]*			Heat [kBtu/hr]			Cooling [tons]		
	Maximum	Critical	Covered by backup?	Maximum	Critical	Covered by backup?	Maximum	Critical	Covered by backup?
BAU	880	440	No	25,000	6,000	Yes	1,000	500	No
Realized	880	440	No	12,000	6,000	yes	1,000	500	No

\*Note: Power is for producing chilled water.

Which threats were considered and are to be considered? Are there redundancies in the energy supply system? Are there backup systems? On which time-scale can they be accessed?

*The proposed heating system is diverse in its heating supply. In the event solar thermal panels cannot provide sufficient heat, hot water boilers can supplement the heating load. The hot water boilers can be fueled by two sources: biogas from a nearby landfill/biodigester facility, or natural gas from a PG&E pipeline. It has not yet been decided whether the existing fuel oil system will be maintained for backup.*

What is the degree of autarky?

*Approximately 45% of the heating load is provided by solar thermal panels when the heat is upgraded with a heat pump. Potentially, all of the remaining heat load can be met with biogas*



from a nearby facility. In the event the biogas production is insufficient or intermittent, the facility will rely on natural gas.

## 6.30.8 Lessons Learned

### 6.30.8.1 Major Success Factors

Major success factors include having a well-rounded project team that encompasses major stakeholders as well as having a framework with which to evaluate proposed alternative options. The framework deployed on this project consisted of an economic evaluation of the lifecycle cost, an evaluation of whether the option would align with campus initiatives, and an evaluation of whether the solution would provide sufficient reliability and redundancy to a center where the inability to meet demand is not acceptable.



### 6.30.8.2 Major Bottlenecks/Major Lessons Learned

The project is still in an early phase and has yet to undergo design and construction and therefore has not experienced significant bottlenecks or had major lessons learned.

What should be transferred from this project?

*The CNPRC will be used to demonstrate the feasibility, cost, effectiveness, and challenges faced in implementing energy efficiency and environmentally friendly projects throughout the campus. The EMP has provided an opportunity for further refinement of design.*

## 6.31 The Evolution of Low Carbon District Energy and Innovative Solutions at University of British Columbia

Case No.	Country	Location	Specific Type	Photo	Special points of attention
31	Canada	Vancouver	Campus University		  district energy system, critical infrastructure

<b>Country:</b>	Canada
<b>Name of city/municipality/public community:</b>	Vancouver, British Columbia
<b>Title of case study:</b>	The Evolution of Low Carbon District Energy and Innovative Solutions at University of British Columbia
<b>Author names and emails:</b>	Laxmi Rao, <a href="mailto:laxmi.idea@districtenergy.org">laxmi.idea@districtenergy.org</a> Joshua Wauthy, <a href="mailto:joshua.wauthy@ubc.ca">joshua.wauthy@ubc.ca</a> Paul Holt, <a href="mailto:paul.holt@ubc.ca">paul.holt@ubc.ca</a>
<b>References</b>	British Columbia (2020). International District Energy Association (2015). UBC. Undated[a] International District Energy Association (2018). UBC (Undated[b]). Galkin-Aalto (2018).

### 6.31.1 Background and Framework

The University of British Columbia (UBC) in Vancouver, Canada is a global center for research and teaching, consistently ranked among the 40 best universities in the world. Since 1915, UBC's entrepreneurial spirit has embraced innovation and challenged the status quo. It is this groundbreaking spirit that has driven the transformation of UBC's Academic District Energy System (ADES) over recent years (Figures 155 and 156).



**Figure 155.** The district energy system at the University of British Columbia includes the Campus Energy Centre and the Bioenergy Research and Demonstration Facility, a biomass cogeneration system (Source: UBC 2015).

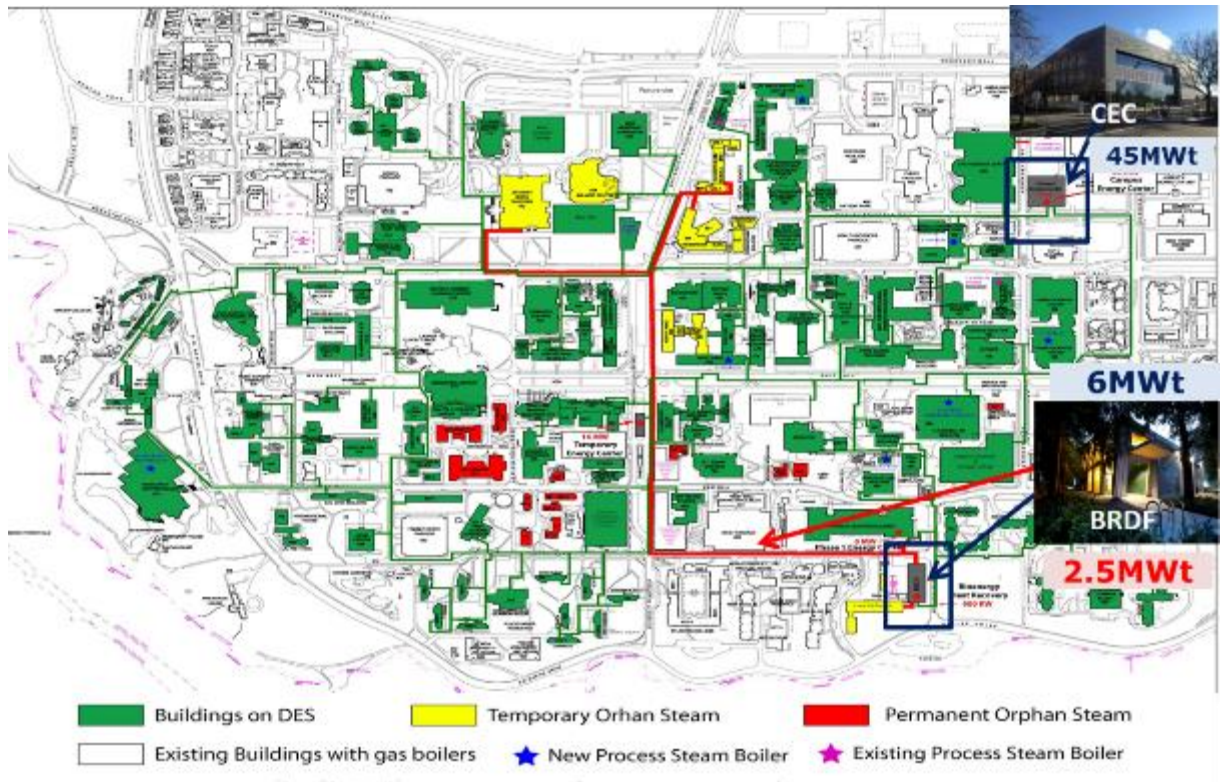

**Figure 156. The Academic District energy system as of December 2015 including the Campus Energy Centre (CEC) and the Bioenergy Research and Demonstration Facility (BRDF) (Source: UBC 2015).**

### 6.31.1.1 History of Innovation & Sustainability

UBC’s ADES has a long history of innovation and sustainability – continually seeking to reduce its energy and emissions. The steam district’s original 1925 coal-fired boilers were converted to fuel oil in the 1950s and then to natural gas in the 1960s. In 1990, UBC signed the Talloires Declaration, pledging to make sustainability the foundation for all campus operations, research, and teaching and was the first university in Canada to adopt a sustainable development policy. In 1998, UBC opened a Sustainability Office and subsequently launched the EcoTrek program, the largest energy and water retrofit program of its kind at a Canadian University, retrofitting 288 buildings and significantly upgrading UBC’s steam ADES with boiler economizers, low NOx burners, and condensate return. The project enabled UBC to achieve its 2007 Kyoto protocol commitments of reducing GHG emissions 7% compared to 1990 levels.

The year 2007 was the point of departure of the next transformation of UBC’s ADES (Figure 157), which halved its natural gas use through conservation, efficiency, and renewable energy projects. By 2017, the aging steam ADES was decommissioned, replaced with an efficient hot water ADES energized by a renewable biomass boiler, waste heat recovery from a biomethane-fueled cogeneration engine, and high-efficiency natural gas-fired hot water boilers for peaking.

From 1925 to present, UBC continues to provide reliable, cost-effective, and increasingly sustainable utilities to its campus and broader community. For those who work, study, live, and

play at UBC, utilities are served to multiple facilities including: 400 core academic, research and animal care buildings, 12,000 housing beds, an Olympic size swimming pool and other athletic facilities, 330 bed hospital, and the world's largest cyclotron.

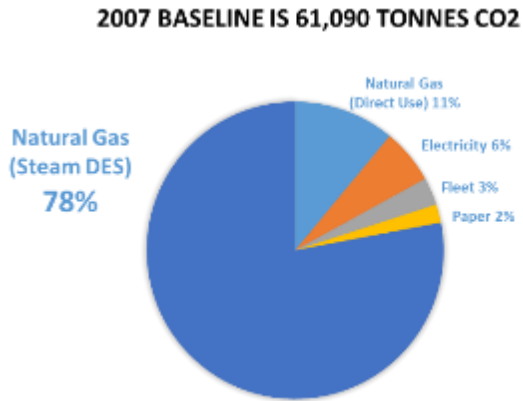

**Figure 157. Baseline of UBC in 2007.**

### 6.31.1.2 GHG Inventory and Carbon Costs

In 2007, UBC undertook its first comprehensive campus GHG inventory, which clearly showed more than three-quarters of GHG emissions came from its natural gas fueled steam ADES. This was unsurprising given that the Canadian province of British Columbia's (BC) electricity is 98% from hydro-electricity and other clean sources with an emission factor of 3 kgCO<sub>2</sub>e/GJ compared with 50 kgCO<sub>2</sub>e/GJ for natural gas.

In 2008, BC implemented North America's first broad-based carbon tax to reduce emissions, encourage sustainable economic activity and investment in low carbon innovation. Introduced at that time as \$30/tCO<sub>2</sub>e, in April 2018, British Columbia raised the carbon tax rate to \$35 per tonne of carbon dioxide equivalent emissions and will continue to increase by CA\$5 per tonne each year until it reaches CA\$50 per tonne in 2021.<sup>1</sup>

Also introduced in 2008 was a Carbon Neutral Public Sector bill, which required all public institutions to become carbon neutral through, first reducing GHG emissions and meeting provincial carbon reduction targets, and second by paying carbon offsets on the remaining GHG emissions. This added an additional \$25/tCO<sub>2</sub>e to UBC's carbon tax. UBC's carbon emissions cost CA\$2.5 million in 2014 due to the carbon tax of CA\$30 per metric tonne of carbon emitted and a carbon offset of CA\$25 per metric tonne.<sup>2</sup>

UBC's GHG inventory and increasing cost of carbon focused UBC's attention and study to its Steam DES and on possible alternative energy solutions and delivery mechanisms.

### 6.31.2 Climate & Energy Objectives

In 2010, the UBC CAP was implemented to establish significant but achievable GHG emission reduction targets. UBC set the following GHG emission reduction targets from a 2007 baseline and were twice as aggressive as those set by the BC Provincial Government:

- 33% reduction by 2015
- 67% reduction by 2020
- 100% reduction by 2050.

The plan established three main projects that would help UBC achieve these goals:

- Converting its aging ADES from steam to hot water to change how efficiently the campus is heated
- Building the Bioenergy Research and Demonstration Facility (BRDF) to provide renewable heat and power
- Optimizing academic building performance and reducing energy consumption through the Building Tune-Up Program.

These milestone projects helped UBC achieve a 34% GHG emission reduction in 2016 from 2007 levels, despite a 16% increase in building floor space and a 23% increase in student enrolment.

UBC has now developed its Climate Action Plan 2020 (CAP2020) to work towards the next goal of a 67% reduction by 2020. One of the main action items from the CAP2020 was for UBC to further evaluate its energy supply options. After the analysis, UBC has proposed expanding the heating capacity of the Bioenergy Research and Demonstration Facility (BRDF) to further reduce UBC’s dependence on fossil fuels<sup>3</sup> (see Tables 65-67). Figure 158 presents a system overview of the UNC Academic District energy system.

**Table 65. Quantitative placement: Floor area and users.**

<b>Urban scale of area [acres]</b>	<b>Total gross floor area [GSF]</b>	<b>Heated floor area [GSF] DES steam and hot water</b>	<b>Population/Users in the area (students, faculty and staff)</b>
1,000	17,000,000	10,680,000	70,787

Table 66. Quantitative data on energy supply system.

	Heating Network Losses [%]	Cooling Network Losses [%]	Heating grid trench length [trench miles]	Heating Supply Temperature [°C]	Heating Return Temperature [°C]	Cooling Supply Temperature [°C]	Cooling Return Temperature [°C]	TES volume [m <sup>3</sup> ]	Thermal energy demand – heating [kWh/hr]	Electrical energy demand [kWh/hr]	Annual electric energy yield [kWh/hr]
After	3%	NA	11	120 C max design 75 C min design ~95 C typical	75 C max design 35 C min design ~65 C typical	NA	NA	Within distribution piping only. No separate tank	149,893,000	219,731,000	15,379,000

Table 67. Additional information on UBC.

<b>Additional information:</b>	
Building mix in the area*:	Residential & Non-residential (University)
Buildings on Hot Water and Steam:	146
Consumer mix in the area**:	Large
Energy plant owner (public or private):	Public
Thermal energy supply technologies***:	
Campus Energy Center:	Three hot water boilers, 154 MMBtu/hr total, NG
Bioenergy Research and Demonstration Facility:	
Two steam boilers	20,400 lb/hr total (waste wood)
GE Jenbacher engine:	700 lb/hr steam, NG & Biomethane and 3.4 MMBtu/hr, engine coolant and lube oil systems
Thermal energy storage:	N/A
Battery Storage:	Lithium Ion, 1,000 kWh/450 kW
Investment costs****:	\$88m CAD + \$9.5m CAD (recent investment costs into the Hot Water DES and Bioenergy Facility)
Cooling energy used:	Distributed chillers – difficult to quantify
Available cooling power:	Distributed chillers – difficult to quantify
Electrical energy demand:	49.119 MVA
Voltage level:	12 kV underground distribution
N of consumer substations:	Two sub-stations
Electric power supply technologies:	GW Jenbacher engine, 2 MW, NG and Biomethane
Annual electric energy yield:	5% of total campus power
Backup power, critical demand:	Distributed diesel generators

System snapshot: University of British Columbia Academic District Energy System	
Hot water/CHP system	
Startup year	1925 – Powerhouse started steam production 2012 – Bioenergy Research and Development Facility operational 2015 – Academic District Energy System including Campus Energy Centre completed
Number of buildings served	120
Total square footage served	9.9 million sq ft
Plant capacity	CEC: 154 MMBtu/hr hot water BRDF: 34,500 lb/hr steam, 37.5 MMBtu/hr heat recovery hot water, 2 MW electricity
Number of boilers	CEC: 3 hot water boilers BRDF: 2 steam boilers, 1 heat recovery steam generator, 1 engine hot water heat recovery heat exchanger system (All steam production converted to hot water via steam-to-hot-water heat exchangers)
Fuel types	CEC: Natural gas BRDF: Biomass, renewable natural gas, natural gas
Distribution network length	7.5+ trench miles
Piping type	Direct-buried insulated steel
Piping diameter range	4 to 16 inches
System pressure	100 psi average
System temperature	158-239 F supply design range

Source: University of British Columbia.

**Figure 158. System overview, UNC Academic District energy system (Source: International District Energy Association’s *District Energy Magazine*. 2018 Q2).<sup>4</sup>**

### 6.31.3 Innovative Approach to Steam to Hot-Water Conversion

The UBC’s Academic District Energy System’s steam-to-hot-water conversion was undertaken as follows. In 2010, UBC’s Powerhouse had a peak steam load of 250,000 lb/hr (120MW) and served 133 campus buildings but was the number one seismic risk for the campus. In addition, despite previous investments, it had a staggering maintenance liability of CA\$190 million and needed significant capital renewal. It was also identified as the primary source of campus GHG emissions – producing more than 50,000 tonnes of carbon dioxide annually. It was clear that there was opportunity for the installation of a cleaner, greener campus heating system: the new hot water ADES.

From 2011-2015 UBC's aging gas-fired steam district energy system was replaced, piece-by-piece, into a state-of-the-art, medium-temperature, hot water system. The CA\$88 million ADES Steam to Hot Water Conversion Project:

- Replaced 14 kilometers of 90-year-old steam piping with new insulated piping
- Converted 115 buildings to the highly efficient hot water district energy system through 105 energy transfer stations, and addressed process and legacy steam requirements in 26 buildings
- Built a 154-MMBtu/hr (45MW) natural gas fired Campus Energy Centre (CEC) able to meet all campus energy needs.

At project completion, the new system was providing space heating and domestic hot water for 115 buildings totaling more than 9.0 million sq. ft. of floor space. The project improves energy efficiency by greater than 24% and was instrumental in enabling UBC to achieve its 2015 GHG emissions reduction target.<sup>4</sup>

### **6.31.3.1 Bioenergy Research and Demonstration Facility (BRDF)**

UBC's district energy system's award winning Bioenergy Research and Demonstration Facility (Figure 159) provides the district with part of its energy needs.

In 2012, a "first of its kind" in North America CA\$28 million 6 MWt biomass gasification system and 2 MWe cogeneration unit was built to provide thermal energy and renewable electricity for the campus. It provides a quarter of campus heating needs, over 5% of the power for UBC's electrical grid, and eliminates 14% of campus GHG emissions. This LEED Gold facility serves as a "living lab" for academic research and teaching while providing an operational need for the campus.

The BRDF uses gasification technology to turn waste wood into synthetic gas, replacing natural gas used to produce 20,400 lb/hr (6 MWt) of steam that is subsequently converted to hot water for campus space heating. Today, 25% of the campus' heating and hot water needs are met by using clean wood waste.

The cogeneration process uses a combination of natural gas and biomethane to fuel a GE Jenbacher engine. The engine produces 2 MWe of electricity fed into the campus grid and also heat recovered from the engine exhaust gas to generate 4,700 lb/hr (1.4 MWt) of steam-to-hot-water heat exchangers. A further 3.4 MMBtu/hr (1 MWt) of heat is recovered from the engine coolant and lube oil systems and supplies the ADES via a glycol-to-hot-water heat exchanger (Figures 160 and 161).

The project required local community acceptance of the facility, which entailed multiple public engagement events before construction as well as a community and emissions committee during the first year of operations. Emissions, noise, aesthetics, and truck traffic were areas of concern that were addressed. Since the facility is located adjacent to a residential neighborhood, 24-hour air emission monitoring stations were installed to monitor air quality.

The building is a mass timber structure composed of exposed cross-laminated timber (CLT) panels for the walls, floors and roof, and glued-laminated timber (glulam) columns and beams



attached through steel connectors. The CLT panels were fabricated locally, mostly from regionally sourced 90% pine beetle-affected lumber. CLT panel properties include high shear strength, durable surfaces, a natural wood aesthetic, and sufficient thickness to assist with mitigating sound transmission. Work of the Vancouver’s FPInnovation on the CLT standards and testing allowed BRDF to become the first North American industrial building constructed with CLT manufactured in BC.

Looking ahead to 2020, UBC will triple the capacity of its biomass plant, which will provide energy to two-thirds of the ADES with renewable fuel sources and save an additional \$1.3 million annually.<sup>5</sup>



Figure 159. Inside the Bioenergy Research and Demonstration Facility (BRDF) (Source: Don Erhardt).

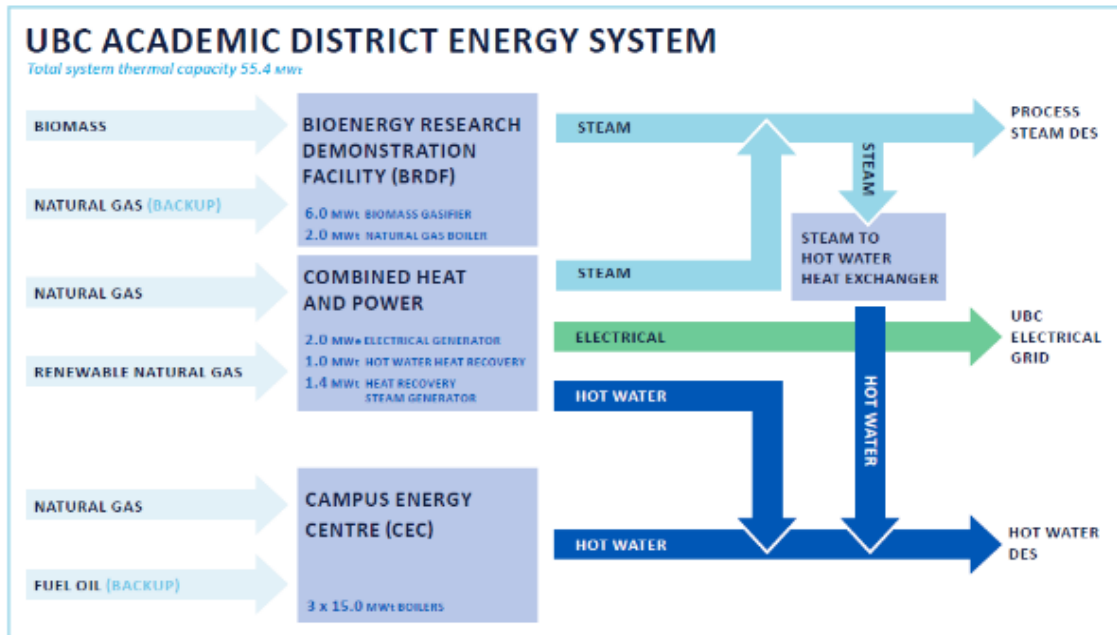

Figure 160. UBC Academic District Energy System (Source: UBC).

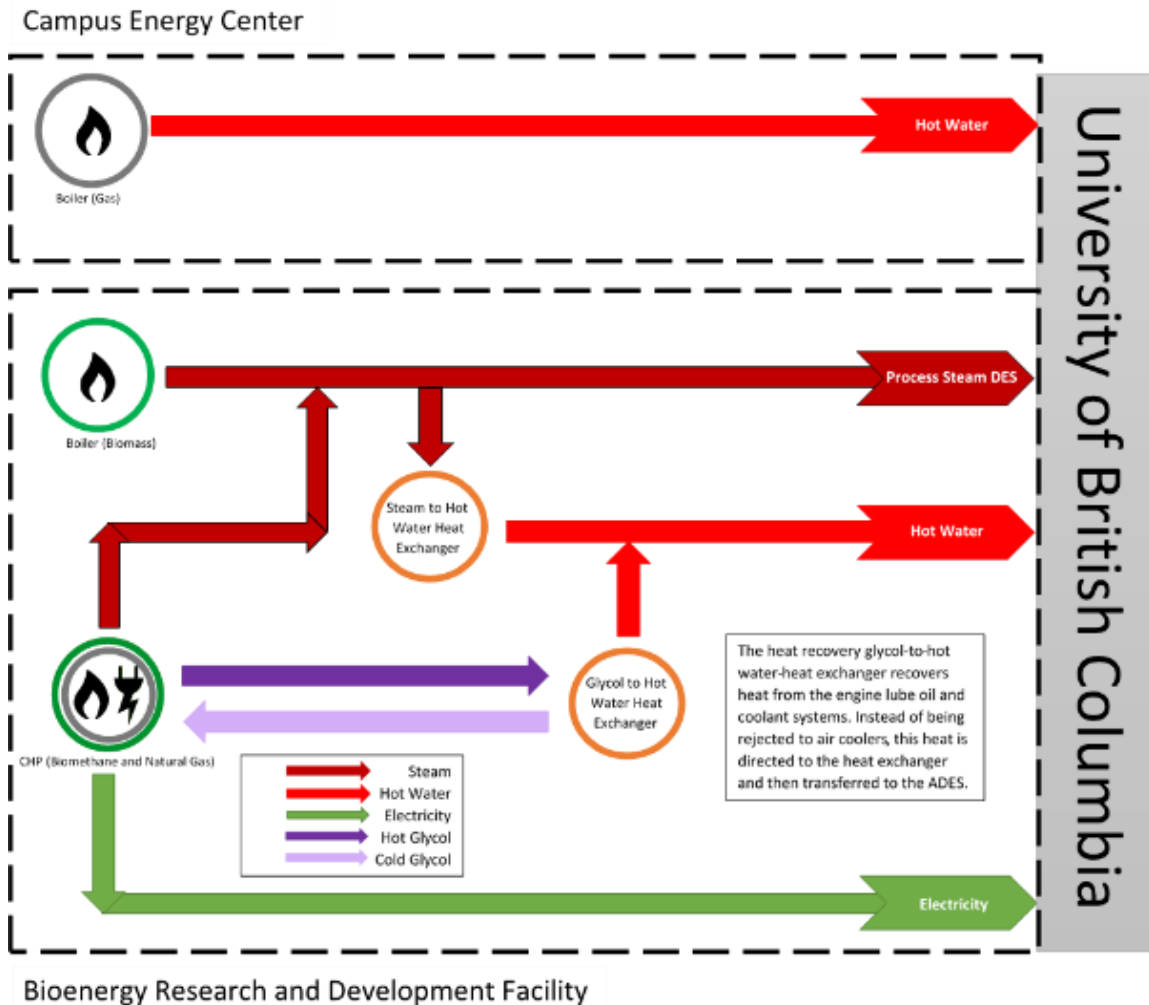

Figure 161. Energy system architecture of the Bioenergy R&D Facility.

### 6.31.4 Design and Decision Process

#### 6.31.4.1 General/Organizational Issues

Why was this project initiated, to answer which need?

*This project was initiated to reduce GHG emissions, achieve the targets in UBC's CAP, add resiliency and diversify UBC's fuel mix, and reduce operational and maintenance costs.*

Which stakeholders were involved in the project?

*UBC's Energy and Water Services, Project Services, Building Operations, Risk Management Services, Infrastructure Development, Campus Planning, Finance, Treasury, Legal Services, and Human Resources were involved in the project. In addition, FVB Energy, Dialog, KWL, Fortis BC, CES, CELCO, AME Group, AES, Siemens, Lockerbie & Hole, All Pro Services Ltd., LEDCOR, Tissling, Trotter & Morton, Division 15 Mechanical Ltd., Total Build, and Five Start were involved in the*

*project. Over 3000 people were employed from the previously mentioned organizations throughout the project:*

- *Nexterra Energy Corp. and GE Power and Water were involved in the BRDF project.*
- *Which resources were available before the project? What are local energy potentials?*
- *Before the project, the UBC Powerhouse supplied steam to heat academic buildings. It was first fired by coal in 1925 when constructed, and later fueled by natural gas. Locally, close to 1 million dry tonnes of waste wood is produced, with almost half of that amount not being used.*

Who (what) were drivers and who (what) were opponents (barriers) – and why?

*The following factors drove the conversion from the existing steam system to the new hot water system:*

- *The Powerhouse was the number one seismic risk on campus*
- *Aging steam infrastructure*
- *\$190 million in deferred maintenance*
- *In addition, the GHG reduction targets in UBC's CAP and carbon taxes in British Columbia were also drivers for the steam-to-hot-water conversion along with the construction of the BRDF. Furthermore, the BRDF as a living lab where research and operations would coexist was a driver of that project.*

What was finally the crucial parameter for go /no-go decision?

*The business case and technical evaluations all pointed to the requirement for UBC to convert to a hot water ADES. The crucial parameter for the first go/no-go decision was the announcement of UBC's 2010 Climate Action GHG reduction targets by the University President, Stephen Toope. After a pilot phase, expected carbon and energy savings were confirmed that facilitated the follow-up decision to carry on with the project.*

#### **6.31.4.2 Financing Issues**

In 2011, the Board of Governors (BOG) approved the CA\$88 million project in principle. A step by step approach with main funding approval contingent upon the pilot or phase 1 performance evaluation and verification was deployed. In 2012, phases 2 and 3 were approved. Stop No-Go or off ramp options were available up to phase 4, the construction funding approval for the Campus Energy Center. In 2013, Phase 4 was approved. Later in 2013, full funding of phases 5-10 were approved.

Which business model applies to the project?

*The project's business case justifies the capital of \$88m through commodity (natural gas, water), carbon, staff, and maintenance savings, as well as the capital avoidance of the powerhouse. The BRDF was justified through natural gas and carbon savings alone.*

### 6.31.4.3 Technical Issues

What have been major technical challenges/constraints regarding system design?

*A major challenge was the transition period between using steam and hot water. To solve this, a Temporary Energy Centre (TEC) was developed to provide additional capacity while the CEC was being built over 2 years. This enabled 85 building conversions to be completed before the CEC coming into service.*

### 6.31.4.4 Design Approach Applied

Which design targets have been set and why?

*The CEC is designed with a host of future expansion expectations in mind. It includes four boiler bays, each large enough for a 75-MMBtu/hr unit, as well as space to add a 25 MW cogeneration plant (75 MMBtu/hr hot water capacity) in 5 to 10 years.*

Which decision steps/workflow lead to the retained solution?

*Post-design phase, implementing the Termis District Energy optimization software has given UBC the ability to see the whole DES system, plant, distribution, and energy transfer center, in real-time. It also produced what-if scenarios, expansion planning, and pressure and temperature optimization.<sup>6</sup>*

### 6.31.5 Resilience

Which threats were considered and are to be considered? Are there redundancies in the energy supply system? Are there backup systems? On which time-scale can they be accessed?

*The number one seismic risk on the UBC Vancouver campus was the steam power house. Its decommissioning in 2017 eliminated a significant risk to UBC's infrastructure system. The steam powerhouse was replaced by the combination of the CEC in the fall of 2015 and the BRDF in the fall of 2012, both designed for post-disaster.*

*UBC's Steam to Hot Water Conversion Project demonstrates an innovative approach to infrastructure management, and leverages cyclical maintenance investment to achieve multiple sustainability objectives. The project has eliminated \$190 million in deferred maintenance costs, reduced operating costs, improved safety and resiliency, and dramatically reduced energy and water consumption.*

#### 6.31.5.1 N+1 Redundancy

Many of UBC's systems have N+1 redundancy (i.e., backup) features, which offer resilience. For example, during recent wind storms in January 2018, one transmission line was kicked out twice during a 10-day period due to felled trees. UBC campus did not experience an outage due to a fully redundant second transmission line.

### 6.31.5.2 Diversification of Fuel Sources

In the past, UBC had been 100% reliant on utility providers for electricity and natural gas, but today, thanks to cogeneration and the use of biomass, nearly a third of the campus' energy can be provided through other means. UBC's ADES has multiple fuel options including natural gas, fuel oil, renewable natural gas, and biomass. UBC's biomass and cogeneration facility produces steam that can be used in the, soon to be fully shut down, process steam legacy grid or be fully converted to hot water for the campus hot water system.

### 6.31.6 Lessons Learned

#### 6.31.6.1 Major Success Factors

What the UBC got right:

- Phase 1 pilot
  - Allowed for lessons learned to be incorporated into later phases
  - **Verified** costs estimates and delivered energy and cost **savings** from phase 1 onwards
  - Confirmed original business case assumptions e.g., existing steam piping was found to be very **poorly insulated**
- Carbon pricing (to date)
- Energy savings on pace for 280,000 GJ/year savings
- Links with public realm improvements and new construction
- New campus energy center location
- New campus energy center staffing requirements
- ETS cascading for domestic hot water
- Lower operating temperature
- CEC has expandability to meet all future thermal load growth for the ADES and NDES
- Open dialog with peers (IDEA).

#### 6.31.6.2 Major Bottlenecks/Major Lessons Learned

What the UBC Missed:

- Transition period. What to do with new buildings that cannot connect to hot water (is not ready) yet should connect to steam (being eliminated)
- Economies of scale impact of a 24% efficiency improvement. Rate structure was not split between fixed and variable. So, the 24% reduction impacted our ability to recover our fixed costs.
- The other side of the meter, cold mechanical rooms. An unexpected 10% savings.
- Process steam scoping. Several labs and or process requirements not captured under original scoping.
- Growth. We thought new buildings would be more energy efficient.

## 6.32 Energy Planning for Military Town Fort Bragg, USA

Case No.	Country	Location	Specific Type	Photo	Special points of attention
32	USA	Fort Bragg	Campus Military Town		 <p>critical infrastructure, heat pump, thermal storage</p>

This content is taken from Urban et al. (2020).

### 6.32.1 Installation Background

Fort Bragg is located in Cumberland County, which lies between the Sandhills and Coastal Plain regions of North Carolina (Figure 162.). Projections from 2017 approximate there are 10,273,419 residents in North Carolina, and by 2030, it is projected there will be 12 million. The region where Fort Bragg lies takes up 45% of the state's total land area and is mostly made up of wetlands. Population estimates indicate that Cumberland County has over 300,000 residents, and that the installation itself contains 145,092 residents. The region has also been subject to several localized droughts over nearly 2 decades, but it has not prevented Fort Bragg's ability to meet Army water use reduction targets.

Fort Bragg identified a need to update the current energy and water security plans to comply with new DoD directives regarding energy and water security and resilience. Updated plans were required to integrate and contribute to the sustainability and resilience goals at Fort Bragg, and to consider the interconnections between critical infrastructure systems (energy, water, wastewater, etc.) and the installation's ability to complete its mission and maintain readiness now and into the future.

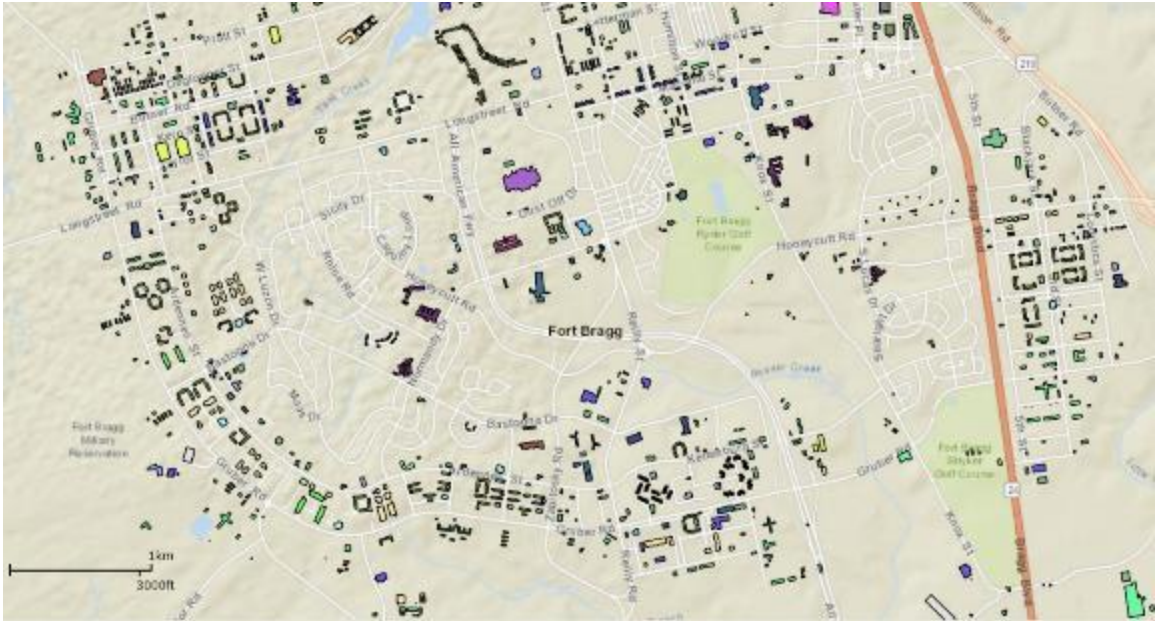

**Figure 162. Overview of Fort Bragg.**

### **6.32.2 Goals and Strategies**

The objective of this project was to evaluate and improve energy and water security at Fort Bragg, North Carolina through development of an IEWP. After determining the projected future energy and water needs of the installation in the baseline case, the energy and water consumption and management is compared with the installation's initial planning vision and goals; possible alternatives are developed for addressing the identified gaps. The analysis quantifies the energy savings needed to meet the goals and produce savings, as well as identifying the constraints and opportunities inherent in each alternative.

### **6.32.3 Development of the Baseline**

Infrastructure is interdependent on other critical and high-use systems, such as water infrastructure, electric power, and transportation systems. Failures in any one system can create a cascade effect, causing an increase in vulnerability to other infrastructure. In the baseline phase, the installation's current energy and water use, resource availability, system operations, missions, and tenants were identified. This baseline was created from the installation's real property inventory (RPI), resource consumption data, energy and water profiles, modeling outputs, and the evaluation of the existing state of the utility's infrastructure. Individual buildings were then combined into facility groups based on properties that affect energy and water use, such as facility function and age. Figure 162 displays a visual representation of the RPI and facility groups that were uploaded in the modeling tool.

Through a year-long process, mission-critical facilities were also identified through discussions with stakeholder organizations on post. Four categories were ultimately determined: Life, Health, and Safety; Command and Control; Deployment; and Life Support. Total demand for

water required was then determined and calculated at over 100,000 gallons per day. The calculated EUIs included:

1. Number of Facilities: 1,621
2. Total Conditioned Area: 36,533,928 sf (339,411,151 m<sup>2</sup>)
3. Site Electricity: 674,984,396 kWh (2,429,943,826 MJ)
4. Site Electricity Intensity: 63.04 kBtu/sf (715,915,651.2 J/m<sup>2</sup>)
5. Site Gas: 15,436,431 therm or 461,481,979 kWh (1,628,543,471 MJ)
6. Site Gas Intensity: 43.10 kBtu/sf (489,466,443 J/m<sup>2</sup>)
7. Energy Cost: \$44,796,048/yr
8. Total Site Energy: 1,136,466 MWh (4,091,277.6 gigajoule)
9. Total Site Energy Intensity: 106.14 kBtu/sf (1,205,382,094 J/m<sup>2</sup>).

## **6.32.4 Innovative Approach in Modeling Resilience**

### **6.32.4.1 System Master Planner/Net-Zero Planner Tool**

The System Master Planner/Net-Zero Planner (SMPL/NZP) Tool is a web-based modeling tool that provides an installation-wide overview of energy, water, and waste planning capabilities. By analyzing baseline and future priorities with this tool, better use and optimization of supply, load, and cost savings capabilities can be achieved.

For Fort Bragg, the model first extracts historical data to determine typical energy use for each facility based on a number of inputs (i.e., age, function, and conditioned area of each building and climate of the installation). The baseline calibration step then adjusts the calculated predictions to better represent the actual usage based on utility bills and consumption reports collected in the Army Energy and Water Reporting System (AEWRS). It should be noted that installation-wide consumption data may not match the model exactly, since the study may include a slightly different set of facilities and there is limited building-level metered data available for calibration. This calibration step, however, ensures that the model is valid for planning level analysis.

Figure 163 shows the energy breakdown by percentage and provides the basis for a comparative analysis of the baseline monthly electricity and natural gas distribution. The end uses for the building are shown with energy consumption for building internal equipment loads, domestic hot water, and lighting. The energy to condition the building is then shown with large amounts for heating, cooling, and ventilation (Fan Energy). Figure 163 shows that the heating load is in two components (1) building heat and (2) domestic hot water (or water systems).



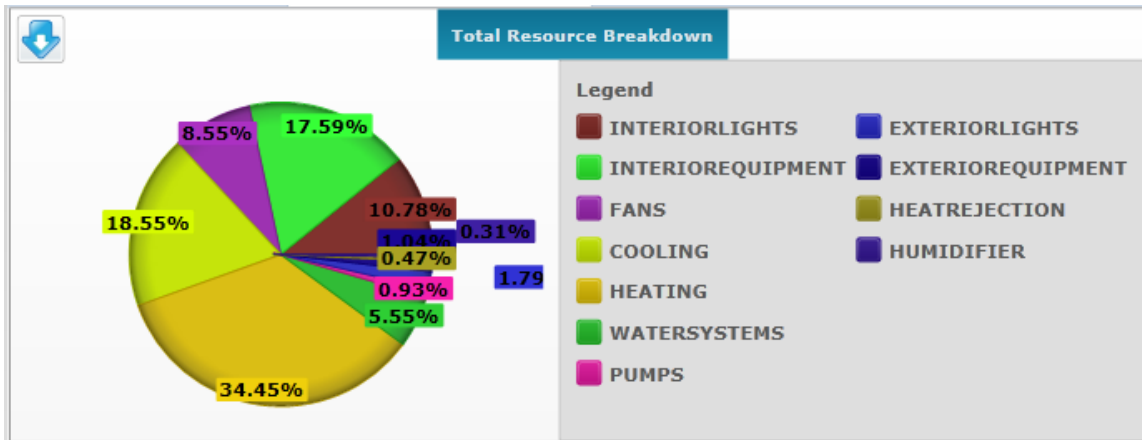

Annual Total: 1,136,466,432 kWh

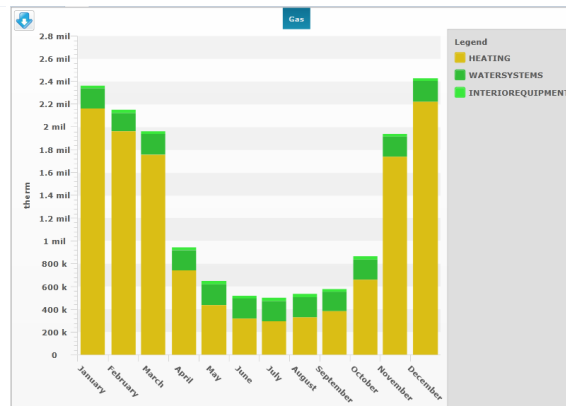
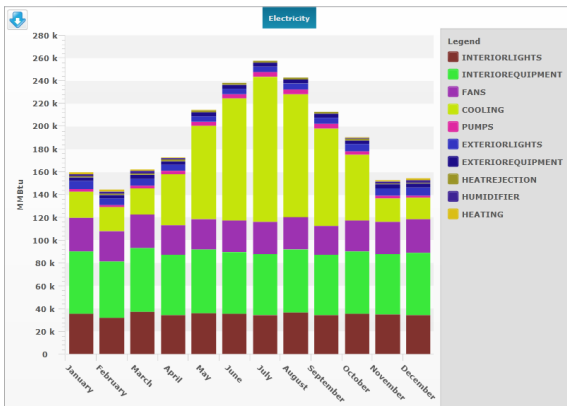

Figure 163. Energy breakdown of baseline energy and natural gas distribution (Source: SMPL/NZP, U.S. Army Corps of Engineers).

### 6.32.4.2 Energy Resilience Analysis (ERA) Tool

The ERA Tool, which was included in the baseline and future scenario modeling, was assessed during the Fort Bragg study to better determine the utility of the tool and to enhance the capabilities of SMPL/NZP. The ERA tool was developed by Massachusetts Institute of Technology Lincoln Laboratory [MIT-LL] specifically to support DoDI 4170.11(DoD 2009). As intended, the automated framework tool provides energy and planning personnel with the ability to perform energy resilience assessments with a focus on availability and reliability of energy LCC comparisons. The current ERA methodology has the following high-level steps:

1. Define the baseline (existing) energy architecture in the ERA Tool.
2. Define alternative energy architectures (this step is automatic in the Web App version).
3. Compare the baseline energy architecture to the alternative energy architectures to determine the architecture that is the best option.

At Fort Bragg, the ERA Tool was tested with the electrical infrastructure and then again with a combination of the electrical and thermal infrastructure. By adding thermal in the second run, the ability to see the impact of the outputs became a factor. Of the first nearly 40 architectures that were analyzed, 10% stood out from the baseline in reduction of factors such as costs and

resilience. In the second run, over 60 alternative architectures for both electrical and thermal were analyzed. The incorporation of the thermal central boilers with the same 10% having the lowest lifecycle costs showed that those architectures previously identified resulted in an increase of 15% in lifecycle costs compared to the existing onsite system. The bar chart in Figure 164. shows that the alternative architectures, which are 43% to 52% more effective in reducing energy than the existing systems, have the same in effectiveness as the electric-only versions.

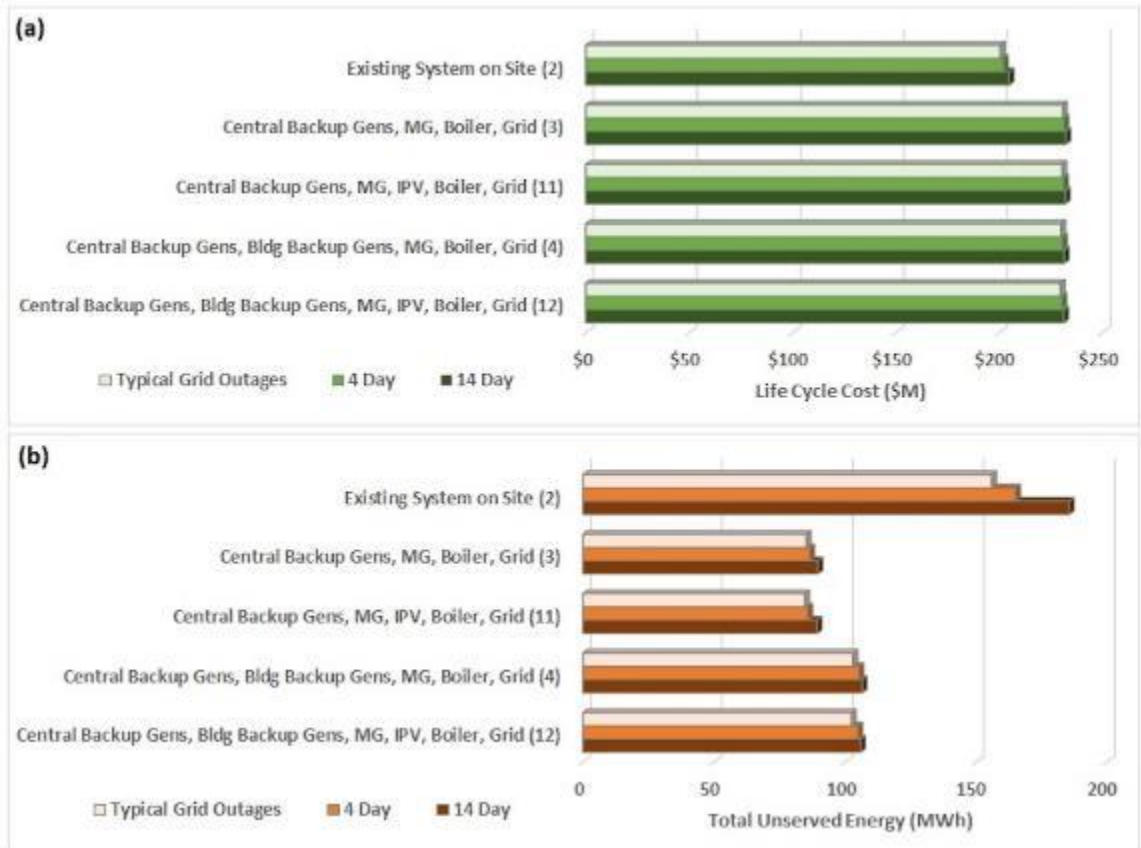

**Figure 164. (a) Life cycle cost and (b) unserved energy of various electrical and thermal alternative architectures for typical grid outages, along with 4-day and 14-day black sky outages.**

### 6.32.5 Establishing the Base Case and Future Alternatives

After developing the energy and water baseline, the future base case is then established. The base case is a future “business-as-usual” scenario that includes existing and planned facilities, but excludes facilities scheduled for demolition. Similar to developing the baseline, the development of the base case and future alternatives involves careful coordination efforts with installation resources. The installation’s master planning portfolio is taken into consideration, to include any planned or programmed energy and water projects. The base case projects the total installation annual and peak daily energy and water needs to meet the facility portfolio. The base case provides a gauge to which other potential future scenarios can be compared when determining the preferred course of action.

Once projected future energy and water needs are determined in the base case, the energy and water consumption and management is compared with the installation’s initial planning vision and goals. Possible future alternatives are then developed to address any identified gaps. The analysis quantifies the energy savings needed to meet the goals and produce savings, as well as identifying the constraints and opportunities inherent in each alternative. The various courses of action were reviewed with the stakeholders, and a preferred alternative was chosen. Table 68 lists the energy efficiency measures (EEMs) that were evaluated for the facility groups.

**Table 68. EEMs evaluated for the facility groups.**

<b>Package Name</b>	<b>Goals to Increase HVAC Efficiency</b>	<b>Example Measures to be Taken to Achieve Package Goals</b>
Lighting Package	Reduce Lighting Power Density (W/sf)	<ul style="list-style-type: none"> <li>● High-efficiency electric lighting. Replace inefficient T-12 or incandescent lamps with higher efficiency T-8, T-5, LED, or compact fluorescent lamps.</li> <li>● Improve ballasts.</li> <li>● Minimize redundant or excessive lighting.</li> <li>● Installing advanced lighting controls such as occupancy sensors and timers</li> </ul>
Equipment Package	Reduce Equipment Power Density (W/sf)	<ul style="list-style-type: none"> <li>● Use high-efficiency, Energy Star® certified appliances and equipment with sleep or standby modes.</li> <li>● Minimize redundant equipment.</li> <li>● Reduce number of printers, refrigerators, personal heaters, etc.</li> </ul>
Infiltration Package	2. Reduce Air Leakage Rate (cfm/sf) 1. Implement Vestibule Entrances	<ul style="list-style-type: none"> <li>● Reduce infiltration with a tighter building envelope</li> <li>● Install continuous air barriers</li> <li>● Caulk and weather stripping to seal existing leaks</li> </ul>
HVAC Package	3. Increase Chiller Coefficient of Performance (CoP) 1. High-Efficiency Boiler 2. High-Efficiency Pumps 3. Supply Temperature Reset Controls 4. Reduced Duct Leakage	4. Install high-efficiency chillers. 5. Upgrade high-efficiency boilers. 1. Install Condensing boilers. 2. Install high-efficiency boilers. 3. Install high-efficiency domestic hot water heaters. 6. Install high-efficiency chilled and hot water pumps. 7. Supply temperature reset controls. 1. Install air system supply temperature reset controls. 2. Install hot water system supply temperature reset controls. 8. Reduce upstream and downstream duct leakage fraction to return plenum.
Daylighting Package	Install Daylighting Controls	<ul style="list-style-type: none"> <li>● Install Daylighting controls to automatically dim electric lights.</li> <li>● Install tubular daylighting devices and light shelves</li> </ul>
Cool Roof Package	9. Increase Roof Reflectance 10. Increase Roof Emittance	<ul style="list-style-type: none"> <li>● Install a white painted or granular coated metal roof</li> </ul>

Package Name	Goals to Increase HVAC Efficiency	Example Measures to be Taken to Achieve Package Goals
Envelope Package	11. Increase wall base cavity and continuous insulation (R-value) 12. Increase Roof Base Insulation (R-value) 13. Increase Slab Vertical Insulation (R-value) 14. Decrease Window U-Value 15. Decrease Window Solar Heat Gain Coefficient	<ul style="list-style-type: none"> <li>Improve insulation levels of roof, walls, floor, and windows</li> <li>Install tinted, double-pane windows</li> </ul>
Domestic Hot Water Package	Reduce Domestic Hot Water Usage (Gallons per Minute [GPM])	<ul style="list-style-type: none"> <li>Install low flow fixtures</li> </ul>

Each facility group was analyzed with the implementation of a collection of EEMs, while weighing factors such as implementation cost and energy savings. When selecting the EEMs, it is important to assess both the economic and sustainability impacts. Suggestions were made to improve energy and water efficiencies for the intended usage needs, which would save an estimated 1 billion kBtu (thousand British thermal units or  $1.13565E+16$  J/m<sup>2</sup>) per year and reduce costs by \$7.3 million in total annualized cost savings. It is necessary to assess both the economic and sustainability impacts to achieve a balance and to ensure that the installation achieved its end goals. Figure 165 shows an example cost optimization curve for a Battalion Headquarters building. The curve in Figure 165 clearly shows that if all EEMs, including the HVAC Package, are implemented, the installation will enjoy the greatest energy reduction while still reducing the annual cost as compared to not selecting any EEMs in the baseline.

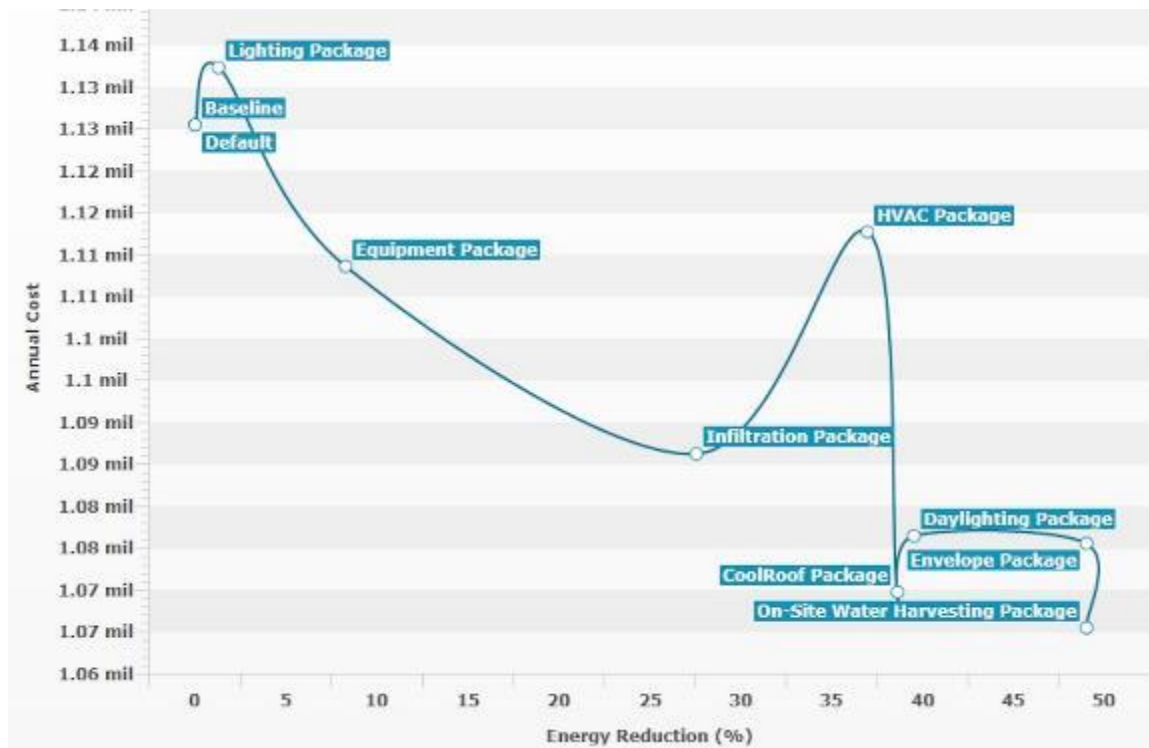

Figure 165. Cost optimization curve.

### **6.32.6 Measuring Resilience**

For critical missions, key buildings were identified with specific plans of action, cost benefit analyses, storage requirements, and minimum operation levels for essential emergency personnel. Operational efficiency of existing systems, including leak detection and repair on existing systems, was also identified as a resilience measure.

Specific hazards and threats were then divided into three categories: intentional (e.g., acts of terrorism or vandalism), unintentional (e.g., accidents or infrastructure failures), and natural events (e.g., hurricanes, floods, fires, etc.). Risks and vulnerabilities to critical mission energy and water systems were assessed, including supply resources, delivery networks, and end-use systems. Cyber incidents were of particular highlight.

By identifying BMPs for future studies, an outline has been created for measuring resilience to include program measures to reduce demand for energy and water, thereby increasing program efficiency, security, and identifying other resilience-enhancing measures.

Moving forward, the following BMPs were identified:



1. Set an overarching policy and goals for the long-term operating objective of the installation and its facilities.
2. Assess current energy and water uses and costs to establish a baseline.
3. Develop an energy and water balance through metering, auditing, and estimating consumption to compare the total supply baseline, determined in step 2, to end uses.
4. Assess efficiency opportunities and economics to identify retrofit, replacement, and maintenance options.
5. Develop an implementation plan, including education and outreach efforts for building occupants.
6. Measure progress and review goals.
7. Plan for contingencies, such as a drought, blackout or other emergency scenarios.

### **6.32.7 Lessons Learned**

Using the ERA Tool without existing SMPL/NZP baseline modeling was found to be potentially problematic. The baseline architecture did not initially include resilience measures required by the mission. For example, there may be no alternatives that have both a lifecycle cost and annual unserved energy that are lower than that of the baseline architecture; however, the baseline architecture may still not be resilient enough to sufficiently protect critical infrastructure from power failures. In this example, the ERA Tool alone would suggest that the installation keep its current insufficient infrastructure.

To rectify this issue, the team found that the combined tools could be configured to establish a base case in addition to the baseline. In installation master planning, the concept of a base case is the baseline plus any improvements planned to meet a minimum requirement. For example, an installation may have 10 existing buildings in their baseline, but they might need two more buildings over the next 5 years to accommodate an expected increase in personnel. The 5-year base case would then have 12 buildings.

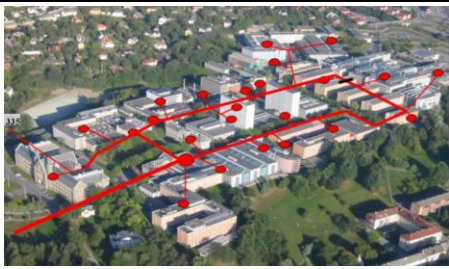
### 6.33 Future Energy Pathways for NTNU Gløshaugen Campus, Norway

Case No.	Country	Location	Specific Type	Photo	Special points of attention
33	Norway	Trondheim	Campus University		 <p>critical infrastructure, district heating, heat pump, solar and renewable sources</p>
<b>Country:</b> Norway <b>Name of city/municipality/public community:</b> Trondheim <b>Title of case study:</b> Future energy pathways for NTNU Gløshaugen campus considering possibilities for energy efficiency improvements <b>Author name(s):</b> Yiyu Ding, Natasa Nord <b>Author email(s):</b> <a href="mailto:yiyu.ding@ntnu.no">yiyu.ding@ntnu.no</a> , <a href="mailto:natasa.nord@ntnu.no">natasa.nord@ntnu.no</a>					
Link(s) to further project-related information/ publications, etc.: <a href="https://www.sciencedirect.com/science/article/abs/pii/S0378778816303164">https://www.sciencedirect.com/science/article/abs/pii/S0378778816303164</a> <a href="https://fmezen.no/wp-content/uploads/2018/06/ZEN-Report-no-2.pdf">https://fmezen.no/wp-content/uploads/2018/06/ZEN-Report-no-2.pdf</a> <a href="https://www.ntnu.edu/campusfuture">https://www.ntnu.edu/campusfuture</a> <a href="https://ntnuopen.ntnu.no/ntnu-xmlui/handle/11250/2629121">https://ntnuopen.ntnu.no/ntnu-xmlui/handle/11250/2629121</a> <a href="https://ntnuopen.ntnu.no/ntnu-xmlui/handle/11250/2562777">https://ntnuopen.ntnu.no/ntnu-xmlui/handle/11250/2562777</a> <a href="https://ntnuopen.ntnu.no/ntnu-xmlui/handle/11250/2562284">https://ntnuopen.ntnu.no/ntnu-xmlui/handle/11250/2562284</a>					

#### 6.33.1 Background and Framework

NTNU Gløshaugen campus (Figure 166) is the main campus of the Norwegian University of Science and Technology, which is located 2 km southeast from the center of Trondheim, Norway. The university campus consists of a group of different building types and functions, as well as different building age cohorts. It gives the possibility to compare it with “small city.”

The main target of the case study is to determine whether the building stock at NTNU Gløshaugen campus is able to become a Zero Energy/Emission Neighborhood towards 2050. One of the ZEN Centre’s pilot projects is “Knowledge Axis Trondheim,” which encompasses a high concentration of knowledge institutions, where NTNU Gløshaugen campus is situated. Currently, Gløshaugen campus consists of 46 buildings (Figure 167), which are divided into four building age cohorts (Table 69). The total gross area is about 300,000 m<sup>2</sup>. During the modeling period of 2017 to 2050, there is planned relocation of other parts of NTNU to the main campus area (Figure 168); therefore, the Gløshaugen building stock is expected to grow substantially until 2025. The planned campus expansion is included in the Campus Development Project. These new buildings should fulfill the requirement of nearly zero emission buildings, meanwhile the energy efficiency in the existing buildings should be improved.

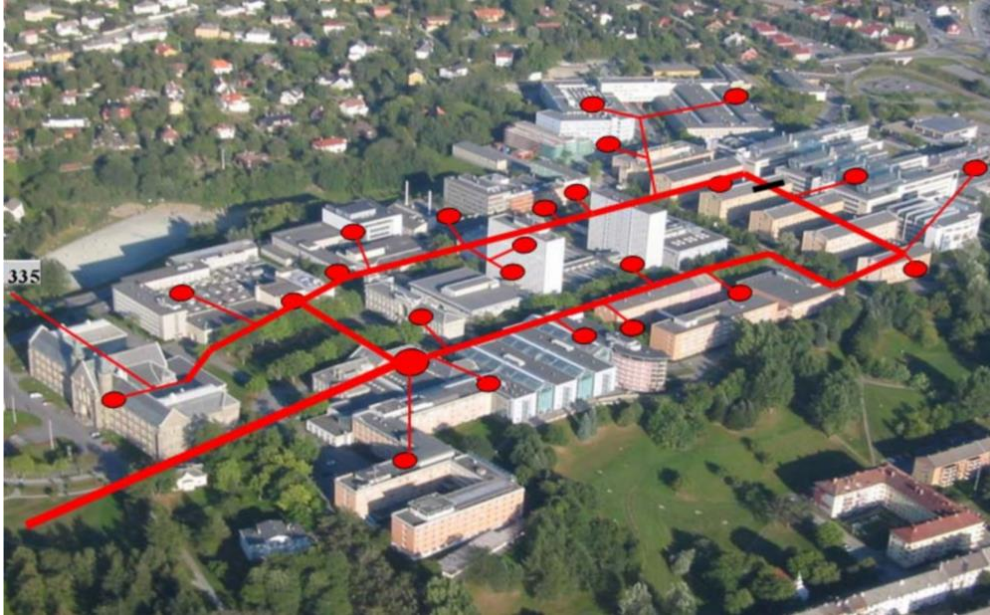

Figure 166. View on the NTNU Gløshaugen campus. The red lines are campus district heating ring with the red dots as consumer substations.

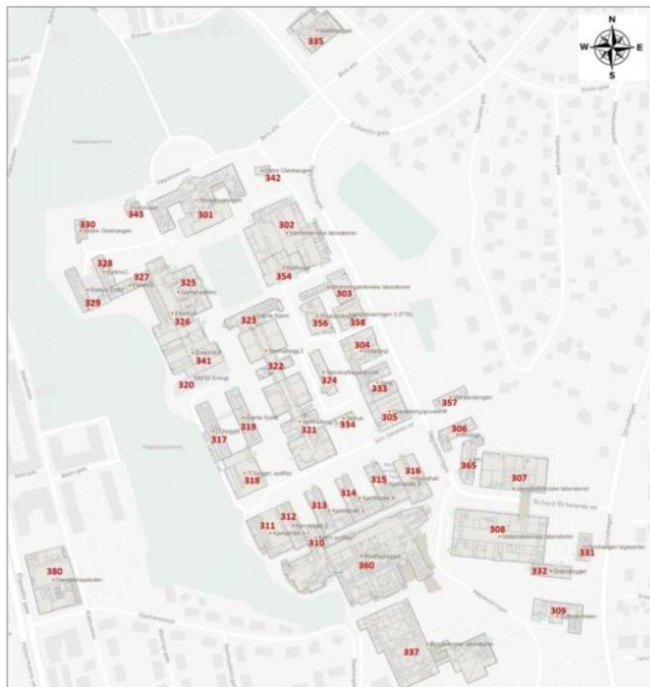

Figure 167. Current building stock of NTNU Gløshaugen campus.



**Figure 168. Future development plan of NTNU Gløshaugen campus (NTNU’s campus development).**

Users are the students and employees of the NTNU Gløshaugen campus (see Table 70). The campus is served by Norwegian power grid (medium voltage) and DH. The local DH utility company supplies the main heat source, which is distributed by campus own DH ring (Figure 166). In addition, waste energy recycled from IT center on campus provides constant heat. The energy use data is collected from the campus energy monitoring system.

**Table 69. Cohort groups of buildings based on construction years.**

<b>Cohort group</b>	<b>Number of buildings</b>	<b>Number of protected buildings</b>	<b>Gross floor area (m<sup>2</sup>)</b>	<b>Net floor area (m<sup>2</sup>)</b>	<b>Number of reference model</b>
before 1951	8	8	38,692	31,630	B1
1951- 1970	26	1	156,452	138,036	B2
1971- 1999	9	—	58,915	51,763	B3
2000- 2020	3	—	85,046	76,117	B4
2020- 2025	8	—	92,000	80,684	B5

Energy objectives are:

- Reduction of energy demand under campus growth
- Use of local sources (waste heat, solar PV)
- Economically and Environmentally sustainable energy provision
- Energy Performance Targets defined by energy certifications together with the Norwegian national standards.



**Table 70. Information table on NTNU Gløshaugen campus.**

<b>General quantitative information:</b>	
<ul style="list-style-type: none"> <li>• Heating demand and electricity demand per m<sup>2</sup> varies among different building functions</li> <li>• Total annual heating demand and electricity demand are 30 343 MWh and 60 070 MWh, respectively</li> <li>• Indoor temperature between 21 and 23 °C</li> <li>• Ventilation air supply temperature is set between 18 and 19 °C depending on outdoor temperature</li> <li>• Supply/ return temperature of radiator are 80/ 60 °C</li> </ul>	
<b>Additional information:</b>	
<b>Building mix in the area*:</b>	300 000 m <sup>2</sup> , 100% educational use including offices, labs, lecture halls, study rooms, libraries, etc.
<b>Consumer mix in the area**:</b>	100% large consumers
<b>Energy plant owner (public or private):</b>	University self
<b>Thermal energy supply technologies***:</b>	District heating from utility company, ammonia heat pump to harvest the waste heat from the IT center
<b>Electric power supply technologies***:</b>	mostly from the public power grid, installation of PV panels both on existing and new campus buildings
<b>Thermal energy production from heat pump:</b>	20% to 60% of annual heat need under different efficiency packages
<b>Ventilation system:</b>	Combination of units with CAV and VAV
<b>Heat recovery efficiency and SFP:</b>	55% and 2.64 W/(m <sup>3</sup> /s)
<b>U-Value of outer wall:</b>	0.4- 0.6 W/(m <sup>2</sup> ·K)

EEMs were combined into four packages of measures: (1) standard renovation of building envelopes, (2) ambitious renovation of building envelopes, (3) technical and operational improvements, and (4) combination of the last two packages. Table 71 summarizes the established package measures. These packages aimed to reveal the potential for the implementation of various energy supply technologies for campus energy system. Technical Management Section notified that some buildings already have made the transition to the fourth generation of district heating (4DH), a P4 package aimed to implement ambitious and technical considerations simultaneously.

**Table 71. Establishment of EEMs.**

Package		Building Envelope	Energy Efficiency Measures
P1: Standard package		Outer walls 1	Insulation with 50 mm mineral wool
		Roof	Insulation with 50 mm mineral wool
		Windows 1	TEK17 level (U-value 0.8 W/(m <sup>2</sup> ·K))
		Air tightness	Improvement of leakage rate to 1.5 l/h
		Thermal bridge	Improvement of thermal bridge to 0.06 W/(m <sup>2</sup> ·K)
P4= P2+P3	P2: Ambitious package	Outer walls 2	Insulation with 100 mm mineral wool
		Roof	Insulation with 50 mm mineral wool
		Windows 2	Ambitious level (U-value 0.6 W/(m <sup>2</sup> ·K))
		Air tightness	Improvement of leakage rate to 1.5 l/h
		Thermal bridge	Improvement of thermal bridge to 0.06 W/(m <sup>2</sup> ·K)
	P3: Technical package	Heat recovery ventilation	Replacement of heat recovery with 80%
		Low temperature heating system	Switch from 80/60 °C to 60/40 °C system

Two scenarios were introduced to analyze possible developments of the campus: the baseline scenario and the advanced renovation scenario. The *Baseline scenario* considered that the future development of the existing and new buildings would follow current trends. This means that the renovation activities and new buildings would happen in compliance with present policy and regulations. The existing building stock was assumed to undergo standard renovation in a 40-year renovation cycle. The new buildings were expected to be built according to passive-house requirements. *Advanced renovation* prioritized increased energy efficiency of the building stock. This meant that the existing buildings were expected to undergo advanced renovation, whereas the new buildings were presumed to be built according to passive-house requirements. At the same time, to reduce the energy import, *Extensive local energy production* scenario concentrated on generating energy from renewable sources within NTNU Gløshaugen campus. The increasing use of HPs, PVs, and a biogas-based CHP was expected to make campus less dependent on the energy grid. The *hybrid scenario* is a combination of *Extensive local energy production* and *advanced renovation* scenarios. *The hybrid scenario* is the most ambitious from all the presented development paths and is characterized by the highest chance to meet a Zero Energy/Emission balance at neighborhoods level. Energy export to the grid is likely feasible. The data in Table 72 describe the analyzed scenarios under different assumptions of renovation activity and energy supply systems. Table 72 and Figure 169 present the detailed description of findings related to energy use development and renovation packages for each cohort group. The results show that P4 energy-saving package provides the highest savings when it comes to heating use since P4 is based on combination of the most effective energy-saving measures (Table 73).

**Table 72. Scenario specification.**

		<b>Base line</b>	<b>Extensive local energy production</b>	<b>Advanced renovation</b>	<b>Hybrid</b>
Existing buildings	Renovation (a 40-year cycle)	Standard	Standard	Advanced	Advanced
New buildings	Construction	Passive-house standard	Passive-house standard	Passive-house standard	Passive-house standard
Energy supply systems	Electricity supply	Electrical grid	Electrical grid	Electrical grid	Electrical grid
		PV on the new construction (60% of full potential)	PV on the new construction ( <i>full potential</i> )	PV on the new construction (60% of full potential)	PV on the new construction ( <i>full potential</i> )
			PV on the existing buildings (full potential) Biogas-based CHP	PV on the existing buildings (60% of full potential)	PV on the existing buildings (full potential) Biogas-based CHP
	Heat supply	DH HPs Waste energy from data center	DH HPs Waste energy from data center Biogas-based CHP	DH HPs Waste energy from IT center	DH HPs Waste energy from data center Biogas-based CHP

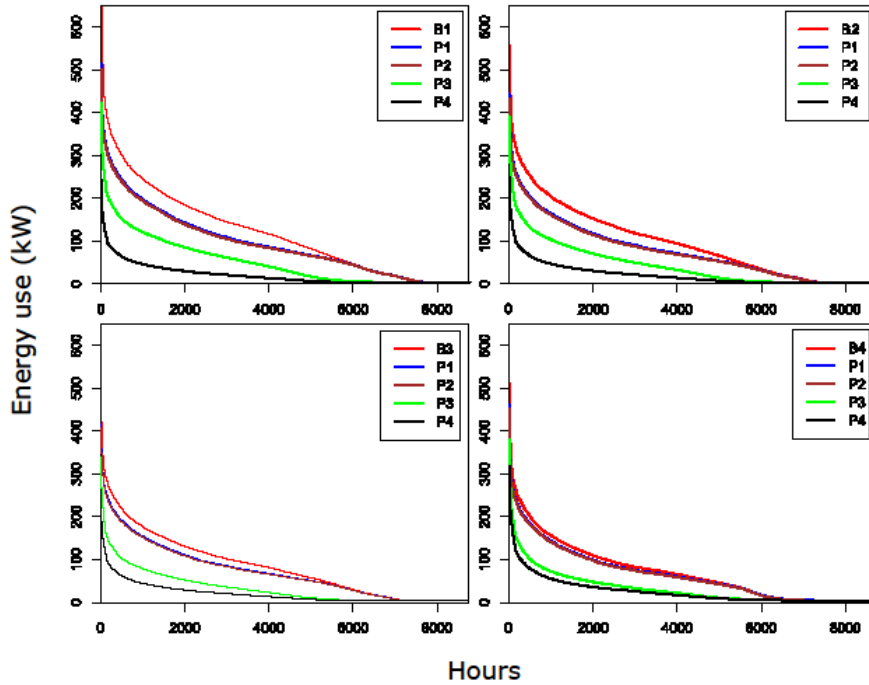

Figure 169. Heat duration curves for B1-B4 models under corresponding renovation packages.

Table 73. Specific heating energy use for B1-B4 models with introduced EEMs.

	<b>B1</b>	<b>P1</b>	<b>P2</b>	<b>P3</b>	<b>P4</b>
DH (kWh/m <sup>2</sup> )	150.1	116.4	114	63.4	26.3
Savings (kWh/m <sup>2</sup> )		33.7	36.1	87.6	123.8
Savings (%)		22	24	58	82
	<b>B2</b>	<b>P1</b>	<b>P2</b>	<b>P3</b>	<b>P4</b>
DH (kWh/m <sup>2</sup> )	119.6	95.4	93.2	53.9	27
Savings (kWh/m <sup>2</sup> )		24.2	26.4	65.7	92.6
Savings (%)		20	22	55	77
	<b>B3</b>	<b>P1</b>	<b>P2</b>	<b>P3</b>	<b>P4</b>
DH (kWh/m <sup>2</sup> )	104.2	90.2	88.3	41.9	26
Savings (kWh/m <sup>2</sup> )		14	15.9	62.3	78.2
Savings (%)		13	15	60	75
	<b>B4</b>	<b>P1</b>	<b>P2</b>	<b>P3</b>	<b>P4</b>
DH (kWh/m <sup>2</sup> )	83.8	81.2	79.7	40.4	32.1
Savings (kWh/m <sup>2</sup> )		7.1	8.6	47.9	56.2
Savings (%)		8	10	54	64

Figure 170 shows that heating energy use decreases gradually as a result of renovation activities. It can be further noticed that energy use would be less than 6 000 hours on annual basis. This is due to intensive use of waste heat use in campus area. Figure 171 shows the total energy demand with respect to cohorts. The results for two development scenarios are presented.

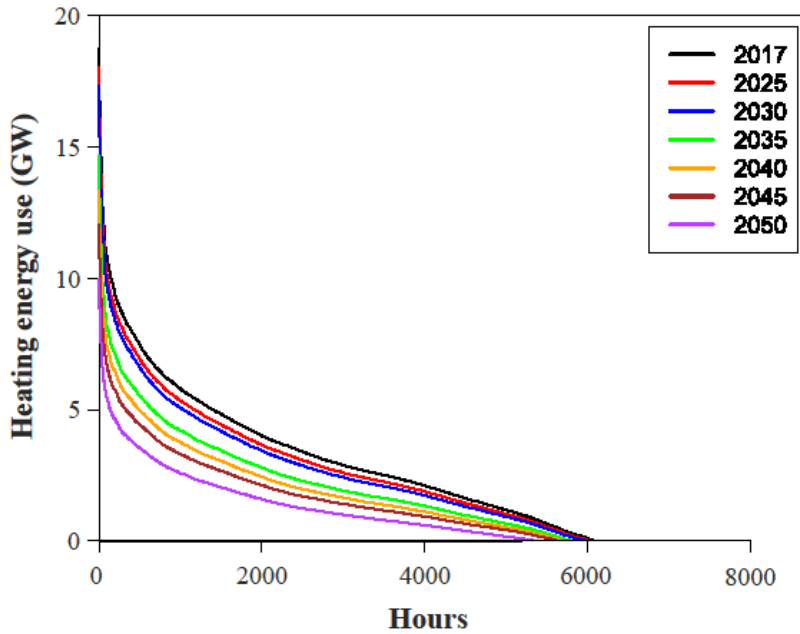

Figure 170. Development of heating energy use 2017-2050.

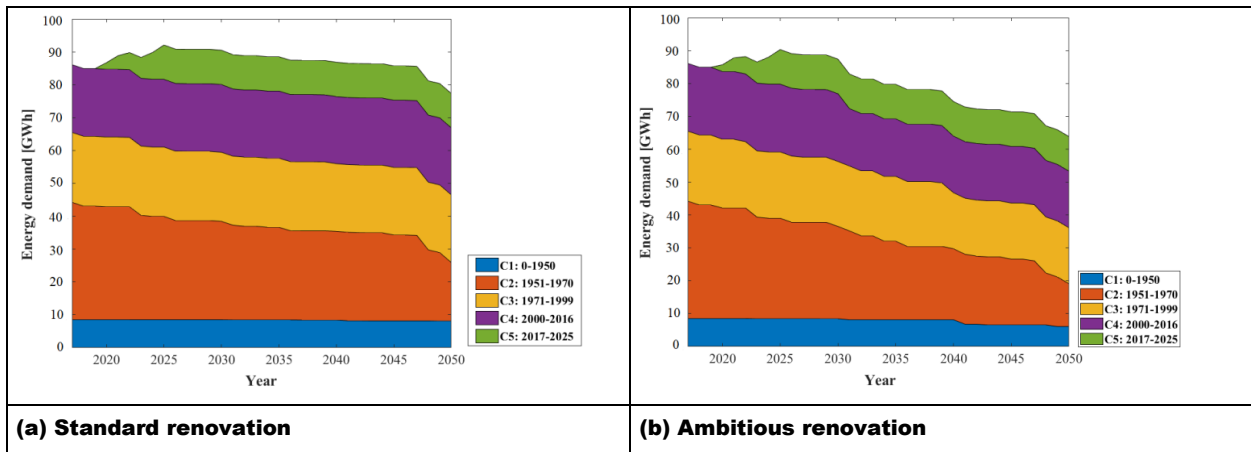

Figure 171. Energy demand with respect to cohort group.

### 6.33.2 Innovative Approach

The results on energy efficiency packages highlighted that saving potentials are largely dependent on the construction period of the buildings. It has been pointed out that, during the modeling period (2017-2050), only the buildings from the biggest cohort group 1951-1970 are expected to undergo demolition as they are one of the oldest buildings on NTNU Gløshaugen campus (apart from the buildings constructed before the year 1950, which are protected and cannot be demolished). The findings indicate that advanced renovation including extensive use of HPs is the most promising strategy for energy demand reduction by 26% and emissions by 54%. It will decrease not only energy demand and make NTNU Gløshaugen campus self-sufficient in heat supply, but also considerably reduce environmental impact. In addition, the use of waste heat is expected to reduce the heating duration time by 6,000 hours.

However, onsite local energy generation from PVs and a biogas-based CHP is proven to be limited and insufficient to cover a significant share of the total energy demand, particularly electricity demand. Considering relatively low carbon intensity of electricity from the grid in Norway, the savings from decreasing imports of electricity are expected to be relatively modest.

To summarize, the innovative technical aspects include:

- Use of waste heat from IT center
- Heating of buildings with low temperatures
- Extensive use of HPs
- Improvements in the ventilation system.

### 6.33.3 Decision and Design Process

#### 6.33.3.1 General/Organizational Issues

Why was this project initiated, to answer which need?

*The project was initiated by the building user and the building owner, who saw the importance to determine whether the building stock at NTNU Gløshaugen campus is able to become a Zero Energy/ Emission Neighborhood towards 2050. The Norwegian University of Science and Technology has a focus on sustainability and energy efficiency, and is active in the ZEN Centre's pilot project- Knowledge Axis Trondheim.*

Which stakeholders were involved in the project?

*The involved parties were owner (NTNU), research institute (ZEN Research Centre).*

Which resources were available before the project? What are local energy potentials?

*Local energy potentials are local waste heat, solar irradiance, wind conditions. Available resources include building skeletons of high-quality and useful structure, financial support, building operation team, and planning team experienced in integral planning.*

Who (what) were drivers and who (what) were opponents (barriers) – and why?

*The main driver for the process was the university's target to achieve a Zero Energy/ Emission Neighborhood towards 2050, under the substantial construction activities due to relocation. The main barrier for the process was the limited budget and research time to tackle the need for reliable high-quality solution. For example, the energy storage possibilities at NTNU Gløshaugen were not investigated.*

What have been the main challenges regarding decision finding?

*One important challenge was to find saving potentials for the high electricity demand. Since the campus is the mix of different building functions, it is challenging to define and model the electricity use, since it is driven by diverse experimental activities in the lab.*

What was finally the crucial parameter for go /no-go decision?

*The results found that NTNU Gløshaugen campus is far from becoming a Zero Energy/Emission Neighborhood in 2050. Despite a considerable decrease in heat demand and a substitution of DH*

*with low carbon heat technologies, the university campus remains heavily dependent on imports of electricity from the grid.*

### **6.33.3.2 Design Approach Applied**

Which design targets have been set and why?

*Additional design targets for innovative actions:*

- *Integral planning and analysis of alternatives*
- *Consideration of maintenance and operation, etc.*

*Technical:*

- *Air tightness ( $n_{50} < 1$ )*
- *Thermal bridges ( $\leq 0.06 \text{ W}/(\text{m}^2 \cdot \text{K})$ ).*

*Comfort:*

- *Light: check possibility for light guiding systems*
- *Light: homogeneous artificial light density at workplaces (lighting concept, simulation)*
- *Light and equipment following the Norwegian Standard NS 3031*
- *Thermal comfort in winter and summer (air- wall:  $\Delta T < 4\text{K}$ , air- window  $\Delta T < 6\text{K}$ )*
- *Acoustics: reverberation time following the Norwegian Standard NS 8178.*

Which decision steps/workflow lead to the retained solution?

1. *Data collection, reference building modeling*
2. *Establishment of EEMs*
3. *Development of BAU planning process & possible additional measures to reach higher standard, by following the Norwegian Regulation TEK 17 (standard) to more ambitious measures*
4. *Implementation of local energy sources*
5. *Energetical check of the outcome of the BAU and the effect of additional measures, using various tools, optimization*
6. *Comparison the most important factors and most promising strategies*
7. *Evaluation.*

### **6.33.3.3 Technical Issues**

What have been major technical challenges/constraints regarding system design?

- *The current EEMs have large potential to reduce heat demand and reliance on the DH, however these measures have little effect on lowering the high demand of electricity. This is because the buildings on NTNU Gløshaugen campus are not homogenous regarding floor area type. The class distribution is closely dependent on activities that take place in each building.*
- *There is need for more daylight use and natural ventilation that still maintain indoor temperatures on an acceptable level, even though thermal mass is limited.*
- *There is an overshadowing effect on the facade of Sentralbygg 2 caused by the shadow produced by Sentralbygg[1].*

What solutions have been considered for generation, storage and load management?

*The focus was on energy efficiency for heating. Heat is provided by DH from utility company and electric energy by the power grid. Possibility of PV on roof and wind potential was checked, and a biogas-based CHP was calculated.*

Which tools have been used during the design phase? Include name, originate (plus web link), purpose of the tool, specific use of the tool within the case study, practical experiences during application, cost/price (if commercial tool)

1. *Energy performance certificate according*
2. *IDA-ICE for dynamical building simulation (hourly energy use profiles)*
3. *PVsyst for evaluating energy generation from PV system.*

What have been the main challenges in the design phase?

*From the current results, it will be worthwhile to implement all measures if the costs are not considered. Considering the costs associated with rehabilitation, P1 will be more profitable than P2 for all reference models, and for Building model 4, P3 will be the only profitable package since the savings potential from phase renovation was small.*

What parameters are controlled via monitoring?

*Heat and power use of each building, total power for water pumps needed for heating, heat use in different heating circuits, power/heat for ventilation, power for lighting and user per level, power for elevator, laboratory, water, emergency power per building.*

#### **6.33.4 Resilience**

Resilience was targeted by installation of an uninterruptible power supply unit. One important issue is that, in this case, the district heating system (local utility company) and buildings (NTNU self) are not owned by the same entity, representing a challenge to the project team.

Which threats were considered and are to be considered? Are there redundancies in the energy supply system?

*Some situations are considered for each public building process, like blackout of general power supply system, blackout of internal power supply due to fire. There is an emergency power supply to feed emergency lighting and emergency ventilation. Resilience to other dangers was not an important topic in the renovation and new buildings process, and is not reported in the available reports on the project.*

What is the degree of autarky?

*Heat is expected to be self-sufficient.*

Which processes that require heat, cooling or power are there? Which ones are critical? (Order by priority). What is the possible timeout without imposing damage?

- *Exhaust ventilation of laboratories*
- *Exhaust ventilation of access areas/ staircases in case of fire*
- *IT center on campus (zero time out possible)*
- *Emergency lighting.*

Are there backup systems? On which time-scale can they be accessed?

- *Backup power supply units have been installed*
- *On the long term, there is the possibility to export the surplus heat to public district heating grid.*

## **6.33.5 Lessons Learned**

### **6.33.5.1 Major Success Factors**

Both tenant and owner have know-how on building, and were interested in achieving a high-level results.

Acquisition of appropriate financial subsidies allowed for developing and keeping track of non-standard procedures (integral planning, innovative measures, monitoring, LCC)

### **6.33.5.2 Major Bottlenecks/Major Lessons Learned**

- It is still challenging to reduce high demand of electricity on campus with limited local electricity generation
- Permanent monitoring and temporal monitoring do lead to similar costs.
- High-level criteria for energy efficiency and sustainability led to better than usual results.
- Although class distribution is closely dependent on activities in each building, the share of traffic area within all cohorts is relatively constant and accounts for c.a. 25% of total floor area.
- Heating saving potentials were highly dependent on the construction period of the building.
- Optimization variants (e.g., ventilation system as technical measure) should be defined and assessed in the preliminary phase.
- Real energy price (e.g., the peak load price) may give higher cost savings than modeled.
- For innovative technologies one needs to define:
  - Technical requirements for feasibility
  - Critical factors like error-proneness of control systems, space requirements
  - Conditions for cost effectiveness and cost drivers
  - Criteria for the RFP.
- Important issues for the demolition of educational and offices buildings built in 50s to 70s:
  - Largest building cohort on campus
  - By only demolishing this cohort during modeling period (2017- 2050) can largely reduce heat demand.

What should be transferred from this project?

- *Use integral planning to enable innovative solutions*
- *The Zero Emission Neighborhood model is suitable for analyzing future building stock, energy demand and GHG emissions of a neighborhood like NTNU Gløshaugen campus*
- *Consider monitoring already in the planning phase*
- *Complex use of electricity shall be studied further in (scientific and technological) university campus*
- *The reduction of heating demand and extensive local heat production can not only reduce heat import but also reduce the GHG emissions since low carbon energy sources are used*



## CHAPTER 7. METHODOLOGY

This chapter discusses the methodology used to obtain the case studies described in this book.

### 7.1 Goals

The goal was to find, document, and analyze best practice cases of energy master planning for public communities that could serve as examples to learn from. Cases from different countries and with different critical functions and needs were to be described, to contribute a broad variety of cases that is represent real-world conditions. The gathered information needed to include drivers, energy goals and success factors, barriers and lessons learned, as well as technological and organizational procedures and solutions, and details on the energy system including consumption, production, storage, and conversion.

### 7.2 Template

To achieve the goals and allow for comparable documentations of all case studies, a template was created. The template was based on the template used in IEA-SHC task 52, which focused on planning for solar thermal applications in urban environments. The template was augmented to serve the needs of Annex 73 “Towards Net-Zero Energy Resilient Public Communities,” e.g., with questions on resilience and on building energy use as well as power supply. The idea was to use a template that asks mainly for qualitative descriptions and text, due to the high variability of case studies that we expected, ranging from single buildings, over system components to energy systems of whole towns. Asking mainly for numeric data would have led to a need for a great deal of supplemental explanation. To encourage a certain level of similarity between case studies, a model case study was prepared to serve as example for all people working on case studies.

The following details are asked for in the template:

- Information regarding Author and References
- Schematic figure or aerial overview
- Introduction und description
- Project Fact Box
- Description of a technical highlight/innovative approach
- descriptive graph of the energy supply system
- Decision and design process
- Resilience
- Lessons learned.

The template is provided as Appendix A.

### 7.3 Selection of Appropriate Cases

The goal was to study cases of energy master planning, preferably of public communities. The state of the case was left open, i.e., it could be cases where actions were already implemented, but also cases where planning was still at early stage.

Each country that participated in Annex 73 on “Towards Net-Zero Energy Resilient Public Communities” was requested to contribute cases.

- Australia has contributed two case studies on university campuses. In these cases, the aim was to reduce peak loads. The goal is reached by efficiency measures and by district cooling systems with thermal storage.
- Austria has contributed two case studies on university campuses. One of them examines the renovation of a small campus, with main focus on building envelope and building services. The other examines the creation of a totally new campus, using local resources and available supply systems
- Different teams from the United States have contributed case studies, some of them on military campuses, others mainly on university campuses. These studies mostly examine the process of planning for adaptation of energy systems, to increase efficiency, resilience and reliability.
- Denmark has a long tradition of integrated planning for heat supply. Danish teams have studied cases of district heat and cold supply systems, with a focus on integration of waste heat and heat from ambient/solar sources, as well as on the integration of neighboring supply systems. The main goal is to add source flexibility to reduce costs and include renewable heat.
- Finland has contributed case studies on combined heating and cooling systems, with a focus on the use of heat pumps and large storage opportunities. Another case study shows a possible active role of buildings in energy systems.
- Germany has contributed one case study on transforming a university campus towards low consumption and low carbon. Other cases investigate the concluded transformation of public buildings and their supplying energy systems.

The organizations that have been involved in case studies are listed here:

- Australia
  - Melbourne School of Engineering
- Austria
  - AEE Institute for Sustainable Technologies
  - BIG GmbH
- Canada
  - University of British Columbia
  - Concordia University

- Denmark
  - Aalborg University
  - Ramboll
  - Danfoss A/S
- Germany
  - Klimaschutz- und Energieagentur Baden-Württemberg (KEA)
  - Institut für Ressourceneffizienz und Energiestrategien (IREES)
  - Hochschule für Technik Stuttgart (HFT)
- Finland
  - VTT
- Norway
  - Norwegian University of Science and Technology
- USA
  - US Army
  - International District Energy Association (IDEA)
  - Department of Energy (DOE)
  - University of California, Davis (UC Davis)
  - University of Texas at Austin (UT Austin)
  - Denver Government
  - St. Paul City Planners

The case studies were done from 2018 to 2020. They examined processes have different time scales, ranging from recent planning and implementation processes to energy systems that have evolved over many decades.

## 7.4 Case Study Process

In each country, teams were formed to study and document their cases using the template as a formulaic guide. Research techniques to answer the questions include literature review, interviews of involved stakeholders, examination of publicly available material like legislation,

review of locally used planning procedures, a review of geoinformation databases, and a review of standards or norms. Moreover, the teams relied on data and parts of the methodology developed by other teams working on Annex 73, like the classification of energy system architectures. The methodology is described in the Annex 73 Guidebook.

## REFERENCES

- Arponen, T. 2018. Jättimäisillä luolalämpövarastoilla joustavuutta ja lisää uusiutuvaa energiaa, (2018). <https://www.helen.fi/yrittys/vastuullisuus/ajankohtaista/blogi/2018/jattimaisilla-luolalampovarastoilla-joustavuutta-ja-lisaa-uusiutuvaa-energiaa/>.
- British Columbia. 2020. "British Columbia's Carbon Tax." *British Columbia*. Web page. <https://www2.gov.bc.ca/gov/content/environment/climate-change/planning-and-action/carbon-tax>
- C40 Cities. 2011. Eco-Efficient Heating and Cooling in Helsinki Saves 2.7 Mt CO<sub>2</sub> Every Year, (2011). [https://www.c40.org/case\\_studies/eco-efficient-heating-and-cooling-in-helsinki-saves-27-mt-co2-every-year](https://www.c40.org/case_studies/eco-efficient-heating-and-cooling-in-helsinki-saves-27-mt-co2-every-year).
- Case, Michael, Richard J. Liesen, Alexander Zhivov, Matthew Swanson, Benjamin Barnes, and James Stinson. 2014. A Computational Framework for Low-Energy Community Analysis and Optimization. NY-14-011. New York, NY: ASHRAE Winter Conference. p. 283.
- Galkin-Aalto, M. 2013. *Cooling Energy Is Stored under Esplanade Park*. <https://www.helen.fi/en/news/2013/cooling-energy-is-stored-under-esplanade-park/>.
- Galkin-Aalto, M. 2017. *Large Heat Pumps Arrive in Helsinki*. <https://www.helen.fi/en/news/2017/large-heat-pumps-arrive-in-helsinki/>.
- Galkin-Aalto, M. 2018. Construction Of Finland's Largest Rock Cavern Heat Storage Facility Starts. <https://www.helen.fi/en/news/2018/Construction-of-rock-cavern-heat-storage-facility-starts/>.
- Griffin, Jeff, Paul Holt, Jim Torcov, Joshua Wauthy, and David Woodson. 2018. "A Symposium on the UBC Transition: The Evolution of Low Carbon District Energy and Innovative Solutions at University of British Columbia." *IDEA2018: Local Solutions, Global Impact. International District Energy Association*. <https://www.districtenergy.org/viewdocument/a-symposium-on-the-ubc-transition>
- Helen Co. 2018a. *Finland's Largest Rock Cavern Heat Storage Planned For Helsinki*.
- Helen Co. 2018b. *New Heat Pump to Be Built Again in Helsinki*. <https://www.helen.fi/en/news/2018/newheatpump/>.
- Helen Co. 2018c. *Sinnemäki Inaugurates Helen's Underground Heating and Cooling Plant*. <https://www.helen.fi/en/news/2018/Sinnemäki-inaugurates-underground-heating-and-cooling-plant/>.
- Helen Co. 2018d. *Cooling Demand in Helsinki at a Record Level, Underground Reservoirs Are Used*. <https://www.helen.fi/en/news/2018/Cooling-demand-in-Helsinki-at-a-record-level/>.
- Helen Co. 2018e. *New Underground Heating and Cooling Plant Uses Waste Heat*. <https://www.helen.fi/en/news/2018/Underground-heating-and-cooling-plant-utilises-waste-heat/>.
- Helen Co. 2018f. *Combined District Heating and Cooling Quality of Living With Globally Exceptional and Eco-Efficient District Cooling in the World*.
- Helen Co. Undated. *Katri Vala heating and cooling plant*. Web page.(n.d.). <https://www.helen.fi/en/company/energy/energy-production/power-plants/katri-vala-heating-and-cooling-plant/>.
- Helsinki, City of. 2014. *Katri Vala Heating and Cooling Plant*. <http://www.stadinilmasto.fi/files/2014/08/Heating-and-cooling-plant.pdf>.

- Helsinki, City of. 2018. *Helsinki Announces Plan How to Become Carbon Neutral by 2035*. <https://www.hel.fi/uutiset/en/kaupunkiymparisto/carbon-neutral-helsinki>.
- IEA EBC Annex 73. 2021. Case Studies. TBC.
- International District Energy Association. 2015. "UBC On Track to Meet Sustainability Goals." *District Energy Magazine*. Quarter 4, 2015. <http://www.districtenergy-digital.org/districtenergy/2015Q4?pg=49#pg49>, P 49.
- International District Energy Association. 2018. "Metro Vancouver's Vibrant District Energy Market." *District Energy Magazine*. Quarter 2, 2018. <http://www.districtenergy-digital.org/districtenergy/2018Q2?pg=14#pg14>, pp 12-20.
- Jääskeläinen, S. 2018. The World's First Seasonal Energy Storage Facility of its kind is planned for the Kruunuvuorenranta rock caverns. <https://www.helen.fi/en/news/2018/Seasonal-energy-storage-facility-is-planned-for-the-Kruunuvuorenranta-rock-caverns/>.
- Kaartokaallio, E. 2018. *Maanalaisen lämpöpumppulaitoksen ensipyöräytykset*. <https://www.helen.fi/yrittys/vastuullisuus/ajankohtaista/blogi/2018/maanalaisen-lampopumppulaitoksen-ensipyoraytykset/>.
- Kestävä Energia Talous, Helenin lämpöpumppulaitos osaksi Suomen sähköverkon säätövoimaa, (2017). <https://www.energiatalous.fi/?p=1112>.
- Kotilainen, S., A mega plant in disguise, (2015) 1–4.
- Liesen R., M. Swanson, M. Case, A. Zhivov, A. Latino and D. Dreyer. 2015. Energy Master Planning Toward Net Zero Energy Installation— Portsmouth Naval Shipyard. CH-15-015. ASHRAE Transactions, Volume 121, Part 1.
- Peters, A.. 2014. *In Downtown Helsinki, A Giant Underground Reservoir Is Keeping The City Free From Air Conditioners*. <https://www.fastcompany.com/3036427/in-downtown-helsinki-a-giant-underground-reservoir-is-keeping-the-city-free-from-air-conditi>.
- Tsvetomira, T. 2018. Finland's Helen inaugurates renewable district heating plant. <https://renewablesnow.com/news/finlands-helen-inaugurates-renewable-district-heating-plant-602319/>.
- UBC (The University of British Columbia). Undated[a]. *Climate Action Plan*. Web page. <https://sustain.ubc.ca/campus-initiatives/climate-energy/climate-action-plan>
- UBC (The University of British Columbia). Undated[b]. *Bioenergy Research Demonstration Facility (BRDF)*. Web page. <http://energy.ubc.ca/projects/brdf/>
- Urban A., E. Keysar, K. Judd, A. Srivastava, C. Thompson, M. Case, A. Zhivov. 2020. Energy Master Planning for Resilient Public Communities— Best Practices from U.S. Military Installations. OR-20-022. ASHRAE Transactions, Volume 126, Part 1.
- Uusitalo, S. 2015. *Largest Electricity Storage Facility in the Nordic Countries to Be Built in Helsinki*. <https://www.helen.fi/en/news/2015/largest-electricity-storage-facility-in-the-nordic-countries-to-be-built-in-helsinki/>.
- Uusitalo, S.. 2018. *Helen Ready To Phase Out Coal*. <https://www.helen.fi/en/news/2018/ready-to-phase-out-coal/>.
- Zhivov A., M. Case, R. Liesen and M. Swanson. 2015a. Demonstrate Energy Component of the Installation Master Plan Using Net Zero Installation Virtual Testbed. ESTCP Project EW-201240. September 2015.

Zhivov A., M. Case, R. Liesen, M. Swanson, B. Barnes, A. Woody, S. Richter, A. Latino, C. Björk, L. Fiedler, P. Simihtis. 2015b. Energy Master Planning Toward Net Zero Energy Installation— U.S. Military Academy, West Point. CH-15-014. ASHRAE Transactions, Volume 121, Part 1.

Zhivov, Alexander M., Michael Case, Richard Liesen, Jacques Kimman, and Wendy Broers. 2014. Energy Master Planning Towards Net Zero Energy Communities/Campuses. NY-14-010. New York, NY: ASHRAE Winter Conference. p. 325.

## ACRONYMS AND ABBREVIATIONS

<b>Abbreviation</b>	<b>Term</b>
AAFB	Andersen Air Force Base
ACUPCC	American College and University Presidents' Climate Commitment
ADES	Academic District Energy System
AEWRS	Army Energy and Water Reporting System
ARC	Name of a Danish waste incinerator plant
ATES	Aquifer Thermal Energy Storage
ATP	Army Doctrine and Training Publication (ATP)
AUT	(Austrian) University Campus Technik in Innsbruck
BAU	Business as Usual
BC	British Columbia
BMP	Best management practices
BN	Bottleneck
BOG	Board of Governors
BRDF	Bioenergy Research and Demonstration Facility
CAMX	California region
CAP	Climate Action Plan
CARB	California Air Resources Board
CBA	Cost-Benefit Analyses
CBECS	Commercial Buildings Energy Consumption Survey
CCHP	Combined Cooling, Heat and Power
CCU	Carbon Capture and Use
CDC	Child Development Center
CEC	Campus Energy Centre
CEIP	Comprehensive Energy Investment Plan
CEQA	California Environmental Quality Act
CHCP	Combined Heating and Cooling Plant
CHW	Chilled Water
CLT	Cross-laminated timber
CNIC	Commander, Navy Installations Command
CNPRC	California National Primate Research Center
COP	Coefficient of Performance
CPFM	Campus Planning and Facilities Management
CTR	Name of a Danish Heat Transmission Company
CVHG	Product Name of a Chiller
DES	Distributed Energy System
DH	District Heating
DH&C	District Heating and Cooling
DKK	Danish currency (Danish krone)



<b>Abbreviation</b>	<b>Term</b>
DoD	U.S. Department of Defense
DPW	Directorate of Public Works
DTU	Technical University of Denmark
E&W	Energy and water
EBC	Energy in Buildings and Communities Program
EEM	Energy efficiency measures
EER	Embrace an Ethic of Regeneration
EMAS	Eco Management and Audit Scheme
EMP	Electro-Magnetic Pulse
EPA	Environmental Protection Agency
EPE	El Paso Electric
ERA	Energy Resilience Analysis
ERCIP	Energy Resilience and Conservation Investment Program
ERCOT	Electric Reliability Council of Texas
ESCO	Energy Service Company
ESPC	Energy Service Performance Contracts
ESTCP	Environmental Security Technology Certification Program
EUI	Energy Use Intensity
FFG	Forschungsförderungsgesellschaft (Austrian Research Promotion Agency)
FORSCOM	U.S. Army Forces Command
FWSKP	Fighter Wing Skrydstrup
GHG	Greenhouse gas
GPA	Guam Power Authority
GSF	Gross Square Foot
HDPE	High Density Polyethylene
HHW	Heating hot water
HNG	Danish Gas Distribution Company
HOFOR	Copenhagen Distribution Company
HP	Heat pumps
HQDA	Headquarters, Department of the Army
HTM	Human Thermal Model
HVAC	Heating, Ventilating, and Air-Conditioning
IDEA	International District Energy Association
IEA	International Energy Agency
IEWP	Installation Energy and Water (IEWP)
INSEL	Graphical Programming Language for Simulation of Renewable Energy Systems
IoT	Internet of Things
IREES	Institut für Ressourceneffizienz und Energiestrategien
IRR	Internal Rate of Return
IT	Information Technology

<b>Abbreviation</b>	<b>Term</b>
JCU	James Cook University Townsville (Australia)
JRM	Joint Region Marianas
KPI	Key Performance Indicators
LC	Life Cycle
LCC	Life cycle cost
LCV	Lower calorific value
LED	Light Emitting Diode
LPG	Liquefied Petroleum Gas
ME	Means To Overcome
MFGI	Mobilization-Force Generation Installation
MILCON	Military construction
MOB	Medical office building
MOBO	Multi Objective Building Energy Optimization
NBG	Naval Base Guam
NESA	Danish Electricity Distribution Company
NORFOR	Danish Heat Transmission System
NPV	Net Present Value
NTNU	Norwegian University of Science and Technology
NZE	Net zero energy
O&M	Operations and Maintenance
OECD	Organization for Economic Cooperation and Development
OIB	Österreichisches Institut für Bautechnik (Austrian Institute for Structural Engineering)
PEER	Performance Excellence in Electricity Renewal
PEH	PolyEthylene High Density
PESTEL	Political, Economic, Social, Technological, Environmental and Legal
PG&E	Pacific Gas and Electric
PV	PhotoVoltaic
QR	Quick Response (code)
R&D	Research and development
RFI	Request for Information
RFP	Request for proposal
RFQ	Request for Qualifications
RGEC	Rio Grande Electric Cooperative
ROI	Return on investment
RPI	Real property inventory
RUMBA	Guidelines For Environmentally Sound Construction Logistics
SCADA	Supervisory Control and Data Acquisition
SME	Subject Matter Expert
SRC	Strategic Research Council
SRM	Sustainment, Restoration and Modernization

<b>Abbreviation</b>	<b>Term</b>
SWOT	Strengths, Weaknesses, Opportunities, and Threats
TALC	Methodology That Identifies Customer Profiles
TEC	Temporary Energy Centre
TERMIS	District Energy Network Simulation Platform
TES	Thermal Energy Storage
TESS	Thermal Energy Storage System
TEST	Thermal Energy Storage Tank
TGA	Thermogravimetric Analysis
TIRIS	GIS Information System of Tirol
TU	Technical University
UBC	University of British Columbia
UC	University of California
UEM	Utilities and Energy Management
UESC	Utility Energy Savings Contract
UFC	Unified Facilities Criteria
UP	[Army] Utilities Privatization
UPS	Uninterruptible Power Supply
VCRS	Conventional Cooling
VEKS	Metropolitan Transmission Company in Denmark
VFD	Variable Frequency Drive
VTT	Finnish National Technical Research Institute
WAPA	Western Area Power Administration
WECC	Western Electricity Coordinating Council
WHO	World Health Organization
WU	University of Economy Vienna
ZEN	Zero Emission Neighborhoods in Smart Cities Project