

Policies for Building Energy Conservation of residential and non-residential buildings in Japan

9 November 2021

Takashi IMAMURA
Counselor for Building Regulations
Housing Bureau, MLIT, JAPAN



Ministry of Land, Infrastructure, Transport and Tourism

GHG emission reduction goals of countries

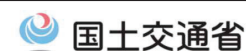

Country /Region	NDC (2030 goal)	Date of NDC submitted	Net zero by 2050
Japan	-46% (from 2013 level) Japan will continue efforts to meet the lofty goal of cutting its emission by 50%.	NDC submitted on 22 October 2021	Declared
U.S.	-50 to -52% (from 2005 level)	NDC submitted on 22 April 2021	Declared
Canada	-40 to -45% (from 2005 level)	NDC submitted on 12 July 2021	Declared
U.K.	-68% or more (from 1990 level)	NDC submitted on 12 December 2020	Declared
France, Germany, Italy, EU	-55% or more (from 1990 level)	NDC submitted on 18 December 2020	Declared
Australia	-26 to -28% (from 2005 level)	NDC submitted on 31 December 2020	-
Brazil	-43% (from 2005 level)	NDC submitted on 9 December 2020	Declared

Köppen-Geiger climate classification map (1980-2016)

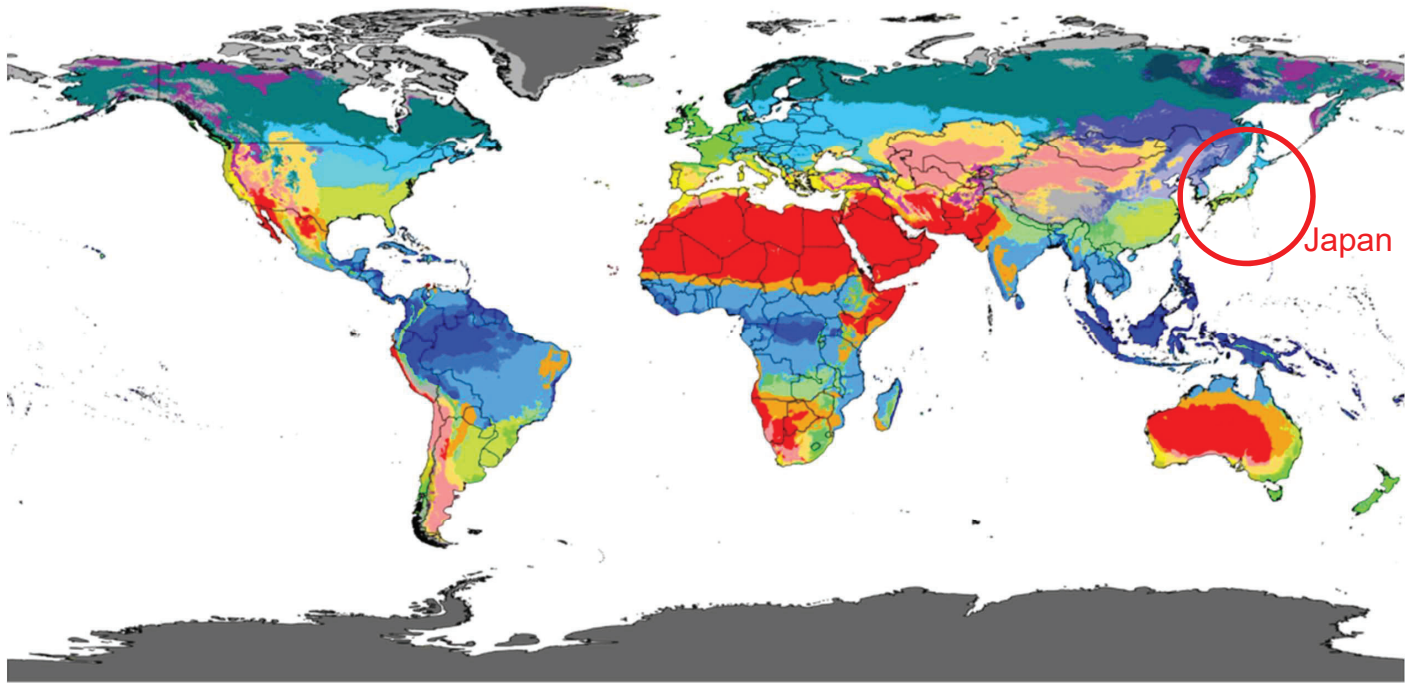

Source: Beck et al.: Present and future Köppen-Geiger climate classification maps at 1-km resolution, Scientific Data 5:180214, doi:10.1038/sdata.2018.214 (2018)

Source: Wikipedia

Location of Japan on top of the European map

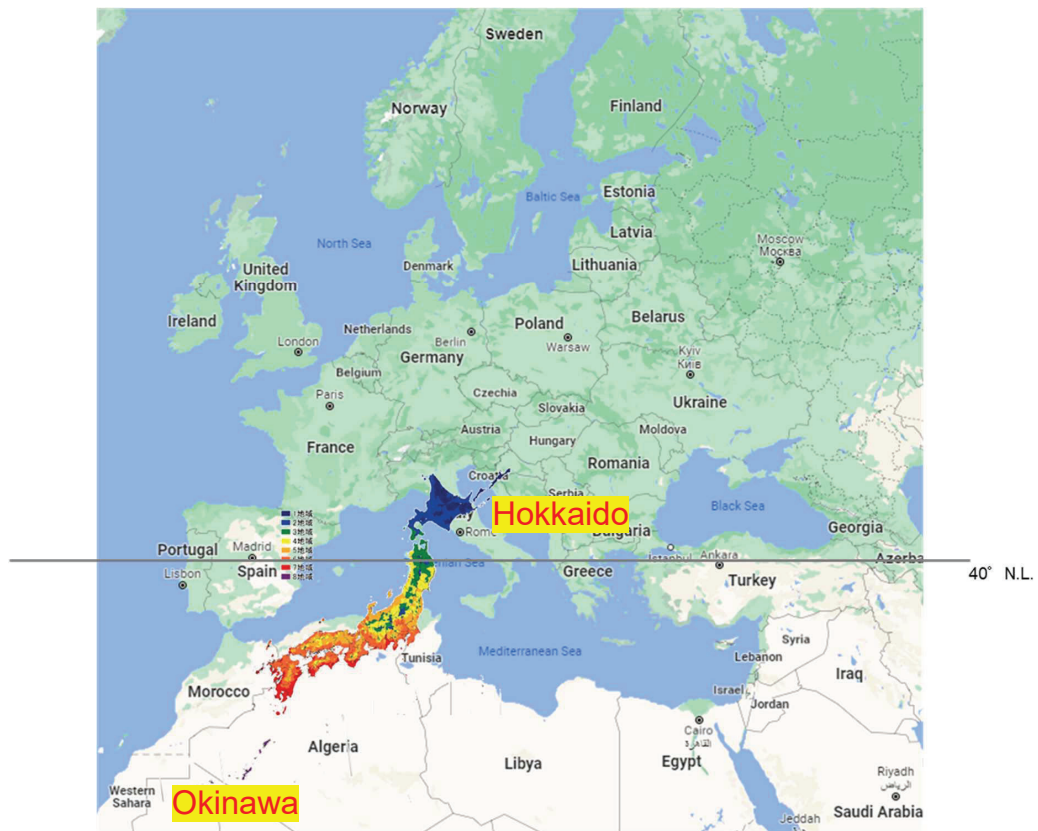

Map Data @2021 Google

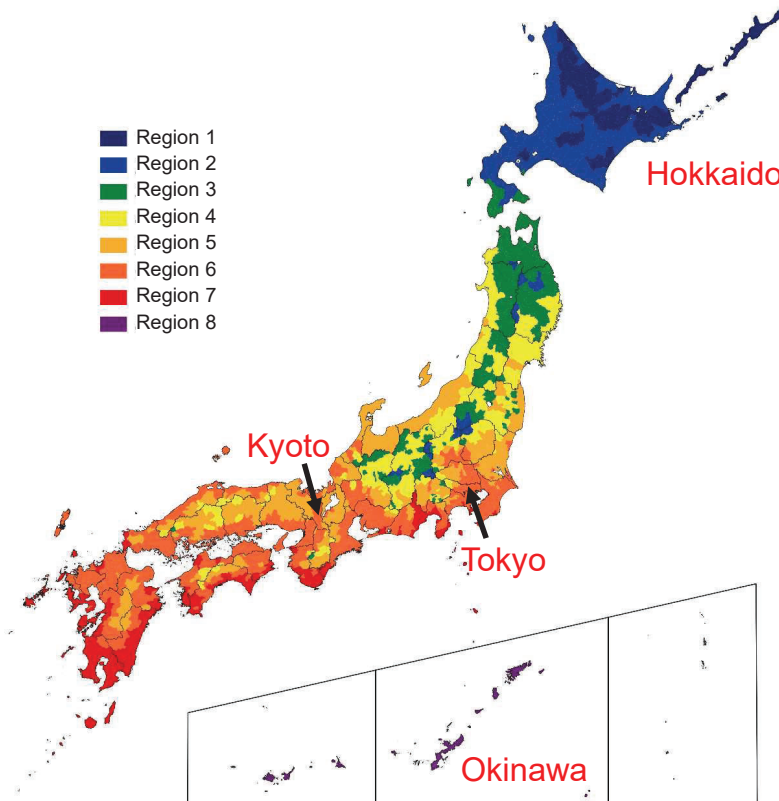

4

- Consumption per household in Japan is about one-third of that in the U.S. and about half that in Germany and other European countries.
- Japan's energy consumption for "heating" is particularly low, while consumption of "hot water supply" is higher. While people in other countries heat/cool their homes for a long time, most Japanese way of living is "intermittent heating/cooling". Japanese people heat/cool their homes only when they are at home.

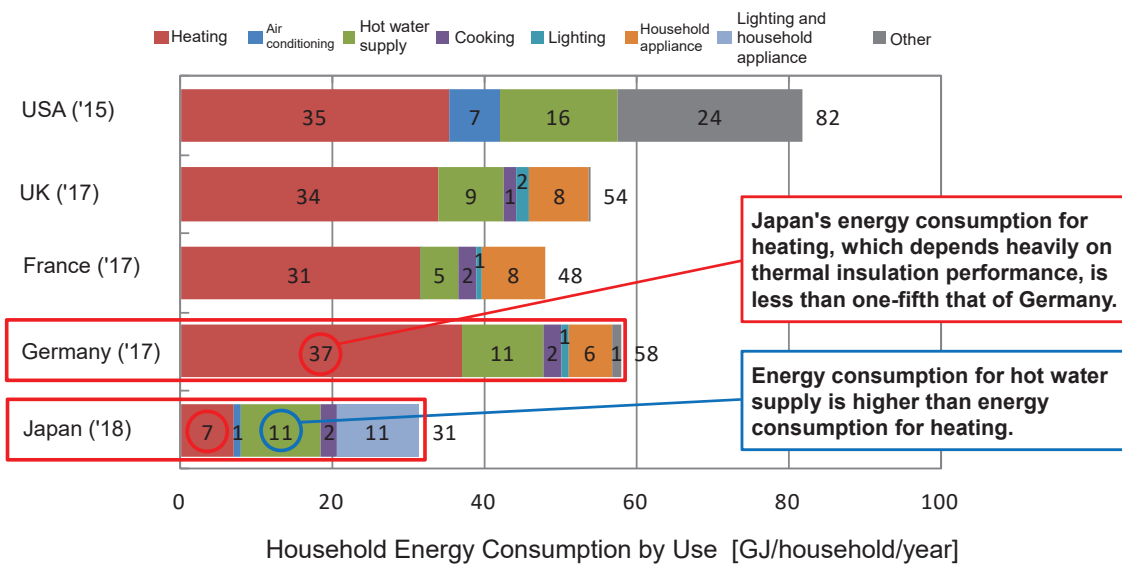

Japan's energy consumption for heating, which depends heavily on thermal insulation performance, is less than one-fifth that of Germany.

Energy consumption for hot water supply is higher than energy consumption for heating.

* USA.(Other) includes cooking, lighting, and household appliances.

Annual Household Energy Consumption by Region

[GJ/household/year]

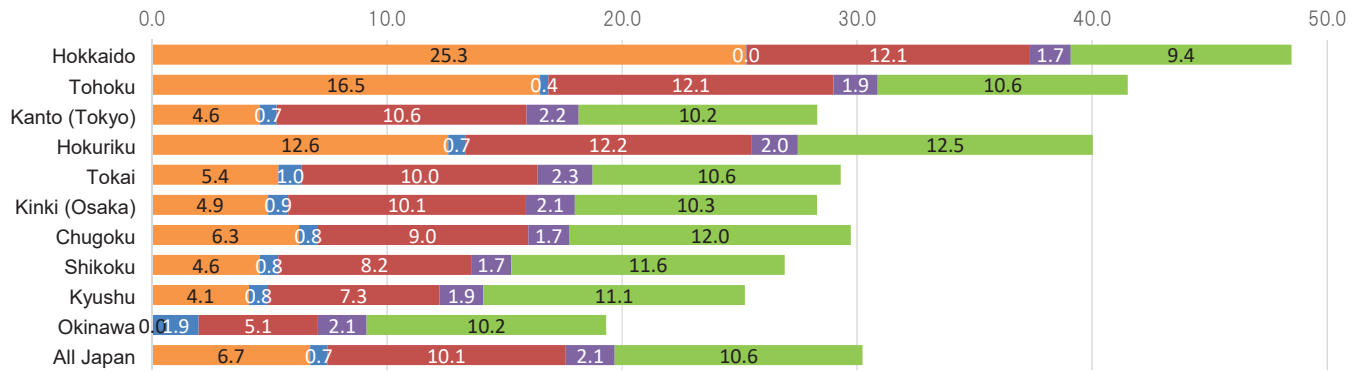

Annual Household Energy Consumption by Region (Ratio by Use)

[%]

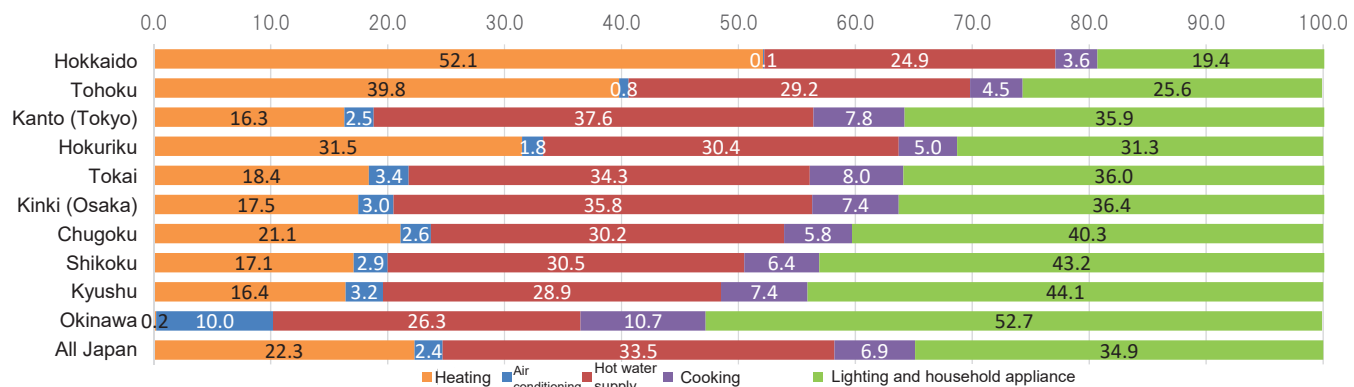

Source: Ministry of the Environment of Japan

Trends in Japan's Energy Consumption by Sector

- While other sectors (industry and transportation) have decreased, **energy consumption in the commercial and household sectors have increased significantly (16.9% from the 1990 level (left Figure)).** They accounts for **about 30% of total energy consumption (right Figure).**
- **Drastic reinforcement of energy-saving measures on houses and buildings is essential.**

Trends in final energy consumption

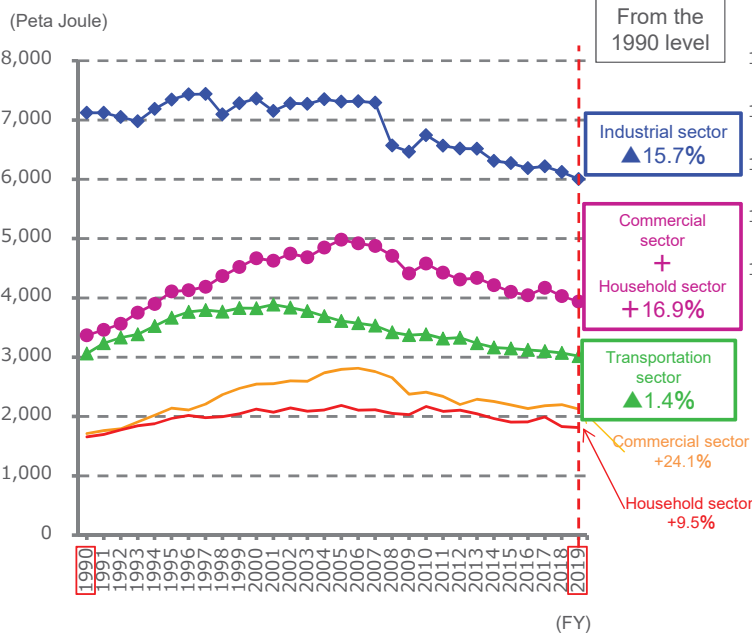

Trend of shares

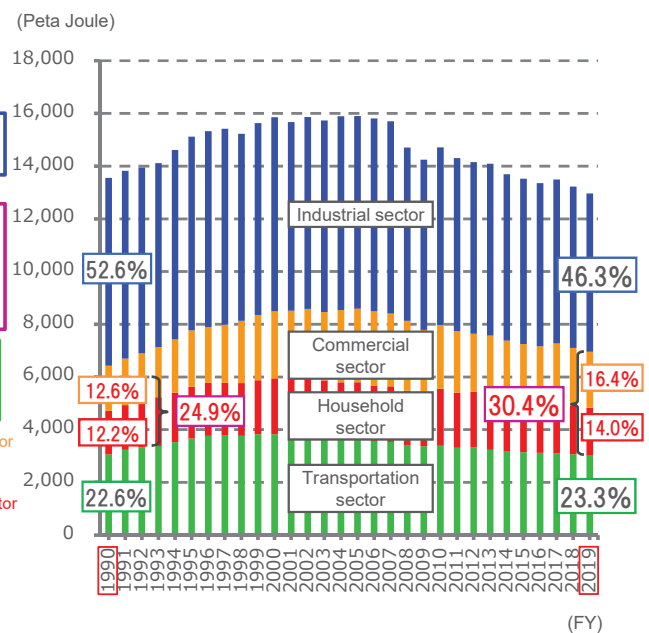

Source: Comprehensive Energy Statistics (ANRE)

Reduction targets in the field of houses and buildings

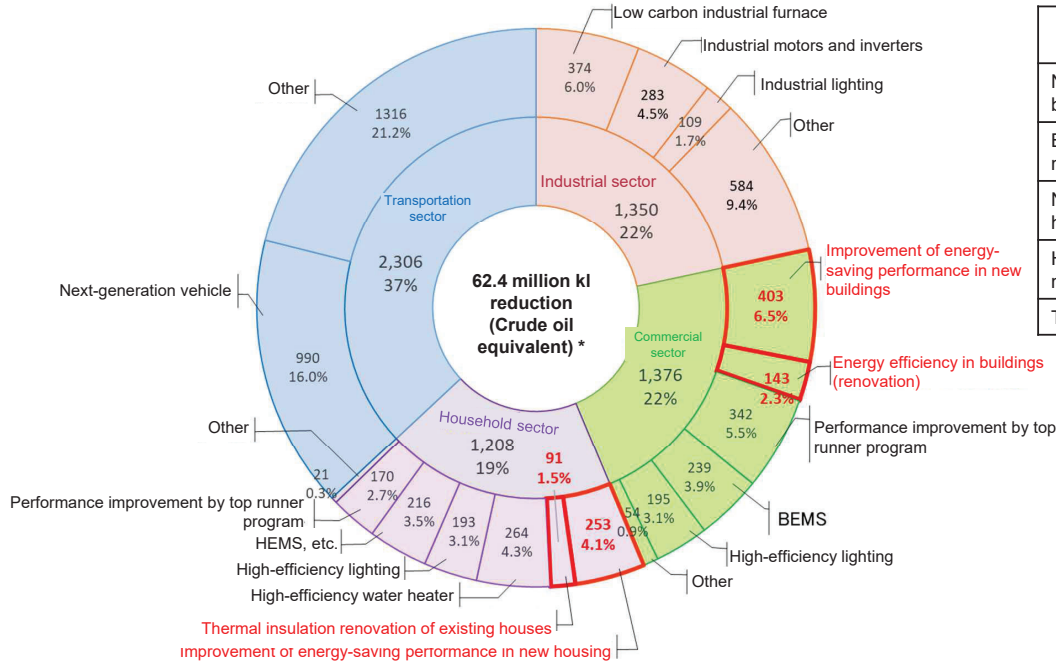

	Amount of reduction
Newly constructed building	403
Building renovation	143
Newly constructed housing	253
Housing renovation	91
Total	889

* Total does not match due to rounding.

* Reduction target of the previous Plan for Global Warming Countermeasures (May 2016): about 50.3 million kl

Source: Energy Demand and Supply Outlook for FY2030 (Sep. 2021) (Agency for Natural Resources and Energy)

Regulatory Measures under the Building Energy Efficiency Act of Japan

	Upon establishment of the Act (promulgated on July 2015)		After revision (promulgated on May 2019)	
	Non-residential	Residential	Non-residential	Residential
Large (2,000 m ² or more)	Specific building Obligation of compliance [Linked to the building certification procedure]	Obligation of notification [Instruction, order, etc. to be issued when the standard is not met and issuance is deemed necessary]	Specific building Obligation of compliance [Linked to the building certification procedure]	Obligation of notification [Instruction, order, etc. to be issued when the standard is not met and issuance is deemed necessary]
Medium (300 m ² or more but less than 2,000 m ²)	Obligation of notification [Instruction, order, etc. to be issued when the standard is not met and issuance is deemed necessary]	Obligation of notification [Instruction, order, etc. to be issued when the standard is not met and issuance is deemed necessary]	Obligation of compliance [Linked to the building certification procedure]	<u>Streamlining the examination procedures in the competent administrative agency</u> ⇒ Focus on implementation of supervision (instruction, order, etc.)
Small (less than 300 m ²)	Effort obligation [Improvement of energy-saving performance]	Effort obligation [Improvement of energy-saving performance]	Effort obligation [Compliance with the energy efficiency standards] + Obligation of the architect to explain to the building owner	Effort obligation [Compliance with the energy efficiency standards] + Obligation of the architect to explain to the building owner
		Top runner program* [Compliance with the top runner standards] Target housing Owner-occupied house, Detached house for sale		Top runner program* [Compliance with the top runner standards] <u>Expansion of the target</u> Target housing Owner-occupied house, Detached house for sale, Custom-built detached house, House for rent, Apartment for rent

* If it is deemed necessary to improve the energy-saving performance of a major housing developer to a considerable extent, such as insufficient compliance with the top runner standards, the developer will be subject to the recommendation, order, etc. by the Minister of MLIT.

➤ The number of buildings subject to the obligation of compliance accounts for 3.4% of the total number of building starts (0.6% for large buildings and 2.8% for medium buildings), but their energy consumption accounts for 52.2% of the total energy consumption (36.3% for large buildings and 15.9% for medium buildings).

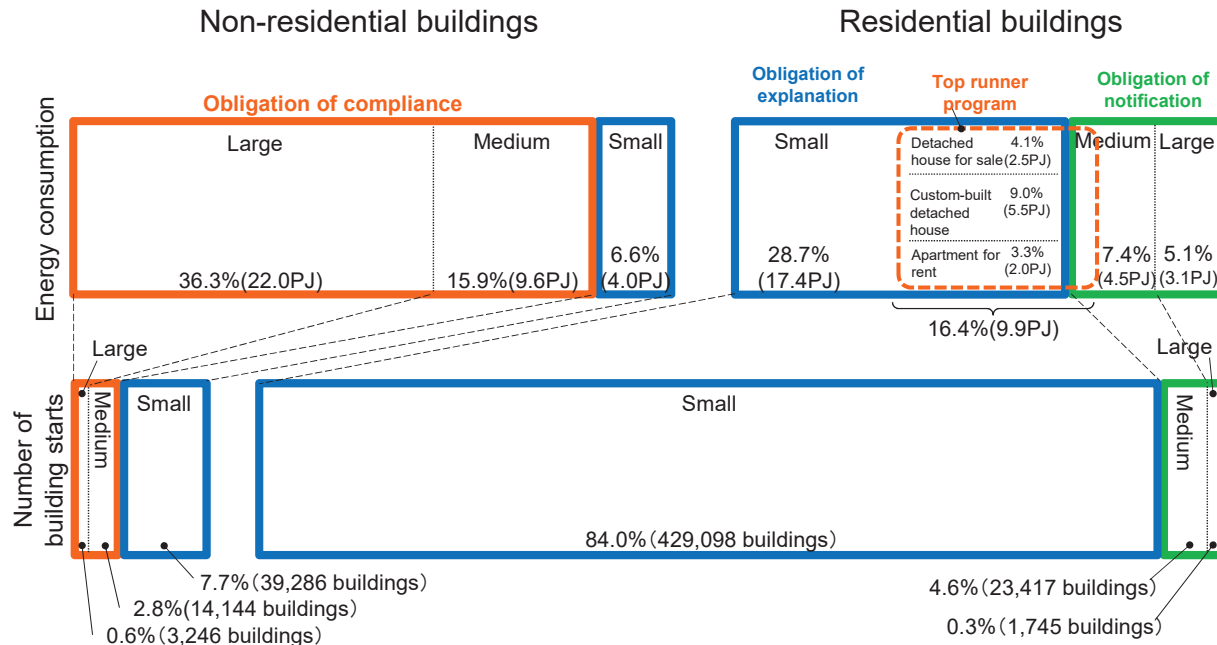

* Estimated by assuming that the average energy intensity of buildings is 878 MJ/m²/year, and average energy intensity of houses is 344MJ/m²/year, based on the 2017 Energy and Economy Statistical Abstract and the 2017 Statistics on Building Starts.

➤ The rate of compliance with energy efficiency standards for newly constructed housing has been rising year by year, and the rate of compliance in total housing exceeded 80% in FY2019.

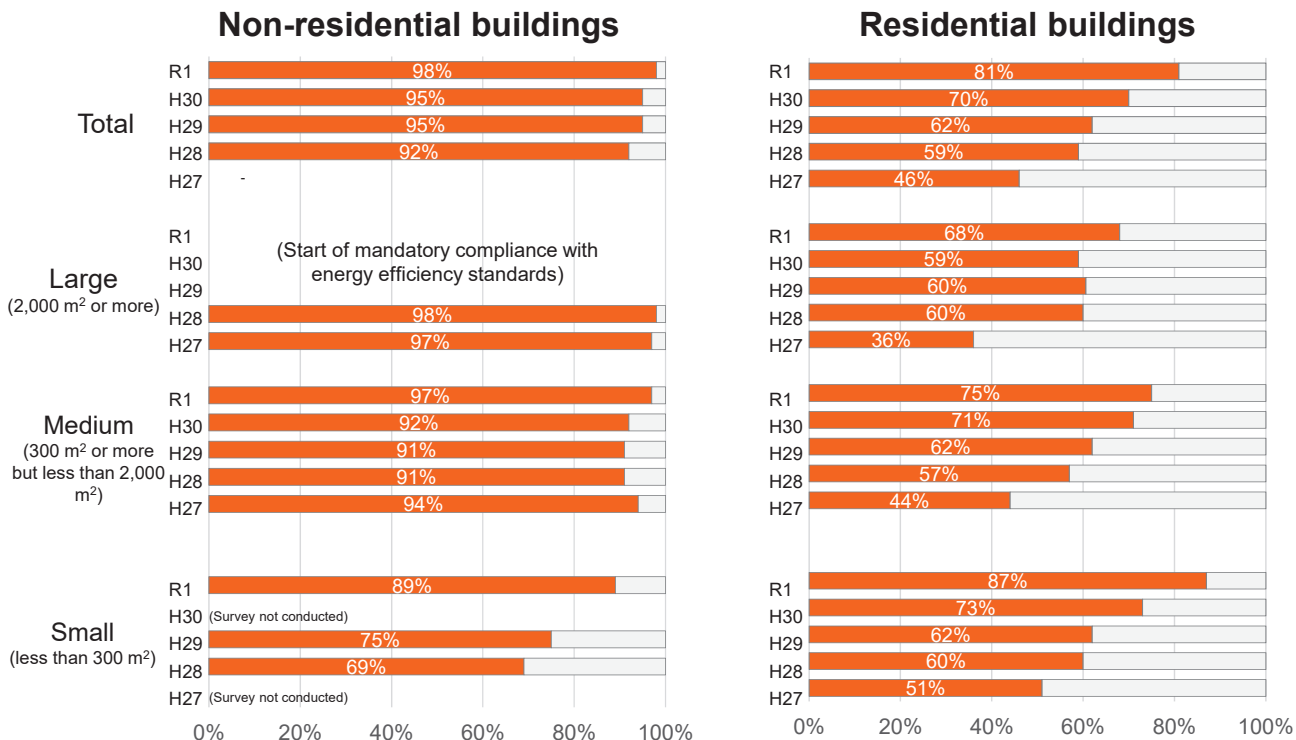

* Calculated in the same manner as the FY2015 standard compliance rate in the Summary of the workshop on the actual state of energy consumption performance in housing and buildings (March 30, 2018).

➢ The Japanese energy efficiency standards for buildings are the standards that are necessary to ensure the energy-saving performance required for buildings as well as building equipment. They consist of two standards: “primary energy consumption” standards and “envelope insulation” standards.

Primary energy consumption standards (Apply to both residential and non-residential buildings)

Primary energy consumption shall be equal to or less than the standard value.

- * "Primary energy consumption"
 - = Air conditioning energy consumption + Ventilation energy consumption
 - + Lighting energy consumption + Hot water supply energy consumption
 - + Elevator energy consumption
 - + Other energy consumption (OA equipment, etc.)
 - Energy creation by solar power generation equipment, etc. (limited to self-consumption)

Envelope insulation standards (apply only to residential buildings)

Heat loss per surface area of the “envelope” (outer wall, window, etc.), or envelope average heat transmission coefficient, etc. shall be equal to or less than the standard value.

<Image of heat loss through “envelope”>

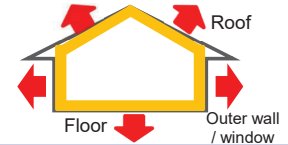

- * Envelope average heat transmission coefficient
- = Total heat loss / Envelope surface area

Examples of initiatives to improve energy-saving performance

[Non-residential buildings]



[Residential buildings]

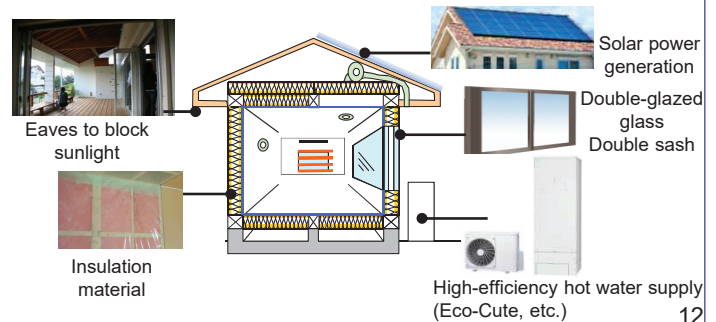

International Comparison of the Envelope Average Heat Transmission Coefficient Standards (UA Value) for Residential Buildings

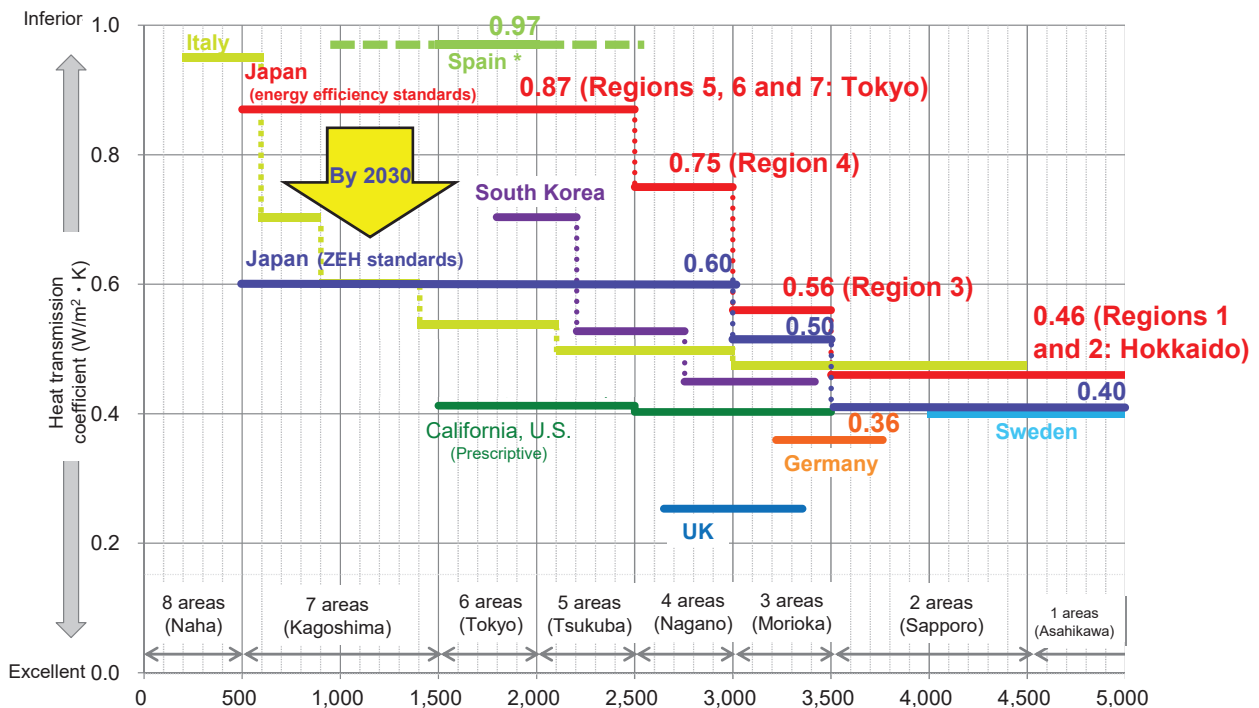

Source: FY2014 Commissioned research by the MLIT

*Commissioned research on energy efficiency regulations, standards, etc. in overseas housing and buildings.

* Compiled by Nomura Research Institute based on the energy efficiency standards for homes in various countries.

* The MLIT made addition to the standards for Spain and Sweden.

* Created in consideration of heating degree days (degree day) in Madrid.

Heating Degree Day (Degree day)

Definition of ZEH (Net Zero Energy House)

➤ **"ZEH" is defined as "a house in which energy consumed per year is approximately zero or less on a net basis by striving to save as much energy as possible through high envelope insulation and high efficiency equipment in the house while maintaining a comfortable indoor environment, and by creating energy through solar power generation and other means."**

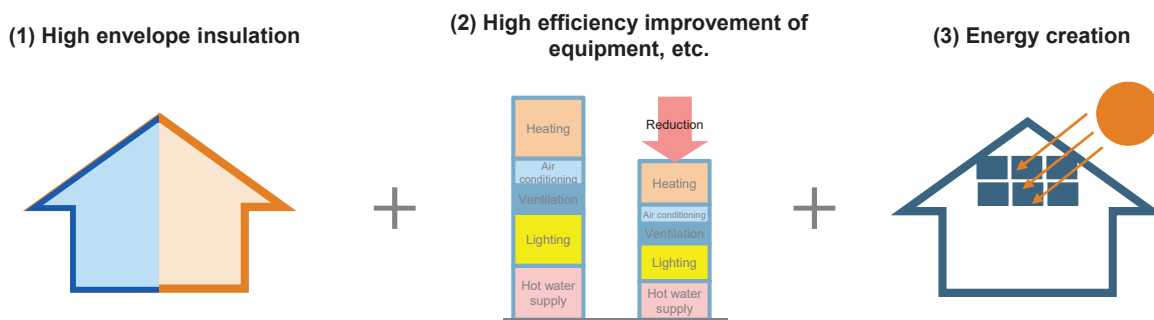

Envelope insulation standards	Primary energy consumption standards																
	High efficiency improvement of equipment, etc.	(Energy creation)															
<p>High envelope insulation standards that are stricter than the energy efficiency standards</p> <p>(Standards for the envelope average heat transmission coefficient)</p> <table border="1"> <thead> <tr> <th>Regional classification</th> <th>Regions 1 and 2 (Sapporo, etc.)</th> <th>Region 3 (Morioka, etc.)</th> <th>Regions 4 (Nagano, etc.)</th> <th>Regions 5, 6 and 7 (Tokyo, etc.)</th> </tr> </thead> <tbody> <tr> <td>ZEH standards</td> <td>0.4</td> <td>0.5</td> <td>0.6</td> <td>0.6</td> </tr> <tr> <td>Energy efficiency standards</td> <td>0.46</td> <td>0.56</td> <td>0.75</td> <td>0.87</td> </tr> </tbody> </table>	Regional classification	Regions 1 and 2 (Sapporo, etc.)	Region 3 (Morioka, etc.)	Regions 4 (Nagano, etc.)	Regions 5, 6 and 7 (Tokyo, etc.)	ZEH standards	0.4	0.5	0.6	0.6	Energy efficiency standards	0.46	0.56	0.75	0.87	<p>20% reduction from the energy efficiency standards</p> <p>Without considering the energy creation by solar power generation, etc.</p>	<p>Reduce primary energy consumption to net zero or less</p> <p>Taking into account the energy created by solar power generation, etc., including the surplus electricity sold,</p>
Regional classification	Regions 1 and 2 (Sapporo, etc.)	Region 3 (Morioka, etc.)	Regions 4 (Nagano, etc.)	Regions 5, 6 and 7 (Tokyo, etc.)													
ZEH standards	0.4	0.5	0.6	0.6													
Energy efficiency standards	0.46	0.56	0.75	0.87													

Source: "ZEH Roadmap" compiled by the ZEH Roadmap Review Committee of the Ministry of Economy, Trade and Industry (METI) on December 17, 2015.

Energy-Saving Performance Indication System

➤ In order to indicate excellent energy-saving performance in houses and buildings, the Building-housing Energy-efficiency Labeling System (BELS) is operated as a system that conforms to the guidelines based on Article 7 of the Act.

➤ Indicated in five levels according to energy-saving performance through evaluation by a third party.

BELS (Building-housing Energy-efficiency Labeling System)

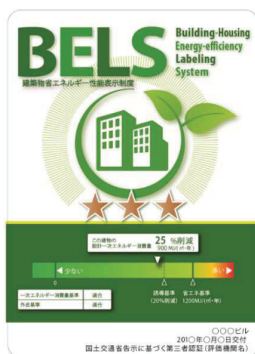

Records of BELS

(as of the end of July 2021)

Building type	Number of type
Detached housing	130,577
Residential complex	31,440
Non-residential building	2,195
Total	164,212

Item	Overview
System management entity	Housing Performance Evaluation and Labeling Council (a General Incorporated Association (GIA))
Target buildings	Newly constructed and existing houses and buildings
Evaluation target	Energy-saving performance at time of design for entire building *Depending on the evaluation method, floor unit, etc. is also possible.
Evaluator	Third-party evaluation by evaluation organization Evaluator: First-Class Registered Architects, Building Service Engineers, etc. who have taken and completed training held by a third-party
Evaluation indices (Primary energy)	• Primary energy consumption and BEI (Building Energy Index) = Design primary energy / Standard primary energy

- As of FY2019, about 13% of the total housing stock (about 50 million units) complied with the energy efficiency standards, and about 29% of the total housing stock was uninsulated.
- According to the Housing and Land Survey (2018), the actual number of thermal insulation renovations for the housing stock in less than five years from January 2014 to October 2018 was about 720,000 units.

Thermal insulation performance of housing stock (about 50 million units)

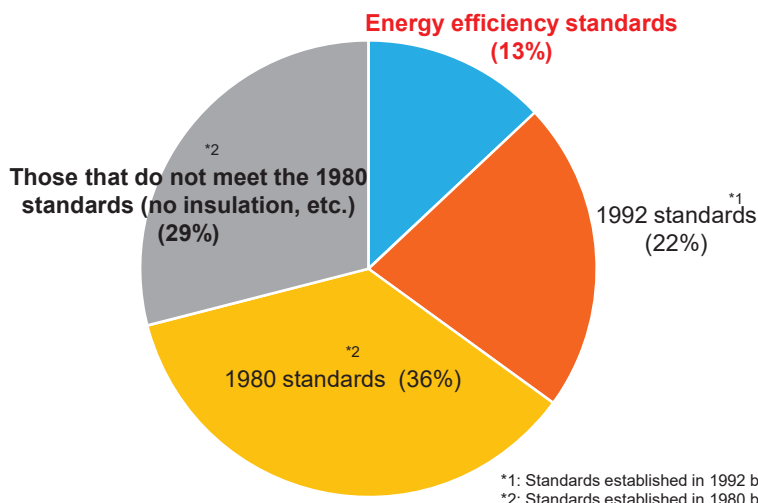

Source: Calculated based on the distribution of housing stock by performance according to the MLIT survey, reflecting the number of renovations according to the Housing and Land Survey and the estimated number of newly constructed housing units by performance based on business operator's questionnaire, etc. (FY2019).

Future Policies for Building Energy Conservation in Japan

- For energy-saving measures on housing and buildings, **the Building Energy Efficiency Act was established in 2015 to achieve the reduction target based on the Paris Agreement. The Act was revised in 2019 and the measures to achieve the target had been sequentially strengthened.**
- **Since April this year, we have been considering the direction of strengthening energy-saving measures in the housing and building sectors. We have provided a roadmap for strengthening measures based on this consideration. The new "Plan for Global Warming Countermeasures" also includes the following:**

- **Strengthen the Building Energy Efficiency Act**
 - ✓ **Mandatory compliance with the energy efficiency standards for all the newly constructed buildings, including residential buildings, by FY2025.**
 - ✓ **Gradual upgrade of the energy efficiency standards to the level of ZEH/ZEB standards by FY2030 at the latest.**
 - ✓ **Strengthen the indication of the energy-saving performance of residential and non-residential buildings when they are sold or leased.**
 - ✓ **Other measures, including those for existing buildings?**
- **Promote introduction of renewable energy (by financial incentives, etc.)**
 - ✓ **Install solar power generation equipment for 60% of newly constructed detached houses by FY2030.** (The target is set by the new "Plan for Global Warming Countermeasures")



ありがとうございました！
Thank you very much!
Merci beaucoup!
Muchas gracias!
Muito obrigado!

.....

Nagato City Hall

EBC



Energy in Buildings and
Communities Programme

EBC Building Energy Codes Working Group

David Nemetzow (U.S. Department of Energy and
BECWG Chair) and BECWG Team

IEA EBC Technology Collaboration
Programme Webinar in “Virtual Japan”

9 November 2021

1

Contents



1. BECWG overview and opportunities to collaborate
2. Webinars and reports
3. Release of report on practices for codes compliance
4. Highlights from BECWG Annual Symposium
 - National roadmaps that incorporate building energy codes
 - Codes to reduce carbon emissions

BECWG @ EBC Webinar 2

2

BECWG overview and opportunities to collaborate



Energy in Buildings and
Communities Programme

- ✓ **Chairs:** David Nemetzow, U.S. Department of Energy, and Michael Donn, Victoria University of Wellington, N.Z.
- ✓ **Operating Agent:** Meredydd Evans, U.S. Pacific Northwest National Laboratory. Team: Alison Delgado, PNNL; Jack Mayernik, NREL; Jeremy Williams, US DOE
- ✓ 15 member countries – AU, BR, CA, CN, IN, IE, IT, JP, NZ, PT, SG, SE, TR, GB, US – as well as ASHRAE and International Code Council.

We welcome new members! Feel free to participate in our webinars and get latest news. We would also love to **learn about codes in your country.** To join our mailing list e-mail: Alison.Delgado@pnnl.gov

Activity 1: Exchange on building energy code practices

- Webinars (~4/year), meetings, annual building energy code symposium

Activity 2: Comparative Analysis

- Reports on topics of shared interest (2 papers/year):
 - Codes to reduce carbon (embodied carbon)
 - New technology integration in codes (e.g., DER technologies)
 - Codes and climate resilience (e.g., extreme weather events and how buildings cope with these events)
 - Codes and regulations for data centers

Activity 3: Dissemination

- Newsletters, publishing results and lessons, outreach and dialog (Annex 80 resilient cooling, new EE Hub) feedback on IPCC WGIII Buildings Chapter, posting key information on the website

BECWG @ EBC Webinar 3

3

BECWG Webinars and Reports



- 2 Reports this year:
 - Building Energy Codes in Existing Buildings
 - Codes Compliance Best Practices
- Recent Webinars (To date, 9 total):
 - “Balancing Costs and Benefits of Building Energy Codes: An Evaluation of Methodologies for Assessing Cost-Effectiveness” (April 2021)
 - “Building Energy Codes and Other Mandatory Policies Applied to Existing Buildings” (June 2021)
 - “Codes Around the Globe: A Cross-national Comparison of Building Energy Codes,” 2021 National Energy Codes Conference Summer Seminar Series

Past Webinar and Technical Presentations:

1. “Defining Future Direction” (May 2019)
2. “Cross National Comparison” (July 2019)
3. “Building Codes Implementation Practices” (September 2019)
4. “Building Energy Issues and the COVID-19 Response” (May 2020)
5. “Towards Net or Nearly Zero Energy Buildings” (May 2020)
6. “Energy Codes for Existing Buildings” (June 2020)
7. “Changing Business-as-usual: Building Code Virtual Diagnostics & Inspections” (September 2020)

* First Annual Symposium (Sept. 2020):

- 1) Integrating Research and Technology Breakthroughs in Codes, and 2) Adapting/Expanding Code Coverage in Places with Hot Climates

4

4

Report on Practices for Codes Compliance (Released 3 Nov.)



Energy in Buildings and
Communities Programme

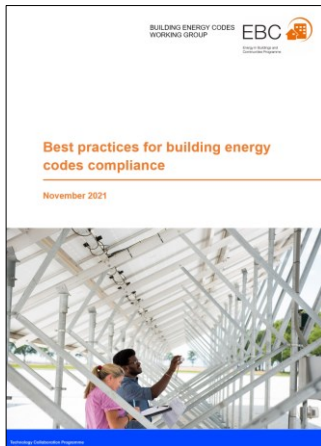

Report link: <http://www.globalchange.umd.edu/technology-and-policy/building-energy-codes/iea-ebc-working-group/>

- Based on a survey of 38 respondents across 11 countries
- Commonly faced issues related to enforcing code compliance centered around capacity building and training
- Report drew examples of notable practices from different jurisdictions. Major themes include:
 1. Pooling resources to minimize redundant efforts and maximize resources
 2. Requiring accreditations and trainings of inspectors and official government endorsement of third parties
 3. Utilizing a data driven approach to improve code implementation
 4. Utilizing remote inspections to check compliance when beneficial

BECWG @ EBC Webinar 5

5

BECWG Annual Symposium, 3 Nov.



Energy in Buildings and
Communities Programme

- Some business (new work plan, lots of activity this year)
- 2 technical panels:
 - Codes to Achieve Carbon Reductions
 - Presentations from China, Japan, and the United States
 - National Roadmaps that Incorporate Building Energy Codes
 - Presentations from Brazil, Canada, and a global roadmap for buildings and construction
- Some highlights of the Symposium follow in next 4 slides

BECWG @ EBC Webinar 6

6

Global assessment: Key actions for new buildings



Energy in Buildings and
Communities Programme

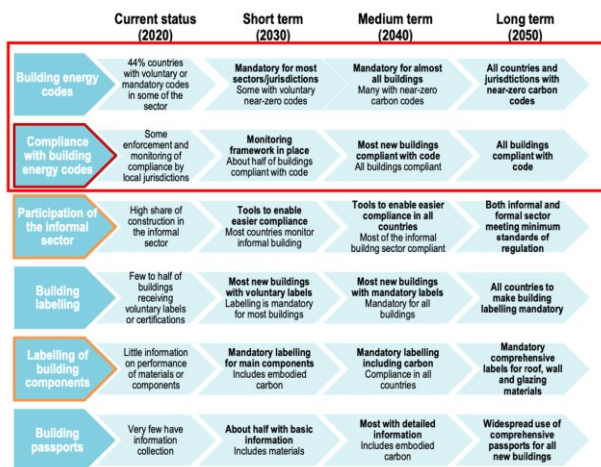
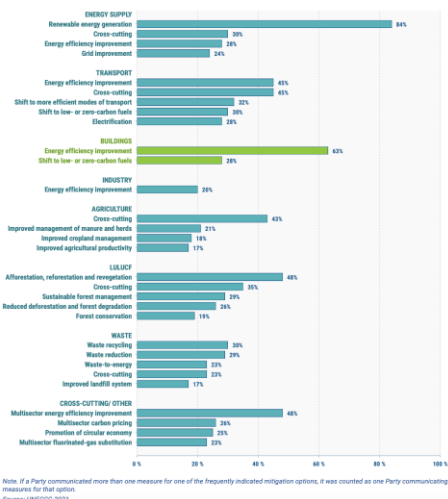

Speaker/source:
Prof. Ian Hamilton, Univ. College London Energy Institute

Building codes as critical action for new buildings
Source: IEA

Canada



Energy in Buildings and
Communities Programme

- Growing emphasis on harmonization
 - “Adapt and Adopt” framework has created a patchwork of energy efficiency requirements
- Four major national research topics:
 - Carbon reductions
 - EU vs. % better approaches
 - Embodied carbon
 - Existing buildings

BACKCASTING APPROACH

Define a target, and work backwards with fixed interim deadlines and requirements.

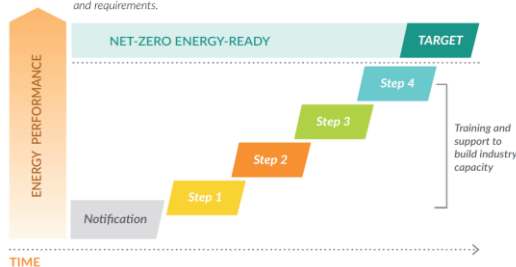

Speaker/source:
Alex Ferguson, Natural Resources Canada

BECWG @ EBC Webinar 8

China: Analysis of mid- to long-term energy savings and carbon reduction potential

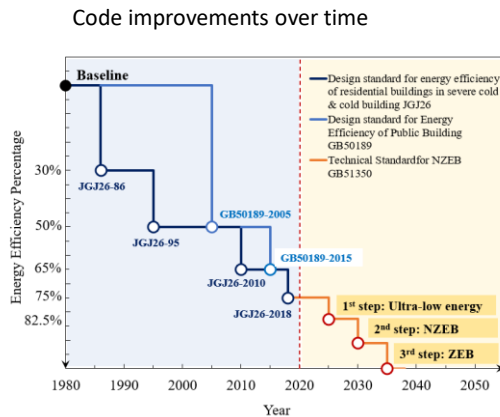

Projected carbon emission reductions

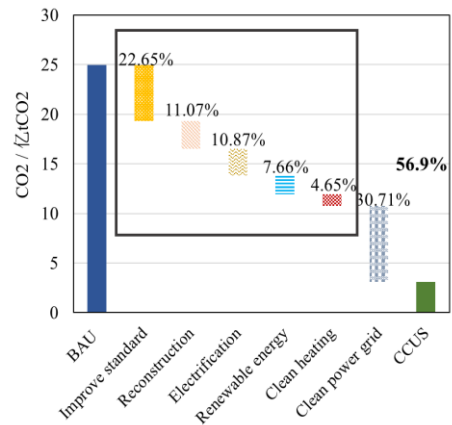

Speaker/source: Prof. Shicong Zhang, China Academy of Building Research

Zhang et al, Building Science, 2020. DOI:10.13614/j.cnki.11-1962/tu.2021.08.25

9

9

Japan: End-use energy targets in 2030 and distribution of Building Energy Index for total energy use

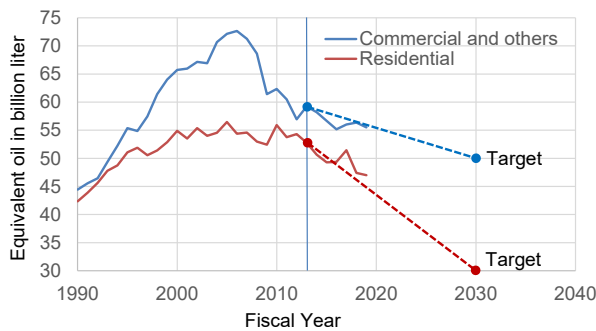

Transition of end-use energy and targets in FY2030

Speaker/source: Dr. Takao Sawachi, Building Technology Research Institute

件数=7699, 平均値=0.76, 中央値=0.77

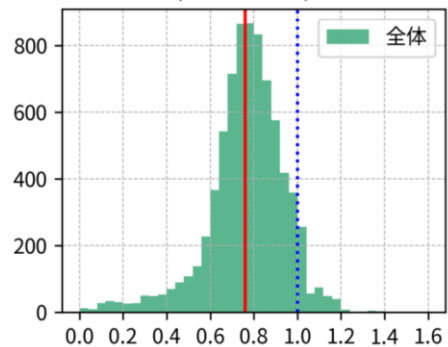

Sources: [FY2019 Energy Supply and Demand Report \(Revised Report\) \(meti.go.jp\)](https://www.meti.go.jp/eng/energy/energy_supply_demand/fy2019/); [国土技術政策総合研究所 研究資料 \(nilim.go.jp\)](https://www.nilim.go.jp/)

10

10

Thank you!



Link to Symposium presentations:

www.globalchange.umd.edu/technology-and-policy/building-energy-codes/ebc-symposium-2021/

Building Energy Codes Working Group:

www.iea-ebc.org/working-group/building-energy-codes

For more information:

Alison.Delgado@pnnl.gov

Mark your calendars:

*IEA's new Energy Efficiency Hub will have a launch event
1 Dec.*

*www.energyefficiencyhub.org/launch-event
All are welcome!*

11



Additional Slides

BECWG @ EBC Webinar 12

12

United States: Growing emphasis on deep decarbonization and net-zero codes



Energy in Buildings and

- No single approach to codes nationally
- Multiple states and cities have deep decarbonization goals
- Building Performance Standards in 6 Northeast states (e.g., 50% by 2030)
- Stretch codes in 10 states
- Net-zero codes or carbon neutrality zoning growing



Energy efficiency – prescriptive or performance path with prescriptive backstop

Electrification – no combustion (with exceptions), EV and demand response requirements

Renewable energy – achieve net zero, renewables demonstrating additionality, no weighting factors, on-site solar requirements

Zero Energy Codes

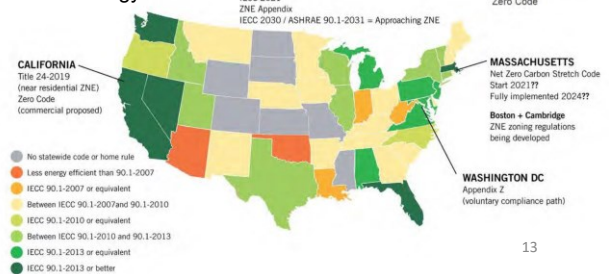

Source/speaker: Mr. Darren Port, Northeast Energy Efficiency Partnerships

13

13

Brazil: Transition from voluntary to mandatory performance standards



Energy in Buildings and
Communities Programme

- Carrying out a regulatory impact analysis to make Brazil's energy performance labeling mandatory
- Building performance standards expected to also have a major role as they are adopted by the building industry
- Growing attention on embodied energy and CO₂ in building materials with plans to be incorporated in the asset labeling in the future



New label incorporating renewable energy:
Local energy generation from renewable energy sources. The system must be installed in the assessed building, or in the same area in which it is located. The systems also must be connected to the building's energy meter, or part of the building they serve.

Source/speaker: Prof. Roberto Lamberts, Federal University of Santa Catarina

14

14



RCUK Centre for Energy Epidemiology

Energy Epidemiology: A New Best Practice Building Energy Model Report Guideline

Dr. Ian Hamilton
Professor in Energy, Environment and Health

EXCo Technical Day
8 November, 2021



1



2

Buildings sector energy use continues to rise

Global direct CO₂ emission reductions by mitigation in building in the net zero energy scenario 2050

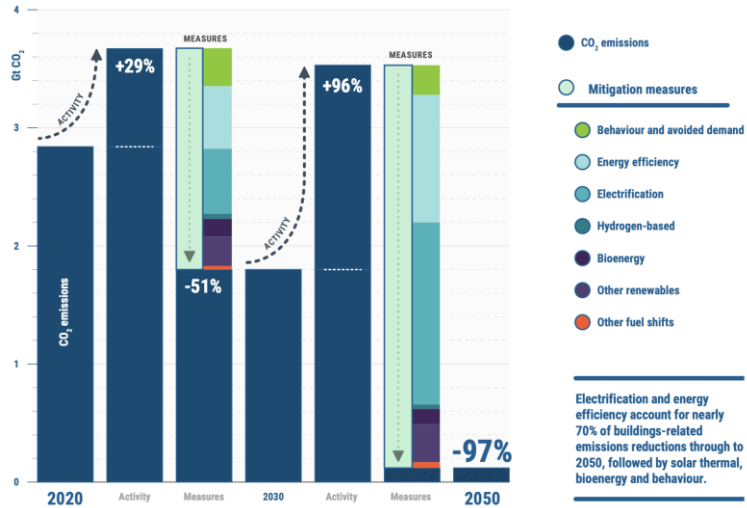

Notes: Activity = change in energy service demand related to rising population, increased floor area and income per capita. Behaviour = change in energy service demand from user decisions, e.g. changing heating temperatures. Avoided demand = change in energy service demand from technology developments, e.g. digitalisation. Sources: IEA 2021c. All rights reserved.

Why change our current research and practice?

Many countries have plans to **significantly reduce energy use** or **improve energy intensity** from the building stock.

Much of this reduction needs to come through more **energy efficient built environments**, which are responsible for almost 36% of global emissions.

Globally energy efficiency refurbishment is estimated to result in the **investments of trillions of dollars**.



Studying the building... as a group



As a population

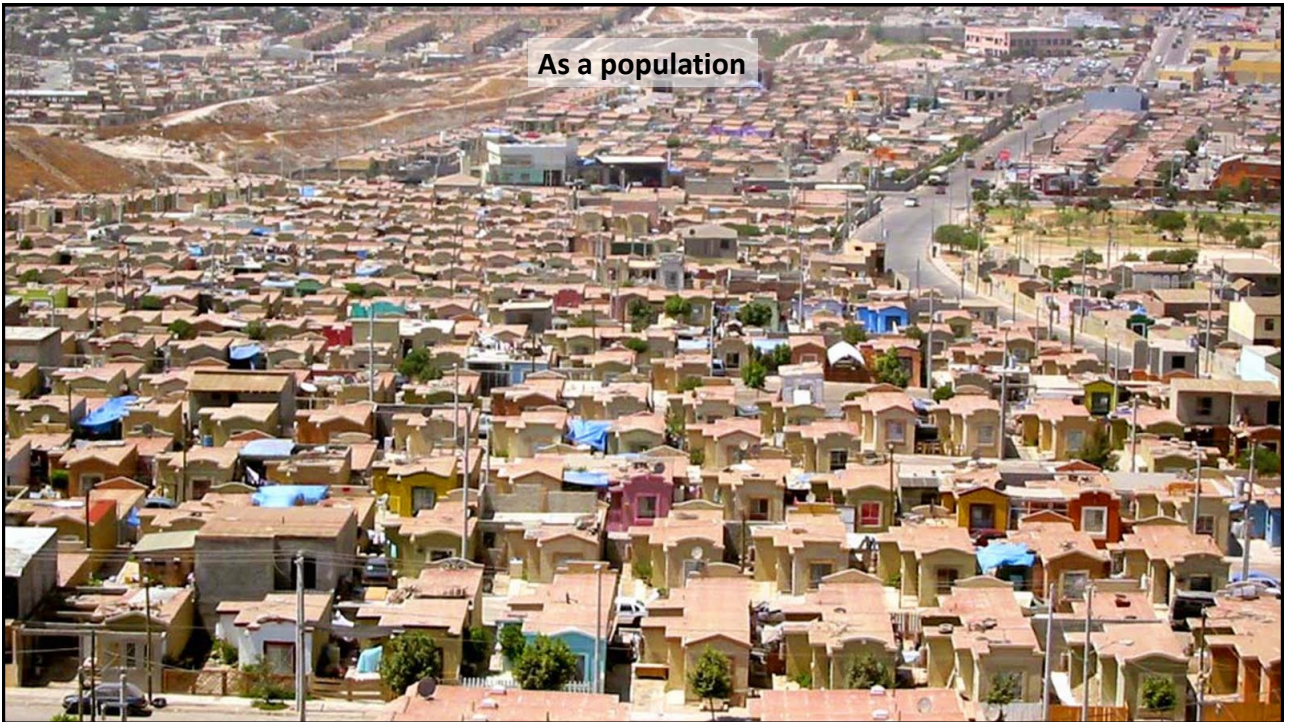

What is 'Epidemiology' and why is it relevant to energy use in buildings?

Epidemiology...

Is **data driven**, emphasis is on empirical evidence, distribution of a condition, understanding of underlying / driving factors

Focuses on understanding what is affecting the **spread and severity** of a condition

Uses research findings to inform **past/future practices and policy**

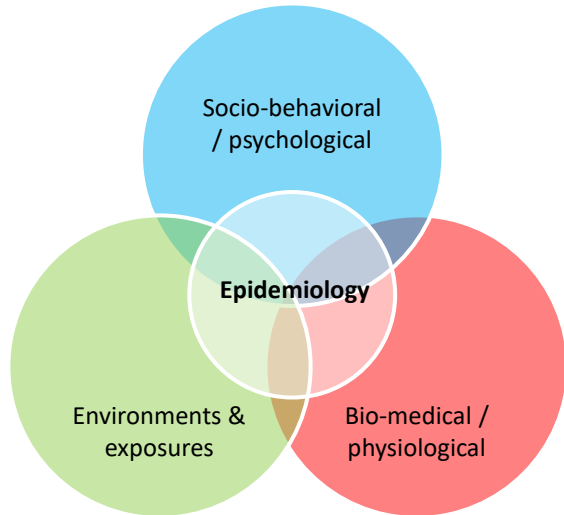

What is energy epidemiology?

epidemiology "epi" - upon; "demos" - the people; "ology" - logic, study. The study of what is upon the people – normally applied to the study of health.

energy epidemiology

The systematic study of the distributions and patterns of energy use and their causes or influences in populations.



How would the research landscape change, if decarbonizing the building stock was treated like a health risk?

Framework for **interdisciplinary** research

Large-scale **population studies** on the distributions of *prevalence and incidence*, and identifying and understanding the factors affecting these distributions, using **empirical data!**

Have established data collection **protocols**, analysis, and archiving as a shared resource, and place detailed studies in context.

Protocols for **feedback of findings** (e.g. failure rates, adverse outcomes, unintended consequences) and **systematic reviews** of evidence

Emphasis on **research translation and engagement** with policymakers and industry as part of an on-going progressive research programme.



How can we better understand building stock models?

Building stock energy models (BSMs) offer a tool to assess the energy demand and environmental impact of building stocks, and can demonstrate and evaluate pathways for reducing their energy demand and respective GHG emissions.

The problem:

The heterogeneity of BSMs, together with a lack of consistency in the description and reporting of the models often hinders the understanding of the model, impeding an accurate interpretation and/or comparison of the results.

The proposal:

Annex 70 have developed reporting guideline in order to improve reporting practices in the field of building stock energy modelling.



How can we better understand building stock models?

Topic	Subtopic	Topic	Subtopic
Overview	Aim and scope	Quality assurance	Calibration
	Modelling ap- proach		Validation
	System boundary		Limitations
	Spatio-temporal resolution		Uncertainty
Model Components	Building stock	Additional information	Sensitivity
	People Environment		Implementation Access
	Energy		Funding and contributors
	Costs Dynamics		Areas of application
Input and outputs	Other aspects		Key references
	Data sources		
	Data processing		
	Key assumptions		

Building Stock Model reporting guidelines

Topic	Subtopic	Guiding questions
Model topics	Overview	Aim and scope What is the overall aim and scope of the model? What are the main use cases addressed?
	Modelling approach	ap- What is the general modelling approach and how is it structured? What are the main model parts and components included in the model and how do they relate to each other? What are the key steps in the modelling workflow?
		System boundary What are the system boundaries (temporal, geographical, building types, energy services, economic sectors, etc.) of the model?
	Spatio-temporal resolution What is the spatio-temporal resolution of the model?	

Detailed descriptions of the model

Key model features



How can we better identify building stock data?

Registry for Building Stock and Energy Data provides a tool for identifying and knowing what data is available around the world among Annex 70 member countries.

The data registry contains information on over 1000 datasets and will be launched in 2022.

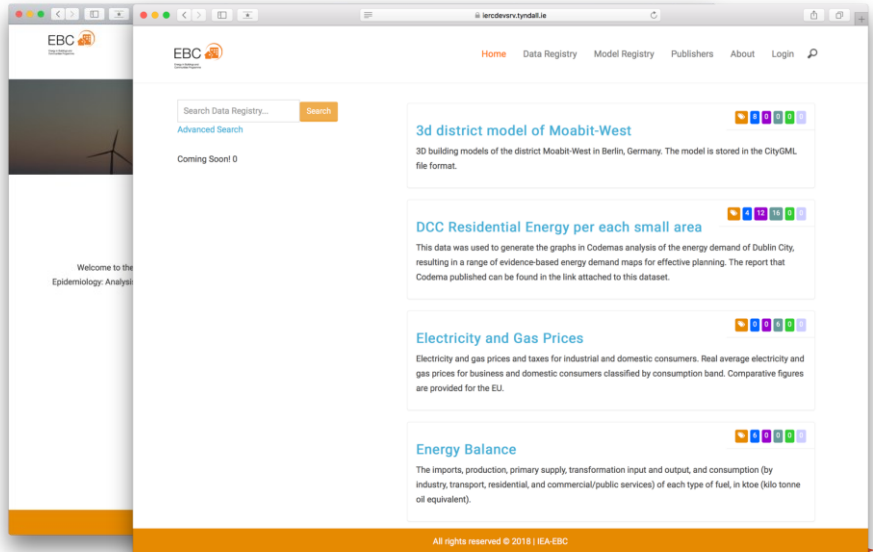

THANK YOU

Ian Hamilton
 Professor in Energy, Environment and Health
 Operating Agent for IEA EBC Annex 70

UCL Energy Institute
 University College London
 i.hamilton@ucl.ac.uk

14 Upper Woburn Place
 London, WC1H 0NN



Data Collection and Use in Japan

EBC Annex70

Professor, Dr. Hiroto TAKAGUCHI
Waseda University

1

Real Recorded Database in Japan

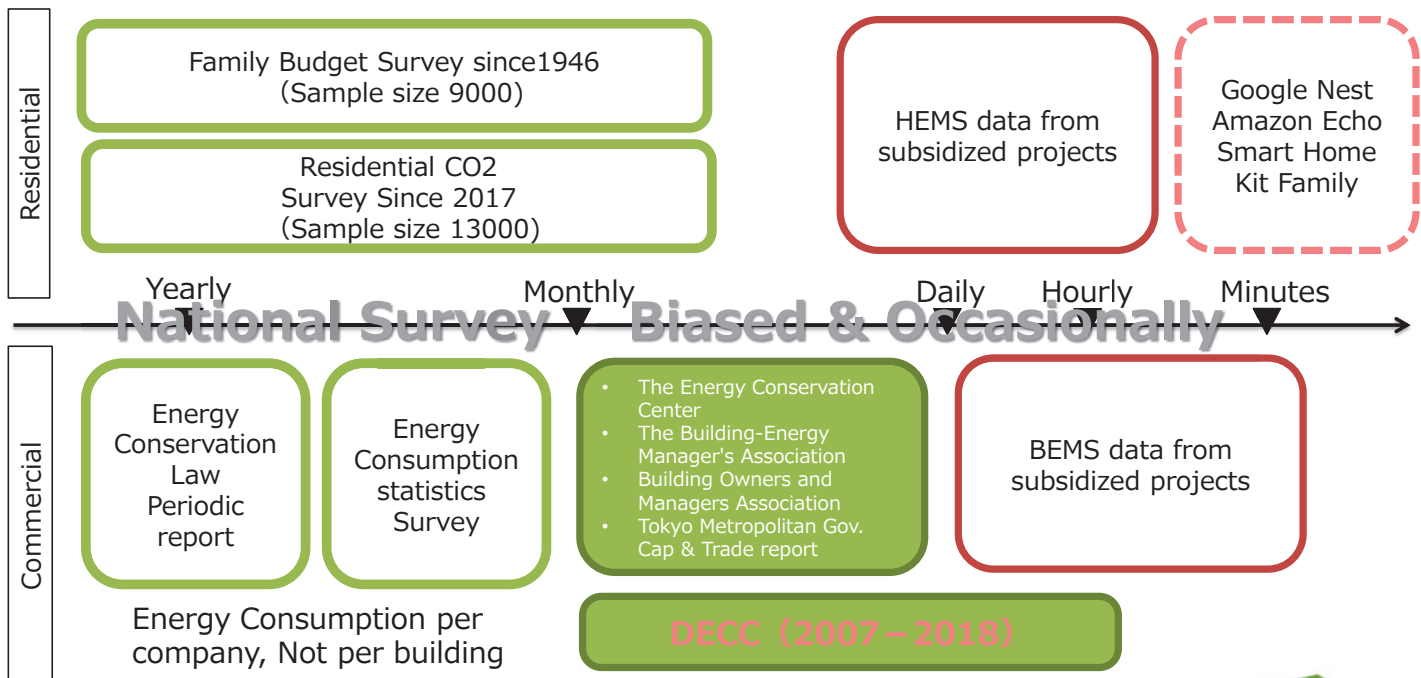

Overview of DECC

DECC is “Data-base for Energy Consumption of Commercial buildings”

- In Japan, there was no database with statistical significance on the environmental data for non-residential building.
- DECC project was started to investigate them in Japan and build a database as a collaborative work with more than 30 universities.
- DECC Committee
 - 2007—2018
- Data collection method
 - Questionnaire by mail (Total 44000 data)
- Goal of the Project
 - Maintain annual, monthly, and hourly data as a database
 - The database should be published not only statistically processed data but also anonymized raw data so that users can freely process it according to their purpose → Open data, big data
 - Data such as building information, equipment information, and usage status should be also collected at the same time to contribute the analysis of energy consumption structure.
 - Ensuring statistical usefulness for the average value of the basic unit
 - Not only the average value but also the basic statistical values such as variance and so on should be published.



<https://www.jsbc.or.jp/decc/>



WASEDA University
Department of Architecture, TAKAGUCHI Laboratory : Environmental Media Study

Who uses these data in Japan (Survey on 2018)

Part of Subtask A, Annex70

User's organization

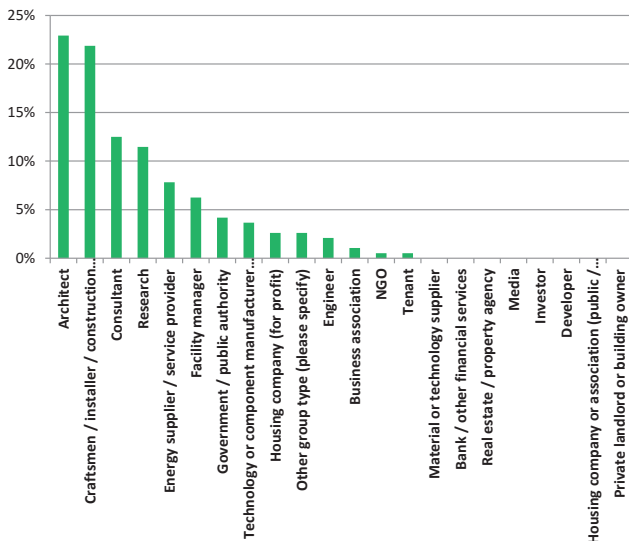

Purpose of data collection

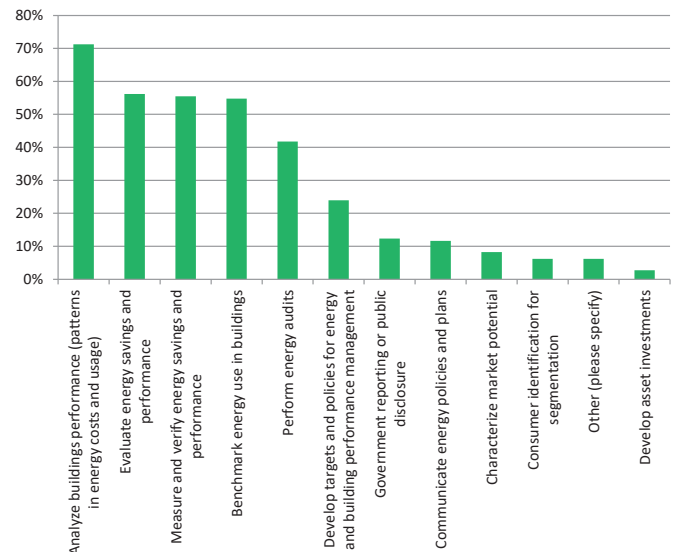

WASEDA University
Department of Architecture, TAKAGUCHI Laboratory : Environmental Media Study

Data types used or needed

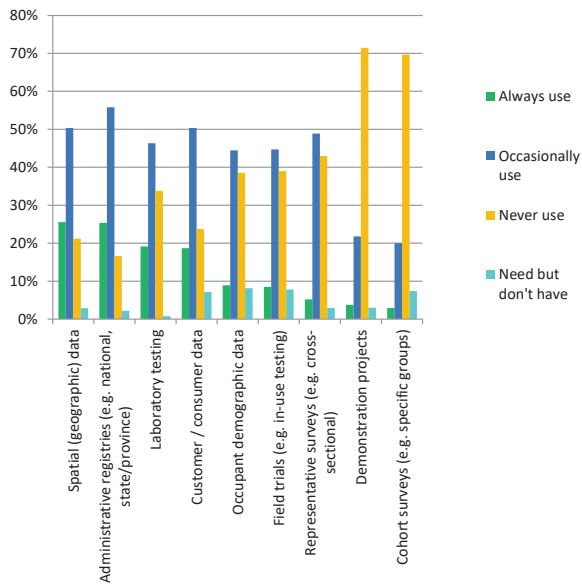

Physical system data used or

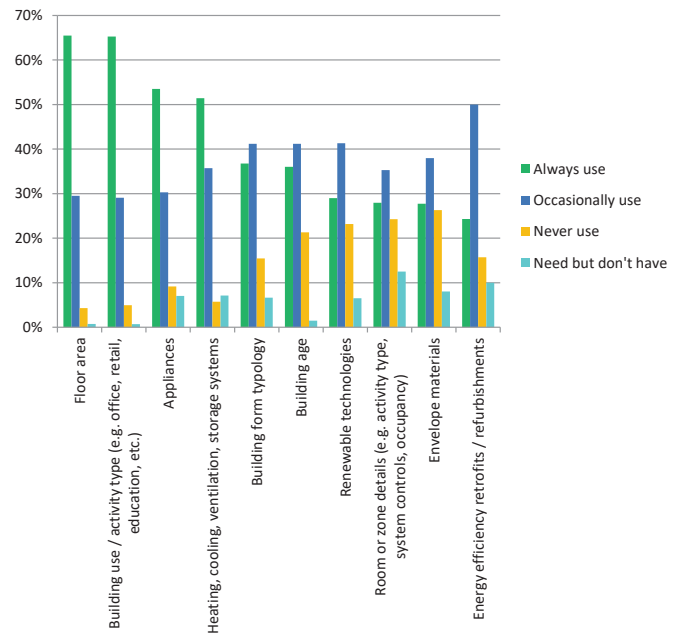

Occupant data used or needed

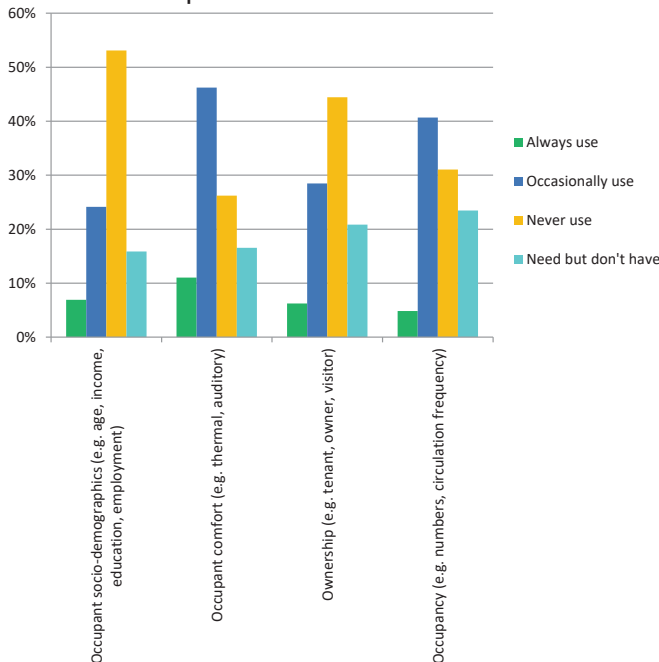

Who are the actors or organizations that could help address your organization's unmet data needs and through what mechanisms?

- Disclosure of data collected by the government
- Census by the Ministry of Land, Infrastructure and Transport
- Volunteer organization's collection
- Collection of BEMS data
- Data disclosure by energy company, like Green button
- Legislation design to limit confidentiality



Building Energy Efficiency Act in Japan, 2016

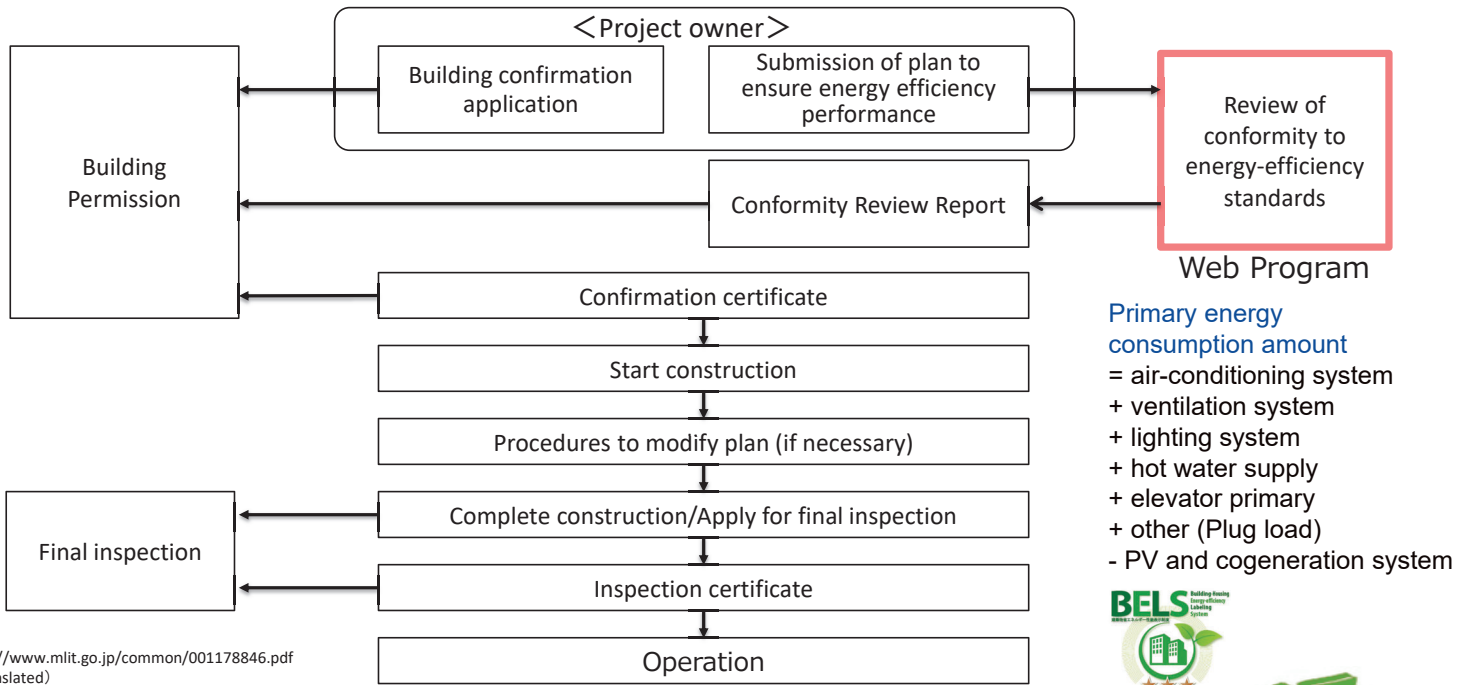

<http://www.mlit.go.jp/common/001178846.pdf>
(Translated)

WASEDA University
Department of Architecture, TAKAGUCHI Laboratory : Environmental Media Study



Building Energy Efficiency Act in Japan 2016

WASEDA University
Department of Architecture, TAKAGUCHI Laboratory : Environmental Media Study

Discussion

- For housing, monthly actual energy consumption data is being accumulated.
- At this moment, there is no comprehensive database for commercial buildings (DECC is dormant)
- BEMS and HEMS data are being accumulated as an obligation of subsidized projects.
- There is no common protocol of measurement data for BEMS and HEMS, so individual analysis work is necessary to use.
- The spread of smart meters has begun to progress.
- Efficient data collection method using smart meter is expected.

Thank you very much



IEA-EBC ANNEX 78: Supplementing Ventilation with Gas-phase Air Cleaning, Implementation and Energy Implications.

Bjarne W. Olesen
Center for Indeklima og Energi
Department of Civil Engineering
Technical University of Denmark

1

ANNEX STRUCTURE Operation Agents

- Dr. Bjarne W. Olesen, Technical University of Denmark.
 - Dr. Pawel Wargocki, Technical University of Denmark.
-
- PREPARATION PHASE 01-07-2018 TO 30-06-2019
 - WORKING PHASE 01-07-2019 TO 30-06-2023
 - REPORTING PHASE 01-07-2012 TO 30-06-2024

2

ANNEX STRUCTURE

- Subtask A: Energy benefits using gas phase air cleaning
 - Subtask leader: Alireza Afshari, Denmark
 - Co-leader: *Sasan Sadrizadeh* , Sweden
- Subtask B: How to partly substitute ventilation by air cleaning
 - Subtask leader: Pawel Wargocki, Denmark
 - Co-leader: Shin-Ichi Tanabe , Japan
- Subtask C: Selection and testing standards for air cleaners
 - Subtask leader: Paolo Tronville, Italy
 - Co-leader: Jinhan Mo, China
- Subtask D: Performance modelling and long-term field validation of gas phase air cleaning technologies
 - Subtask leader: Karel Kabele, Czech
 - Co-leader: Jensen Chang , US

3

Concept for calculation of design ventilation rate ISO CEN ASHRAE

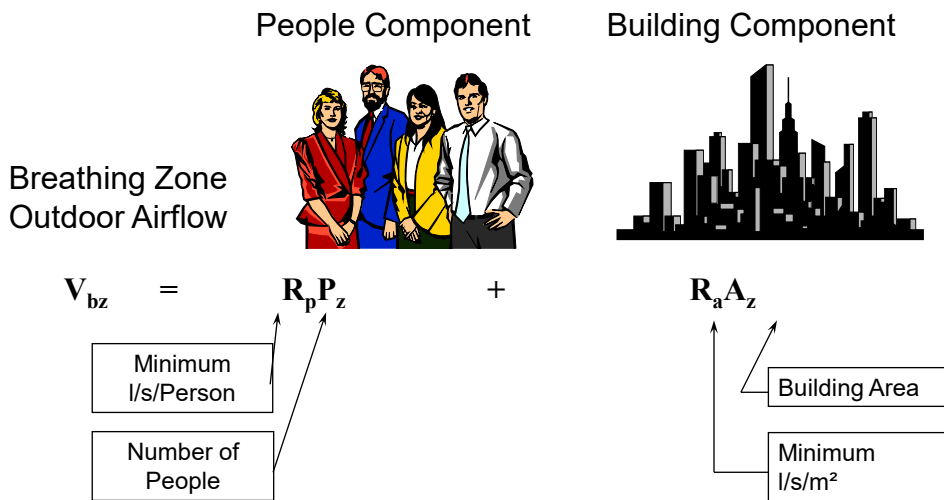

4

Experimental setup

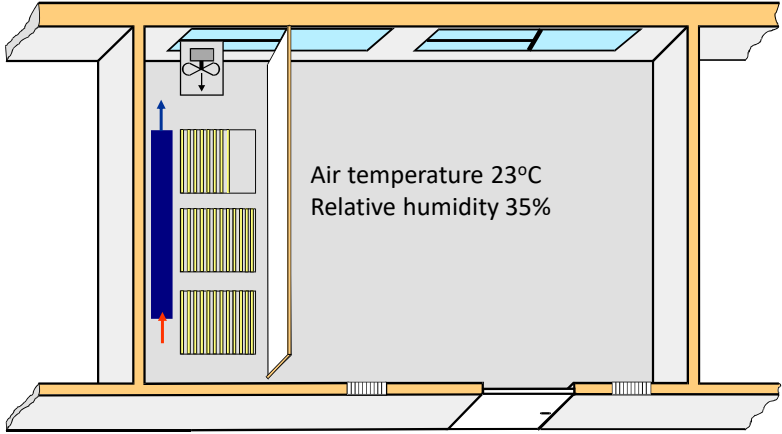

Sensory measurements

- Panel of 50 untrained subjects assessed acceptability of air quality

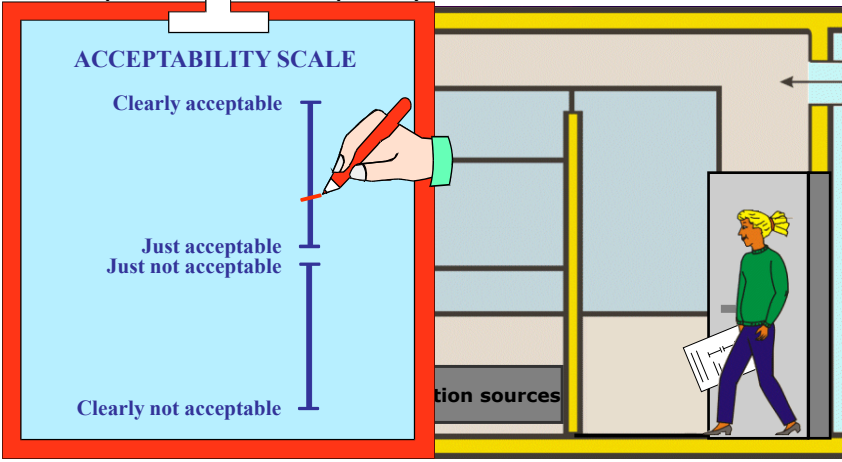

Results: Bldg mat, PCs, filters

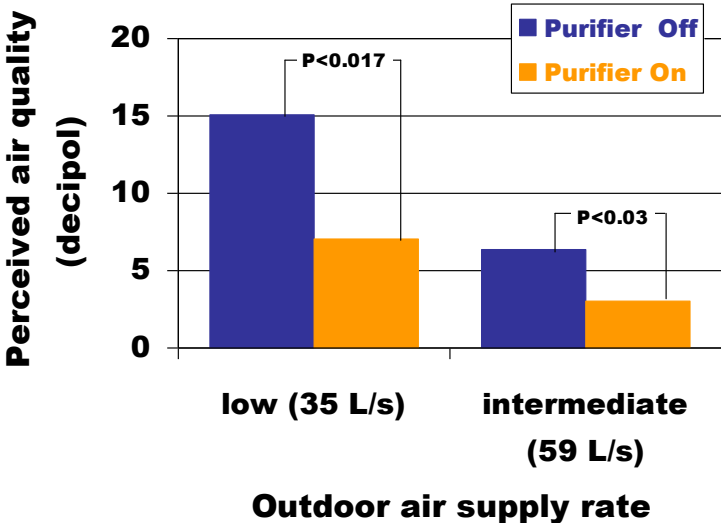

Results: Human bioeffluents

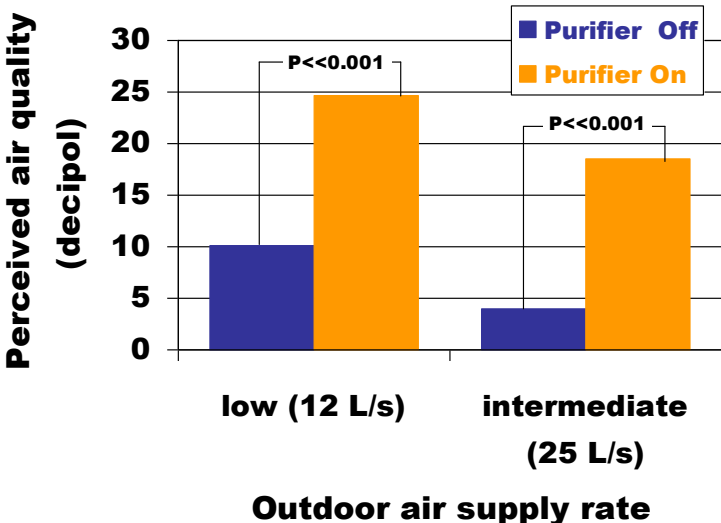

Effect of air cleaning on perceived Air Quality

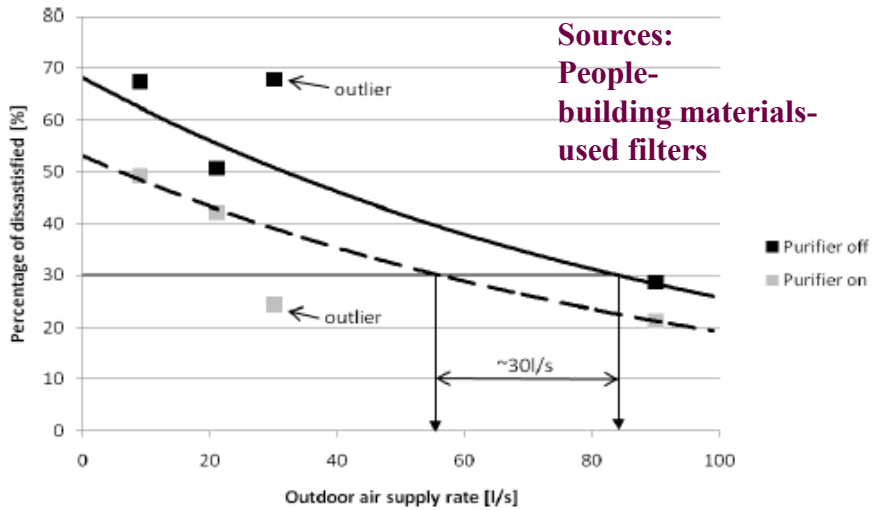

9

Clean Air Delivery rate per person

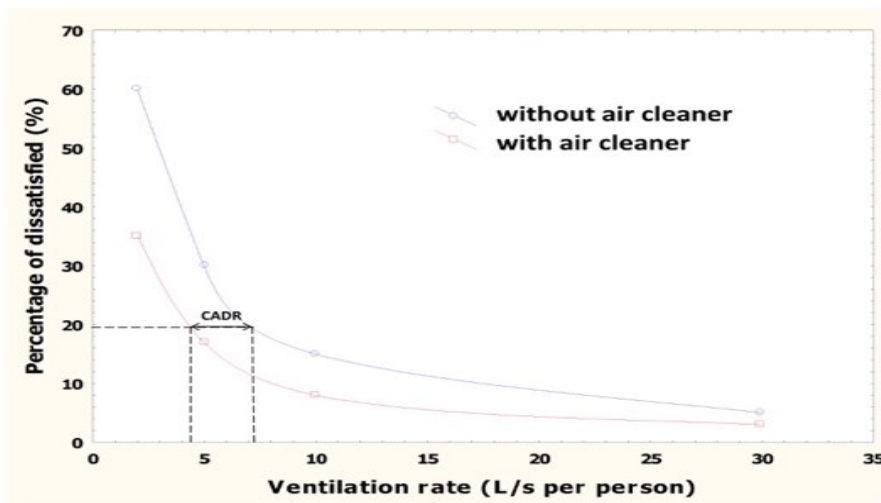

10

• ISO 10121:2014 "Test method for assessing the performance of gas-phase air cleaning media and devices for general ventilation"

INTERNATIONAL
STANDARD

ISO
10121-1

INTERNATIONAL
STANDARD

ISO/FDIS
10121-2

First edition
2014-04-15

Test method for assessing the performance of gas-phase air cleaning media and devices for general ventilation —

Part 1:
Gas-phase air cleaning media

Test methods for assessing the performance of gas-phase air cleaning media and devices for general ventilation —

Part 2:
Gas-phase air cleaning devices (GPACD)

ISO 10121-2:2014

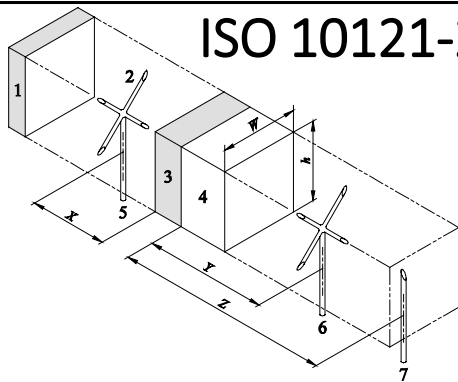

Key

- 1 diffuser and Δp device
- 2 sampling points - should be of "fork" type or similar with multiple inlet points to make a compounded sample over the whole cross section
- 3 GPACD under test
- 4 GPACD section of test duct
- 5 upstream sampling point for T_U , RH_U , p_U and C_U at X mm before the GPACD
- 6 Downstream sampling point for T_D , RH_D , p_D and C_D at Y mm after the GPACD
- 7 Q , air flow rate sampling point at Z mm after the GPACD
- W internal width of the test duct along the GPACD section, 3+4
- h internal height of the test duct along the GPACD section, 3+4

This part of ISO 10121 aims to provide an objective test method to estimate the performance of any full size gas filtration device (GPACD) for general filtration regardless of media or technique used in the device.

To ensure objectivity for test equipment suppliers, no specific design of the test apparatus is specified

This part of ISO 10121 can also be used with technologies such as scrubbers, absorbers, non-sorptive devices or packed columns as long as they fit into the test apparatus, can be meaningfully judged by the test method and are intended for general ventilation applications, both residential and non residential.

Figure 1 — Normative section of test stand showing ducting, measurement parameters and sampling points

Table 2 — Challenge gases and concentrations for the simplified benchmark test

Challenge gas and concentration for the initial efficiency determination (6.3)								
Parameter	Selected gas	Challenge level	Unit	Reference analysis technique	Face velocity [m/s]	T_U [°C]	RH_U [%]	Maximum permissible efficiency decay during test ^b
Acid	SO ₂ ^a	450	ppb(v)	UV fluorescence ^d	2,5	23	50	5 %
Base	NH ₃	450	ppb(v)	chemiluminescence ^d	2,5	23	50	5 %
VOC	toluene	5	ppm(v)	PID ^d or FID ^d	2,5	23	50	5 %
Challenge gas and concentration for the capacity determination (6.4)								
Parameter	Selected gas	Challenge level	Unit	Reference analysis technique	Face velocity [m/s]	T_U [°C]	RH_U [%]	Minimum permissible efficiency decay after 12 h ^c
Acid	SO ₂ ^a	9/90 ^c	ppm(v)	UV fluorescence ^d	2,5	23	50	>10 %
Base	NH ₃	9/90 ^c	ppm(v)	chemiluminescence ^d	2,5	23	50	>10 %
VOC	toluene	9/(90) ^c	ppm(v)	PID ^d or FID ^d	2,5	23	50	>10 %

^a For other acid gases SO₂ may not be representative. In applications for H₂S, NO, NO₂, etc. it may be better to test with the gas in question.

^b A test for initial efficiency should not decay during the test but this may be the case if the selected low concentration is well beyond challenge capacity of the filter. Therefore, a maximum permissible efficiency decay during the initial efficiency test is given. A GPACD not filling this demand may still be tested according to 5.4.

^c The lower or higher concentration is selected depending on filter type/ weight/ purpose/ data sheet. The lower concentration is preferred for toluene while the higher concentration may be needed for all gases to reach the minimum permissible efficiency decay after 12 h.

^d The reference techniques are the ones preferred in this part of ISO 10121. However, other techniques may be used provided that the test supplier can show documented correlation versus the reference technique.

13

EXPRESSION OF PERFORMANCE

- Clean Air Delivery Rate (CADR)

$$CADR = \varepsilon_{PAQ} \cdot Q_{AP} \cdot (3,6/V)$$

where:

Q_{AP} is the air flow through the air cleaner, l/s;
 V is the volume of the room, m³.

Air Cleaning Efficiency

$$\varepsilon_{clean} = 100(C_U - C_D)/C_D$$

where:

ε_{clean} is the air cleaning efficiency;
 C_U is the gas concentration before air cleaner;
 C_D is the gas concentration after air cleaner.

$$\varepsilon_{PAQ} = Q_o / Q_{AP} \cdot (PAQ / PAQ_{AP} - 1) \cdot 100$$

where:

ε_{PAQ} is the air cleaning efficiency for perceived air quality;
 Q_o is the ventilation rate without air cleaner, l/s;
 Q_{AP} is the ventilation rate with air cleaner, l/s;
 PAQ is the perceived air quality without the air cleaner, decipol;
 PAQ_{AP} is the perceived air quality without the air cleaner, decipol

- Higher Air Quality Category

14

EXPRESSION OF PERFORMANCE

- Reduced Energy Use
 - Heating/Cooling of Supply Air
 - Reduced energy for humidification and/or De-humidification
 - Fan Energy
 - Energy Use of Air Cleaner
 - Heat Recovery or not
- Noise level
 - Reduced air flow in AHU
 - Noise from air cleaner
- Draught level
 - Reduced air flow in occupied space
 - Draught from portable air cleaner

15

CO₂ as reference

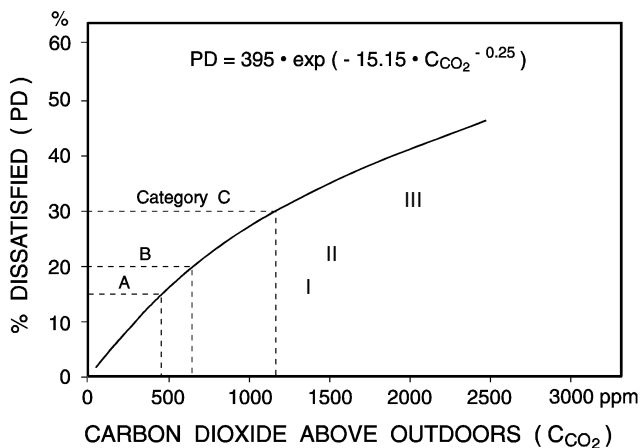

$$Q_h = \frac{G_h}{C_{h,i} - C_{h,o}} \cdot \frac{1}{\epsilon_v}$$

where

- Q_h is the ventilation rate required for dilution, in m³ per second;
- G_h is the generation rate of the substance, in micrograms per second;
- C_h is the guideline value of the substance, in micrograms per m³;
- C_{h,i} is the concentration of the substance of the supply air, in micrograms per m³;
- C_{h,o} is the concentration of the substance of the outdoor air, in micrograms per m³;
- ε_v is the ventilation effectiveness.

16

Issues

- International Standards for Ventilation (Indoor Air Quality) like EN16798-1, ISO17772-1 and ASHRAE 62.1 are mainly based on criteria for the Perceived Air Quality (PAQ), sometimes expressed as levels of CO₂ as a tracer for emission from occupants.
- If air cleaning is used, an equivalent level of air quality will be reached at higher CO₂ concentrations.
- It is also assumed that when ventilation is used for PAQ, the required ventilation will also dilute other substances like Radon, VOCs.
- The decreased ventilation rate when using gas phase air cleaning may not be sufficient.

17

Δ CO₂ levels considering a 30 % reduced ventilation rate due to air cleaners

<i>Space type</i> <i>Single office</i>	<i>Occupancy</i> <i>[m²per person]</i>	<i>Category</i>	<i>Derived from q_{tot}</i>	
			<i>Very low-polluting building</i>	<i>Low-polluting building</i>
			<i>Indoor CO₂ level above outdoor level ΔCO₂ [ppm]</i>	
Without air cleaner	10	IEQ _I	370	278
		IEQ_{II}	529	397
		IEQ _{III}	926	694
		IEQ _{IV}	1389 (1010)	1010 (794)
With air cleaner	10	IEQ _I	529	397
		IEQ_{II}	756	567
		IEQ _{III}	1323 (1029)	992 (817)
		IEQ _{IV}	1984 (1100)	1443 (911)

18

Issues

- Today, gas phase air cleaners are tested based on a chemical measurement, which do not account for the influence on PAQ and human bio effluents as a source of pollution.
- Studies have shown that some gas phase air cleaning technologies will not work when humans are the source, and the evaluation is done by PAQ.
- There is a need for new test standards
- Testing with PAQ requires a measurement of subjective reactions
- Testing with human bio effluents as a source requires the use of humans as a source

19

Testing Issues

- If only a test with chemical measurements is done, should it be allowed to reduce the building component?
- How to standardise the building source?
- How to standardise the human bio effluent source?
- It is a relative measurement, which makes some of the issues less important
- A test method using PAQ is voluntary; but will give the industry a possibility to show that their air cleaner can improve the IAQ and the ventilation rate can be decreased.

20

IEA EBC Annex 78

Test method for measuring perceived indoor air quality for use in testing the performance of gas phase air cleaning products



Shin-ichi Tanabe, Prof. Dr.
President, Architectural Institute of Japan
Waseda University

Shin-ichi Tanabe, Waseda University, all right reserved 2021

1

- **Indoor air — 16000**
**Part 44: Test method for measuring
perceived indoor air quality for use in
testing the performance of gas phase
air cleaners**
(DIS voting stage)

2



ISO/TC 146/SC 6 Indoor Air

Scope of ISO/TC 146/SC 6

- Standardization of any matters within the scope of ISO/TC 146 dealing with **indoor air**
- Gases, particles, odours, micro-organisms, and emissions from building products and furnishings
- **Definition of the indoor environment:**
Dwellings, having living rooms, bedrooms, DIY rooms, recreation rooms and cellars, kitchens and bathrooms;
workrooms or work places in buildings which are not subject to health and safety inspections in regard to air pollutants (for example offices, sales premises);
public buildings (for example hospitals, schools, kindergardens, sports halls, libraries, restaurants and bars, theatres, cinemas and other function rooms);
cabins of vehicles



3

3



ISO/ TC 146/SC 6 – Member Countries

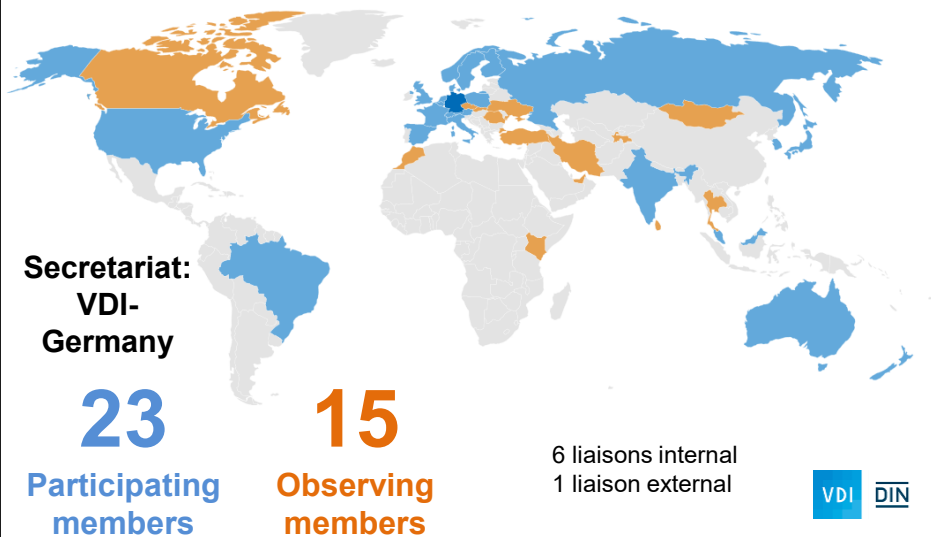

4

4



ISO Standards on Indoor Air Quality

Total Number: **53** (**50** published)

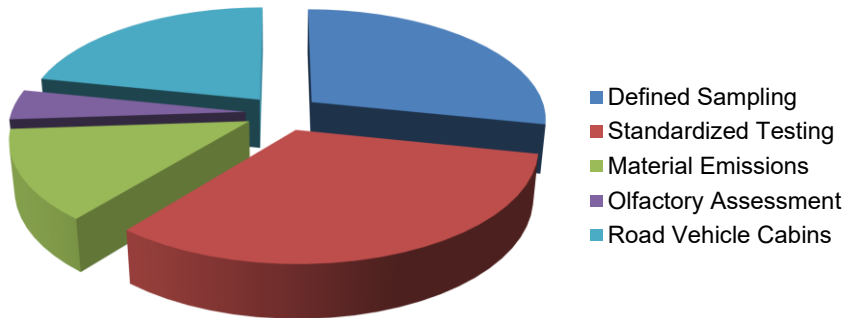

5

5

New Liaison



✓ Resolution 509 (2021)

ISO/TC 146/SC 6 decides to start a liaison with **IEC/TC 59 JWG 17** dealing with household and similar air treatment electrical appliances.

IEC: International Electrotechnical Commission

IEC/TC 59 JWG17: Household and similar air treatment electrical appliances (ISO TC142)

6

6

Scope (Draft)

- ✓ This part of ISO 16000 specifies a general laboratory test method for **measuring perceived air quality** that is applied for assessing the performance of air cleaners for gas-phase pollutants.
- ✓ Perceived air quality is evaluated by human subjects (panels). **This method applies to gas phase air cleaners**, and can be performed in laboratories. Only gas-phase pollutants that can be sensed by human subjects are considered.
- ✓ This document is based on sensory test specified in **ISO 16000 28 (building products)** and **ISO 16000 30 (indoor air)**, and is harmonized with the standard for testing gas phase air cleaners that will be standardized by **ISO/TC 142 (Cleaning equipment for air and other gases)**.

7

Test Chamber Method

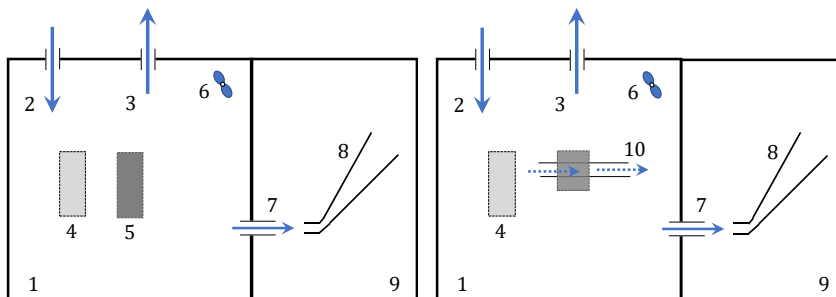

1. Test chamber/room
2. Clean and temperature/humidity conditioned air supply
3. Exhaust outlet
4. Odour emission source(s)
5. Air cleaner(s)
6. Mixing fan
7. Tube or duct
8. Sniffing device, complying with relevant specifications and requirements of ISO 16000-28.
9. Front/anterior space in which human panel enter
10. In duct air cleaner(s)

8

Acceptable scale

Perceived odour intensity with category scale

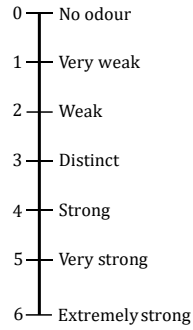
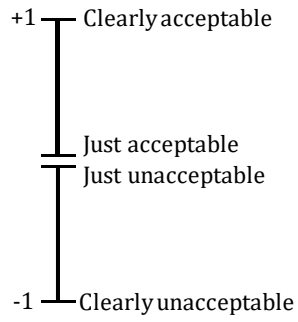

Annex81: Data Driven Smart Buildings

Data Driven Smart Buildings

Stephen White (Operating Agent, CSIRO, Australia)

IEA Technology Collaboration Programme on Energy in Buildings and Communities Webinar
“Building Energy Efficiency and Indoor Air Quality”

9th November 2021, 12:00-15:00 UTC / GMT

1

Data-Driven Smart Buildings

Why are we interested?

- Poorly maintained and improperly controlled HVAC equipment wastes up to 30% energy
- HVAC offers a large untapped resource of flexible load that can support increased use of variable renewable electricity sources
... and other bundled comfort and productivity services

Can ‘digitalization’ unlock energy savings and flexible demand?

FDD savings and costs snapshot

	Year 1	Year 2
Median savings	6%	9%
Median savings (\$/sf/yr)	\$0.17	\$0.24

Costs	Per point	Per building	Per sq ft
Base software and installation (one-time cost)	\$8	\$12,500	\$0.05
Annual software + MBCx service provider (\$ per year)	\$5	\$3,503	\$0.02

Many additional results on measures IDd, enablers, barriers, payback ...



US DoE Smart Energy Analytics Campaign

- 104 organizations, 6500+ buildings
- ~2 year payback time

2

What is Digitalization/ Industry 4.0/ Smart-Building?

- Energy meter
- IoT sensors and devices
- BMS
- Geospatial

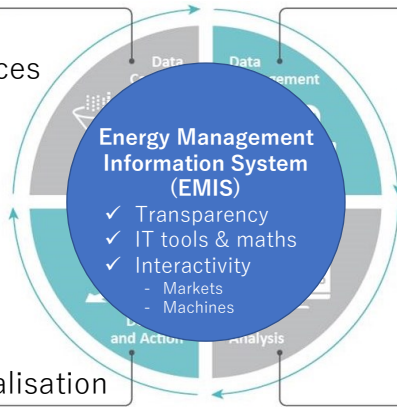

- Data federation
- Semantic data models
- Access controls

- Product dispatch
- Automated settlement
- Human interfaces & visualisation

- ✓ Model Predictive Control
- ✓ Fault Detection and Diagnosis
- ✓ Grid Interactive Buildings

“Platform” for multi-stakeholder participation

IEA Technology Collaboration Programme on Energy in Buildings and Communities Webinar, Nov. 2021

3

Barriers to realising savings from digitalization

Data/System Integration Barriers

- Poor hardware/software interoperability
- Lack of standards for managing data
- Cyber security, privacy and data-leakage fears
- IT dept. engagement and conservative industry structure

Skills Barriers

- Lack of system-integration skills
- Diverse hardware/software implementation practices

Commercial Barriers

- Commercial lock-in/ purchasing fears
- Siloed product offerings
- Lack of innovation/ narrow range of services
- Lack of clarity regarding the value for stakeholders

What are the barriers to smart-building technologies?

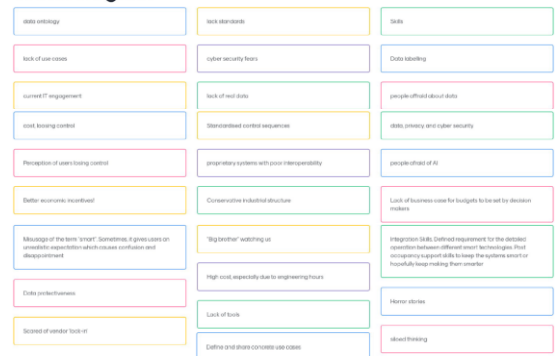

Poorly understood concept of a “digital-ready” building
Not packaged up as a clear “product” that anyone can buy or train for

IEA Technology Collaboration Programme on Energy in Buildings and Communities Webinar, Nov. 2021

4

Our role

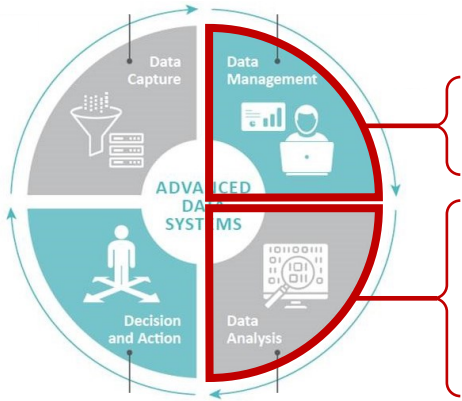

- ✓ Community of practice: networking and knowledge sharing
- ✓ Support the development of data management standards & platforms
- ✓ Transparent software “Application” benchmarking
- ✓ Drive innovation and value in data-driven services
 - Data sandpits
 - Competitions

The Annex

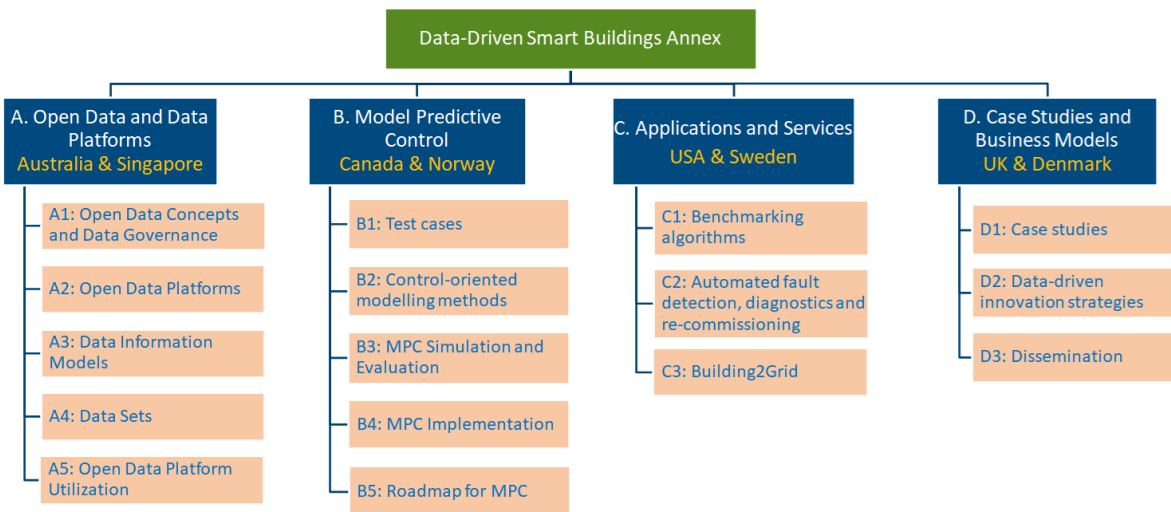

Competitions

The poster for the Global AI Challenge features the EMSD logo at the top left. The main title is 'Global AI Challenge' with a subtitle 'For Building EM Facilities'. Below the title, there are four highlighted activities: 'Data Query' (to extract building data from a building), 'Workshop' (to provide hands-on data analysis and quarterly applications), 'Cooling Demand Prediction' (to energy prediction models for cooling demand), and 'Innovation Ideas Pitching' (to provide an innovative proposal that enhances cooling demand prediction). A section for 'Resources provided for participants' lists 'About 2 years of building data', 'Workshop', and 'Networking'. At the bottom, it states 'Total more than US\$150,000 prizes for winners!!' and lists the schedule: 'Global Conference' on Oct 2021, 'AI Competition' from Sep 2021 - Mar 2022, 'Workshop', and 'Awards Ceremony'.

This block contains the logos for 'Smart Energy Systems ERA-Net' and 'MICall20'. The ERA-Net logo features a stylized green leaf and blue circle. The MICall20 logo includes the text 'MISSION INNOVATION' and 'accelerating the clean energy revolution'.

The screenshot shows the website for 'THE CITYLEARN CHALLENGE', described as 'MULTI-AGENT REINFORCEMENT LEARNING FOR INTELLIGENT ENERGY MANAGEMENT'. It features a navigation bar with 'Home', 'Environment', 'Scoring', and 'Pre-'. Below the header, there are 'Sign-up' and 'CityLearn GitHub' buttons. A central announcement states: 'The CityLearn Challenge 2021 has now concluded! The winners and the leaderboard will be announced at the RLEM workshop: <https://rlem-workshop.net/>'. A note at the bottom says 'Note: Non-author registration is free for the online workshop and BuildSys'. Logos for 'Onboard', 'The University of Texas at Austin Machine Learning Laboratory', 'The University of Texas at Austin Energy Institute', 'RASEI', and 'INREL' are displayed at the bottom right.

IEA Technology Collaboration Programme on Energy in Buildings and Communities Webinar, Nov. 2021

7

What does success look like?



- Imagine if you could download energy efficiency tools like you download an “App”?
- Who would like to go first?

IEA Technology Collaboration Programme on Energy in Buildings and Communities Webinar, Nov. 2021

8

8

Annex81: Data Driven Smart Buildings

Japan's Activities and Challenges

Yasunori AKASHI (Professor, The University of Tokyo)

IEA Technology Collaboration Programme on Energy in Buildings and Communities Webinar
“Building Energy Efficiency and Indoor Air Quality”

9th November 2021, 12:00-15:00 UTC / GMT

Annex81: Data Driven Smart Buildings

Japan's Activities and Challenges

Yasunori AKASHI (Professor, The University of Tokyo)

IEA Technology Collaboration Programme on Energy in Buildings and Communities Webinar
"Building Energy Efficiency and Indoor Air Quality"

9th November 2021, 12:00-15:00 UTC / GMT

1

Participation in Annex81

■ Three main motivations for Japan's participation

- Urgent issue for **decarbonization** of buildings
- Importance of **data driven operation** in **existing** buildings
- Deeply related to the creation of **new value and business** in the field of building services

■ Domestic committee for Annex 81

- 13 companies, 1 NPO, 2 universities (20 people)

	Industry/Univ., NPO	Affiliation	Number of People
Chairperson & Secretaries	University	The University of Tokyo, Tokyo Denki University	3
	NPO	Building Services Commissioning Association	1
Members	Design	NIKKEN SEKKEI, NTT Facilities, P.T.Morimura & Associates	4
	Construction	Dai-Dan, Kyudenko, Shinryo, Takasago Thermal Engineering, TONETS	7
	HVAC Manufacturer	DAIKIN	1
	Automatic control	Azbil	1
	Energy	Kansai Electric Power, OSAKA GAS, Tokyo Electric Power	3

2

Example 1 from Japan #1

■ In the meetings of Annex81, we provided **two examples in Japan on data-driven operations** in building systems.

■ Example 1: Commissioning(Cx) of Kyoto Station Building

- A complex building (station, hotel, department store, theater, etc.) with the total floor of about 23,600m² (built in 1997)
- Fully applied the Cx process to the large-scale water-side system retrofit project (2010-2019)
- First case of business-based Cx implementation with Cx fees in Japan
- The energy saving of 60% targetd in the OPR has been achieved
 - 8% reduction has been achieved using the measured data of EMS in the FPT and operational optimization during the first three years after the completion

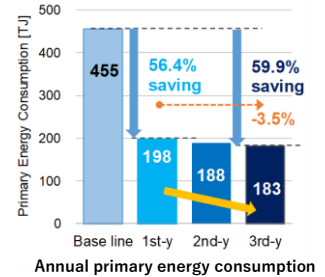

Award

- The Energy Conservation Grand Prize, METI Minister Award (Grand prix) 2020
- ASHRAE Technology Award 2021, First Place

Example 1 from Japan #2

■ For the aspects of simulation and data-driven operation in this example,

- Development of the detailed simulation with automatic controls
- Development of the applications for the optimal control logic of the chillers using the simulation
- These applications and the data of EMS optimize the actual operation, resulting in the additional 8% energy saving.

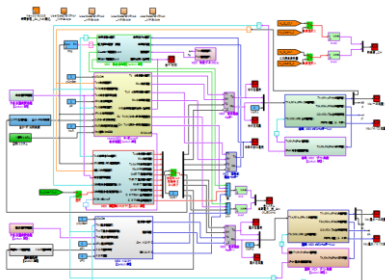

Simulation originally developed by the Cx provider (Prof Emer. Yoshida, Kyoto Univ.)

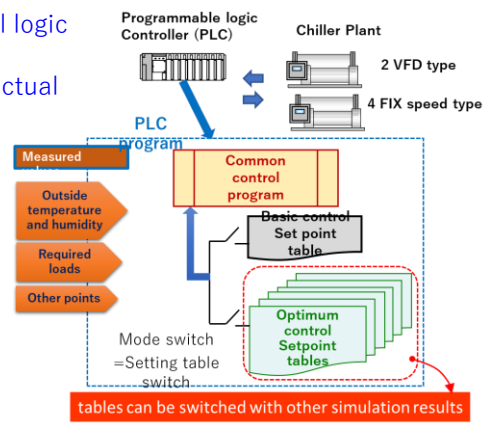

Developed the optimal control setpoints tables

Example 2 from Japan #1

Example 2: Automated Fault Detection and Diagnosis (AFDD) in a HVAC water-side system of a semiconductor plant

- Conventional manual FDD and optimization are extremely inefficient, so they are rarely implemented, including in general building systems.
 - Since it is not possible to know in advance which faults are occurring, it is necessary to check all data in the end.
- However, some reports indicate that the FDD and operational optimization can reduce building energy consumption of 10-30%.

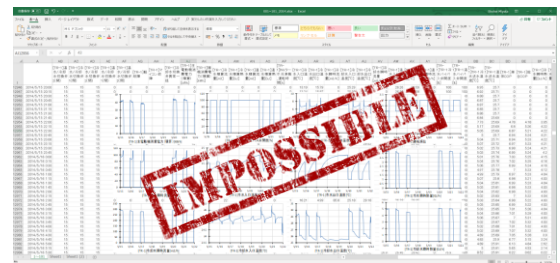
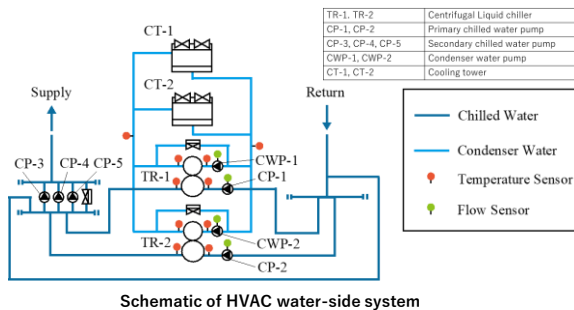

Example 2 from Japan #2

For the aspects of simulation and data-driven operation in this example,

- Development of the detailed simulation with automatic controls
- Development of the applications for AFDD using the simulation and machine learning
- Now, these applications are being demonstrated in the actual system to verify the effectiveness of the AFDD method.

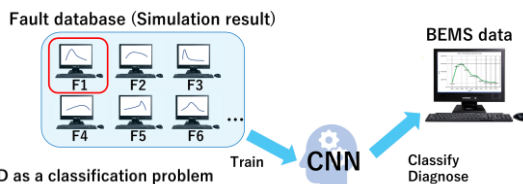
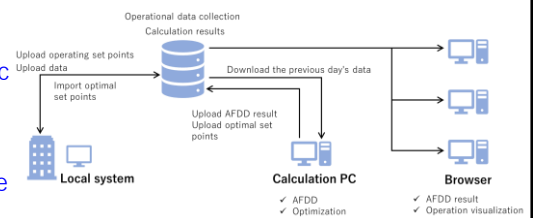

- Simulation to calculate faulty behavior
- Convolutional Neural Network (CNN) learns the features of faults and diagnoses the measured data.
- AFDD results was verified by manual data analysis.

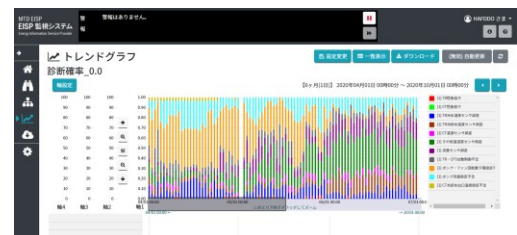

- AFDD result from EMS data
- Demonstration system is running everyday

What we learned from the examples/Annex81 for Japan

- **Data and applications** can improve building energy performance in the operation.
- Various data and applications need to be utilized in buildings **on a plug-and-play basis**. It will **upgrade building energy performance** according to the building usage.
- In Japan, there is **very little use** of such data and applications. The construction industry in Japan is just **at the tipping point**.
 - An **open platform** is still not used in most buildings.
 - A Cloud EMS is used in each example, but it **does not have mechanism to efficiently manage** large amounts of data such as a Graph DB.
- **Important points** for promoting decarbonization of existing buildings
 - **Developing data-driven system** that can be installed relatively easily during retrofit or normal time,
 - **Making building owners and occupants understand** the value of installing the technologies with the value of data-driven smartification,
 - **Human resources** for system integration and application development

